

SP

Submersible pumps, motors, and accessories
60 Hz



be
think
innovate

1. Product introduction	3	7. Electrical data	98
Introduction	3		
Applications	3	8. Accessories	99
Features and benefits	3	MP 204	99
Identification	8	Control functions	102
		Connecting pieces	104
2. Product overview	10	Zinc anodes	104
Performance range 60 Hz	10	SA-SPM 6 control boxes	105
Pump range	11	Pt100	106
Motor range	11		
Motor protection and controllers	11	9. Energy consumption	107
		Energy consumption of submersible pumps	107
3. Construction	12		
Sectional drawing, SP pump		10. Cables	108
4" spline shaft (SP 5S - 25S)	12	Cable sizing charts	109
Sectional drawing, SP pump			
4" smooth shaft (SP 35S - 77S)	13	11. Friction loss tables	113
Sectional drawing, SP pump			
6" (SP 85S - 300S)	14	12. Further product documentation	115
Sectional drawing, SP pump		Grundfos GO	116
8" (SP 385S - 475S)	15		
Sectional drawing, SP pump			
10" (SP 625S - 1100S)	16		
Sectional drawing, MS motors	17		
Sectional drawing, MMS motors	18		
4. Operating conditions	19		
Operating conditions	19		
Curve conditions	19		
5. How to read the curve charts	20		
6. Curve charts and technical data	21		
4" and larger wells	21		
SP 5S (5 gpm)	21		
SP 7S (7 gpm)	23		
SP 10S (10 gpm)	25		
SP 16S (16 gpm)	27		
SP 25S (25 gpm)	29		
SP 35S (35 gpm)	31		
SP 45S (45 gpm)	36		
SP 62S (62 gpm)	41		
SP 77S (77 gpm)	45		
6" and larger wells	49		
SP 85S (85 gpm)	49		
SP 150S (150 gpm)	55		
SP 230S (230 gpm)	61		
SP 300S (300 gpm)	67		
8" and larger wells	73		
SP 385S (385 gpm)	73		
SP 475S (475 gpm)	78		
10" and larger wells	83		
SP 625S (625 gpm)	83		
SP 800S (800 gpm)	88		
SP 1100S (1100 gpm)	93		

1. Product introduction

Introduction

The Grundfos SP range of submersible pumps is renowned for high efficiency and reliability. Made entirely of corrosion resistant stainless steel, SP pumps are ideal for a wide variety of applications.

Grundfos SP pumps represent state-of-the-art hydraulic design. Built to deliver optimum efficiency during periods of high demand, SP pumps provide low long-term costs and high operating reliability regardless of the application.

The SP range offers high efficiency, high resistance to sand and other abrasives, motor burnout protection, and easy maintenance. A complete monitoring and control system is available for constant optimization of the pumping system.



Fig. 1 Grundfos SP pumps

TM06 4950 3315

Applications

Grundfos Large SP submersible pumps are suitable for:

- Groundwater supply to waterworks
- Irrigation in horticulture and agriculture
- Groundwater lowering (dewatering)
- Pressure boosting
- Industrial applications
- Domestic water supply.

Pumped liquids

Grundfos SP pumps are suitable for pumping clean, thin, non-aggressive liquids without solid particles or fibers.

SP offers stainless steel construction which ensures good wear resistance and a reduced risk of corrosion where the water has minor chloride content.

Optional, upgraded stainless steel construction is available for pumping more aggressive liquids:

- A complete range of zinc anodes for cathodic protection is available; see p. 97 for applications (for example, sea water applications).
- For slightly polluted liquids (for example, containing oil), Grundfos offers a complete range of stainless steel SP NE pumps with all rubber parts made of FKM.

Features and benefits

Grundfos SP submersible pumps offer these features and benefits:

- State-of-the-art hydraulics provide high efficiency and low operating costs
- 100 % stainless steel components inside and outside for long service life
- Sand resistant
- Resistant to aggressive water
- Dry-running protection
- Monitoring, protection and communication via
 - protection unit MP 204
 - Grundfos GO.

A wide pump range

Grundfos offers energy-efficient SP submersible pumps with a performance range of up to 1,400 gpm and 2,100 ft of head.

The pump range consists of many pump sizes, and each pump size is available with an optional number of stages to match any duty point.

High pump efficiency

Often pump efficiency is given less consideration than the price of a pump; however, owners who choose efficiency will find substantial savings in energy costs over time. See fig. 2 for an illustration of SP efficiencies in relation to flow.

Example

For example, a pump and motor with a 10 % higher efficiency than a cheaper, less efficient pump, can save its owner more than \$80,000.00 over 10 years*.

* If producing 880 gpm at 325 ft of head for 10 years @ 13.8 cents per kWh. U.S. kWh costs range from 6 cents to more than 20 cents, depending on region.

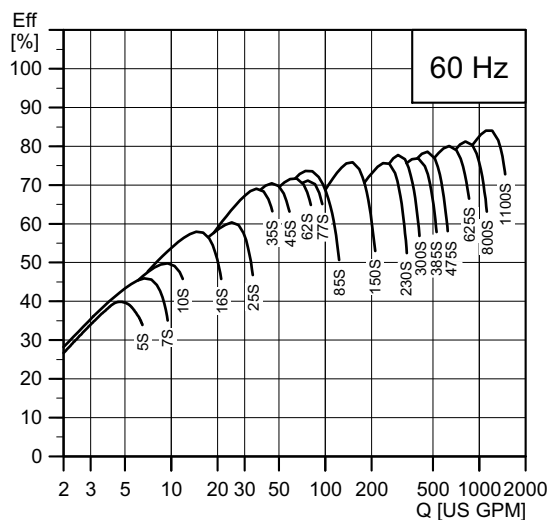

Fig. 2 SP pump/motor efficiencies in relation to flow

TM05 0057 3215

Pump design

Grundfos SP submersible pumps feature components that contribute to the superior performance and durability of the range.

Lower installation costs

Stainless steel means low weight for ease in the handling of pumps, resulting in lower equipment costs and reduced installation and service time.

Bearings with sand channels

All bearings are water-lubricated and have a squared shape enabling sand particles, if any, to leave the pump together with the pumped liquid.

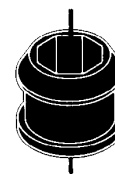

Fig. 3 Bearing

TM00 7301 1096

Inlet strainer

The inlet strainer prevents particles over a certain size from entering the pump.



Fig. 4 Fig. Inlet strainer

TM00 7302 1096

Check valve

All pumps are equipped with a reliable check valve in the valve casing preventing back flow in connection with pump stoppage.

Furthermore, the short closing time of the check valve means that the risk of destructive water hammer is reduced to a minimum.

The valve casing is designed for optimum hydraulic properties to minimize the pressure loss across the valve and thus to contribute to the high efficiency of the pump.

Note: As shown in fig. 5 the check valve is spring assisted intended for vertical pump applications. When installing pump at an angle, installation requires an additional check valve installed in the discharge piping. This prevents misalignment or failure to seat the pump check valve at an angle. Additional check valve in discharge piping sold separately.

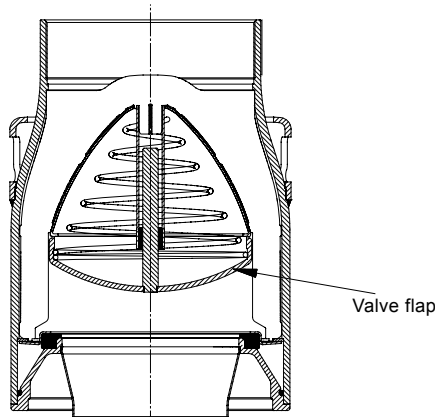

TM01 2499 1798

Fig. 5 Check valve

Priming screw

All Grundfos 4" pumps are fitted with a priming screw. Consequently, dry running is prevented, because the priming screw will make sure that pump bearings are always lubricated.

Due to the semi-axial impellers of large SP pumps this priming is provided automatically.

However, it applies to all pump types that if the water table is lowered to a level below the pump inlet neither pump nor motor will be protected against dry running.

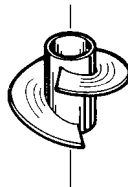

TM00 7304 1096

Fig. 6 Priming screw

Stop ring

The stop ring prevents damage to the pump during transport and in case of up-thrust in connection with start-up.

The stop ring, which is designed as a thrust bearing, limits axial movements of the pump shaft.

Example: SP 385S

The stationary part of the stop ring (A) is secured in the upper intermediate chamber.

The rotating part (B) is fitted above the split cone (C).

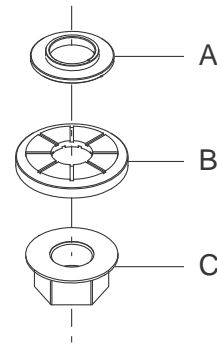

TM01 3327 0412

Fig. 7 Stop ring (rotating and stationary part) and the split cone

Grundfos submersible motors

A complete motor range

Grundfos offers a complete submersible motor range in different voltages. For an overview of motor types, sizes and voltages, see page 98.

- MS 402 is designed for the domestic ground water market and covers outputs.
- The MS 4000 and MS 6000C series are designed for use in a variety of applications in water supply. When equipped with features like oversized motor, temperature measurement, cooling jacket, and SiC/SiC mechanical shaft seals, these motors are suitable for heavy-duty industrial applications such as dewatering operations.

As a standard, all external surfaces of the Grundfos MS motors in contact with water are made of AISI 304 stainless steel. For aggressive water, such as seawater or brackish water, R versions made of AISI 904L are available.

Grundfos rewindable MMS motor range

Grundfos MMS motors are suitable for any submersible installation, including heavy-duty industrial applications and dewatering operations (when equipped with temperature control, oversized motor, cooling jacket, and SiC/SiC mechanical shaft seals).

As standard the MMS motors are supplied with black cast-iron end-bells. Optionally, the range is available in all-stainless steel AISI 316 or AISI 904L versions.

The 2-pole Grundfos MMS submersible motors are all easy to rewind. The windings of the stator are made of a special waterproof wire of pure electrolytic copper sheathed with special non-hydroscopic thermoplastic material. The fine dielectric properties of this material allow direct contact between the windings and the liquid for efficient cooling of the windings.



Fig. 8 Grundfos MS motors

TM00 7305 1096 - Gr/A4011 - Gr/A4013



Fig. 9 Grundfos MMS motors

TM03 3478 0406

Industrial submersible motors and MS 6000C T60 versions

For heavy-duty applications Grundfos offers a complete motor range of industrial motors with up to 5 % higher efficiency than that of Grundfos' standard motors.

The cooling of the motor is very efficient due to the large motor surface. The efficient cooling makes it possible to increase the liquid temperature to 140 °F (60 °C) at a minimum flow of 0.49 fps (0.15 m/s) past the motor.

The industrial motors are for customers who value low operating costs and long life higher than price.

Grundfos industrial motors are developed for difficult operating conditions. These motors will stand a higher thermal load than standard motors and thus have a longer life when subjected to high load. This applies whether the high load is caused by bad power supply, hot water, bad cooling conditions, high pump load etc. Please note that heavy duty motors are longer than motors for standard conditions.

Overtemperature protection

Accessories for protection against overtemperature are available for both Grundfos MS and MMS submersible motors. When the temperature becomes too high, the protection device will cut out so damage to the pump and motor can be avoided.

Restart of the motor after cut-out can be achieved in two ways:

- manual restart
- automatic restart.

Automatic restart means that the MP 204 attempts to restart the motor after 15 minutes. If the first attempt is not successful, restarting will be reattempted at 30-minute intervals.

MS: The Grundfos MS submersible motors (with the exception of MS 402) are available with a built-in Tempcon temperature transmitter for protection against overtemperature. By means of the transmitter, it is possible to read out and/or monitor the motor temperature via an MP 204 or a PR 5714 relay.

The Grundfos MS 6000C submersible motors can be fitted with a Pt100. The Pt100 is fitted in the motor and connected directly to the MP 204 or monitored by the PR 5714 relay.

MMS: For the protection of the Grundfos MMS submersible motors against overtemperature, Grundfos offers the Pt100 temperature sensor as an optional extra.

The Pt100 is fitted in the motor and connected directly to the MP 204 or monitored by the PR 5714 relay.

Protection against upthrust

In case of a very low counter pressure in connection with start-up, there is a risk that the entire chamber stack may rise. This is called upthrust. Upthrust may damage both pump and motor. Grundfos pumps and motors are protected against upthrust as standard, preventing upthrust from occurring during the critical start-up phase. The protection consists of either a built-in stop ring or hydraulic balancing.

Built-in cooling chambers

In all Grundfos MS submersible motors, efficient cooling is ensured by cooling chambers at the top and at the bottom of the motor, and by an internal circulation of motor liquid. See fig. 10.

As long as the required flow velocity past the motor is maintained, cooling of the motor will be efficient.

Lightning protection

The smallest Grundfos submersible motors, such as the MS 402, are all insulated in order to minimize the risk of motor burnout caused by lightning strike.

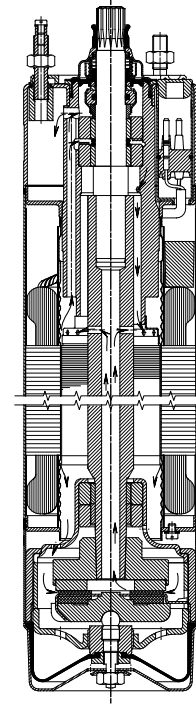

TM00 5698 0996

Fig. 10 MS 4000

Reduced risk of short-circuit

The embedded stator winding in the Grundfos MS submersible motor is hermetically enclosed in stainless steel. The result is high mechanical stability and optimum cooling. Also, this eliminates the risk of short-circuit of the windings caused by water condensation.

Shaft seal

MS 402

The shaft seal is of the lip seal type characterized by low friction against the rotor shaft.

The rubber material offers good wear resistance, good elasticity and resistance to particles, and it is approved for use in drinking water.

MS 4000

Ceramic/tungsten carbide materials provide the MS shaft seals with optimum sealing, optimum wear resistance and long life.

MS 6000C

The MS 6000C shaft seal material is SiC/SiC. The spring loaded shaft seal is designed with a large surface and a sand shield. The result is a minimum exchange of pumped and motor liquids and no penetration of particles.

Motors, version R, are supplied with a SiC/SiC shaft seal. Other combinations are available request. See fig. 11 and fig. 12 for an illustration of shaft seal components and configuration.

MMS rewindable motors

The standard shaft seal is a SiC/SiC mechanical shaft seal. The shaft seal is replaceable.

The material features good wear resistance and resistance to particles.

Together with the shaft seal housing, the sand shield forms a labyrinth seal, which during normal operating conditions prevents penetration of sand particles into the shaft seal.

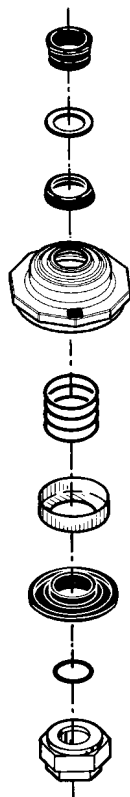

Fig. 11 Shaft seal, MS 4000

TM00 7306 0412

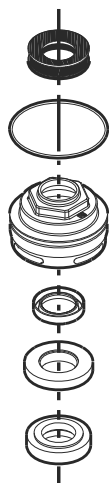

Fig. 12 Shaft seal, MS 6000C

TM03 9225 3607

Identification

Type key, SP pumps

Example	475	S	500 -	5 -	A	B
Rated flow rate in gpm						
Type range						
Stainless steel parts of material						
S = AISI 304						
N = AISI 316						
R = AISI 904L						
Hp of motor						
Number of impellers						
First reduced-diameter impeller (A, B or C)						
Second reduced-diameter impeller (A, B or C)						

Type key, MS 402 motors

Example	MS	4	02
Motor submersible			
Min. well casing diameter in inches			
Generation			
= Stainless steel AISI 304			

Type key, MS 4000 motors

Example	MS	4	000	R
Motor submersible				
Min. well casing diameter in inches				
Generation				
= Stainless steel AISI 304				
R = Stainless steel AISI 904L				
I = Stainless steel AISI 304 + De-rated				
RE = Stainless steel AISI 904L + FKM				
EI = Stainless steel AISI 304 + De-rated + FKM				

MS 6000C

Example pump: MS 6000CQFT40 3 x 460/60 25 Hp

Description	MS 6000C	Q	F	T40	3 x 25 460/60 Hp
Motor type					
Material type					
	= AISI 304 Stainless Steel (EN 1.4301)				
R	= AISI 904L stainless steel (EN 1.4539)				
Rubber					
	= NBR				
E	= FKM				
Shaft seal					
	= Ceramic/carbon BXPFF/NBR				
S	= SiC/SiC Q1Q1VFF/FKM				
Q	= SiC/SiC Q1Q1PFF/NBR				
Radial bearings					
	= Ceramic/hard metal				
W	= SiC/Tungsten carbide				
Motor liquid					
	= SML-3				
D	= Demineralized water				
H	= Glycol 60 vol % HTF				
Flange extension					
	= Without				
F	= With				
Tempcon					
	= With				
X	= Without				
Max. liquid temperature					
T40	= 104 °F (40 °C)				
T60	= 140 °F (60 °C)				
Voltage					
35	3 x 460/60 = 3 x 440-460-480 V, 60 Hz				
30	3 x 208-230/60 = 3 x 208-220-230 V, 60 Hz				
39	3 x 575/60 = 3 x 575 V, 60 Hz				
Method of starting					
	= DOL				
SD	= SD				
Motor power					
7.5 Hp	5.5 kW				
10 Hp	7.5 kW				
15 Hp	11 kW				
20 Hp	15 kW				
25 Hp	18.5 kW				
30 Hp	22 kW				
40 Hp	30 kW				

Type key, MMS motors

Example	MMS	6	000	N
Type range				
Min. well casing diameter in inches				
Generation				
Material:				
	= Cast iron EN-JL1040			
N	= DIN/EN 1.4401 (AISI 316)			

2. Product overview

Performance range 60 Hz

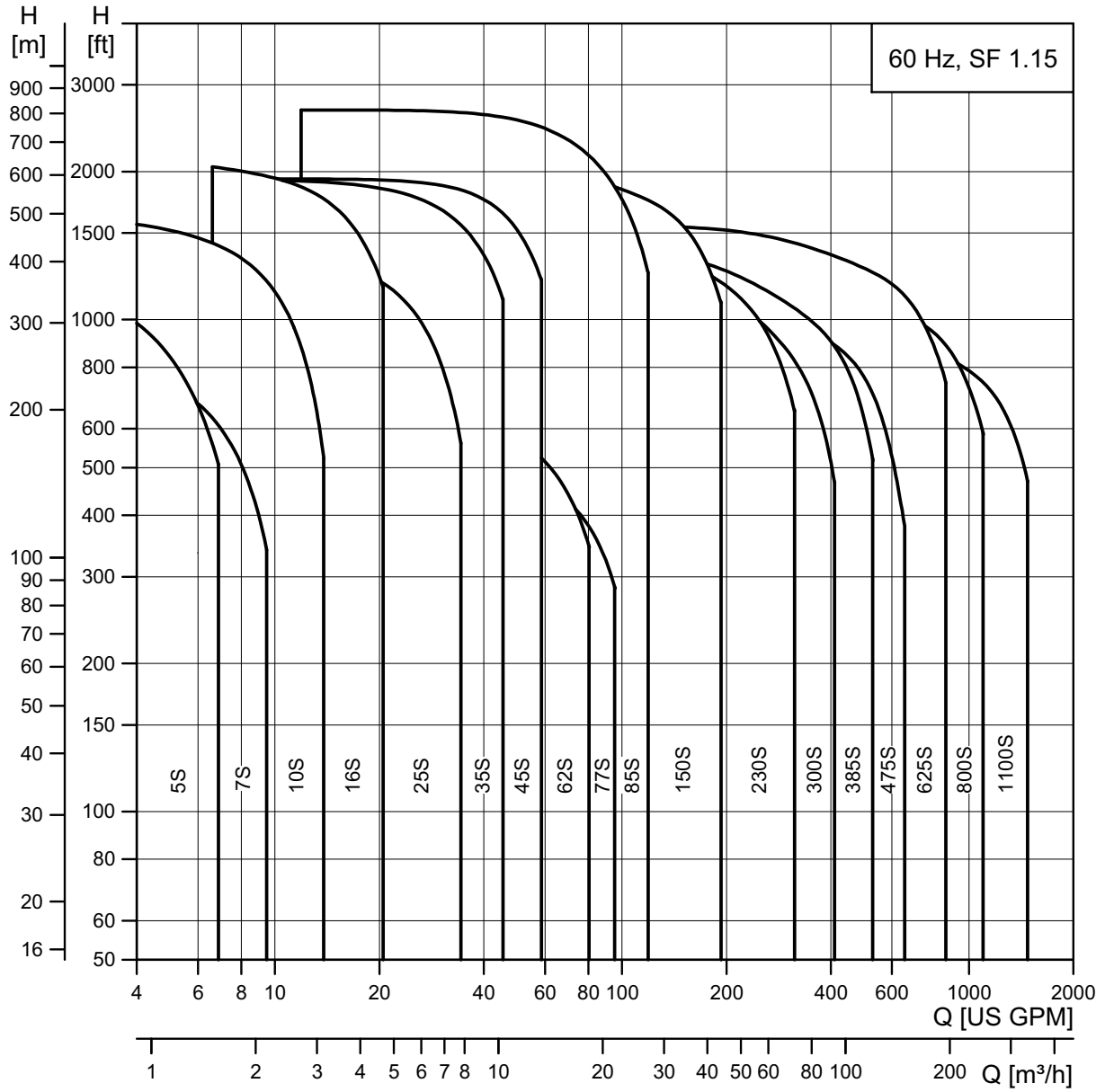

Pump range

Type		5S	10S	16S	25S	35S	45S	62S	77S	85S	150S	230S	300S	385S	475S	625S	800S	1100S
AISI 304 stainless steel		•	•	•	•	•	•	•	•	•	•	•	•	•	•	•	•	•
AISI 316 stainless steel				•	•	•	•	•	•	•	•	•	•	•	•	•	•	•
AISI 904L stainless steel					•					•	•	•	•	•	•	•	•	•
Connection ★	NPT	1"	1.25"	1.25"	1.5"	1.5" (2")	2" (2")	2"	2"	(3")	(3")	3" (4")	3" (4")	5"	5"	6"	6"	6"
Flange connection: Grundfos flange														5"	5"	6"	6"	6"

★ Figures in brackets () indicate connection for pumps with sleeve.

Motor range

Motor output [Hp]	0.5	0.75	1.0	1.5	1.5	3.0	5.0	7.5	10.0	15	20	25	30	40	50	60	75	100	125	150	175	200	250	
Single-phase	•	•	•	•	•	•																		
Three-phase	•	•	•	•	•	•	•	•	•	•	•	•	•	•	•	•	•	•	•	•	•	•	•	•
Industrial motor						•	•	•	•	•	•	•	•											
Rewindable motor							•	•	•	•	•	•	•	•	•	•	•	•	•	•	•	•	•	•
Steel: AISI 304	•	•	•	•	•	•	•	•	•	•	•	•	•	•										
Steel: AISI 304 and cast iron							•	•	•	•	•	•	•	•	•	•	•	•	•	•	•	•	•	•
Steel: AISI 316							•	•	•	•	•	•	•	•	•	•	•	•	•	•	•	•	•	•
Steel: AISI 904L			•	•	•	•	•	•	•	•	•	•	•	•	•	•	•	•	•	•	•	•	•	•
Built-in temperature transmitter in motor		•	•	•	•	•	•	•	•	•	•	•	•	•										

Direct-on-line starting is recommended up to 100 Hp.

Soft starter or autotransformer is recommended above 100 Hp.

Motors with star/delta are available from 7.5 Hp.

Motor protection and controllers

Motor output [Hp]	0.5	0.75	1.0	1.5	1.5	3.0	5.0	7.5	10.0	15	20	25	30	40	50	60	75	100	125	150	175	200	250	
MP 204	•	•	•	•	•	•	•	•	•	•	•	•	•	•	•	•	•	•	•	•	•	•	•	•
Pt100							•	•	•	•	•	•	•	•	•	•	•	•	•	•	•	•	•	•
Zinc anode				•	•	•	•	•	•	•	•	•	•	•	•	•	•	•	•	•	•	•	•	•
Vertical flow sleeve	•	•	•	•	•	•	•	•	•	•	•	•	•	•	•	•	•	•	•	•	•	•	•	•
Horizontal flow sleeve	•	•	•	•	•	•		•	•	•	•	•	•	•										
SA-SPM	•	•	•	•	•	•	•																	
GO remote	•	•	•	•	•	•	•	•	•	•	•	•	•	•	•	•	•	•	•	•	•	•	•	•
RS-485 communication module	•	•	•	•	•	•	•	•	•	•	•	•	•	•	•	•	•	•	•	•	•	•	•	•
G100	•	•	•	•	•	•	•	•	•	•	•	•	•	•	•	•	•	•	•	•	•	•	•	•

Motor protection of single-phase motors, see page 98.

3. Construction

Sectional drawing, SP pump 4" spline shaft (SP 5S - 25S)

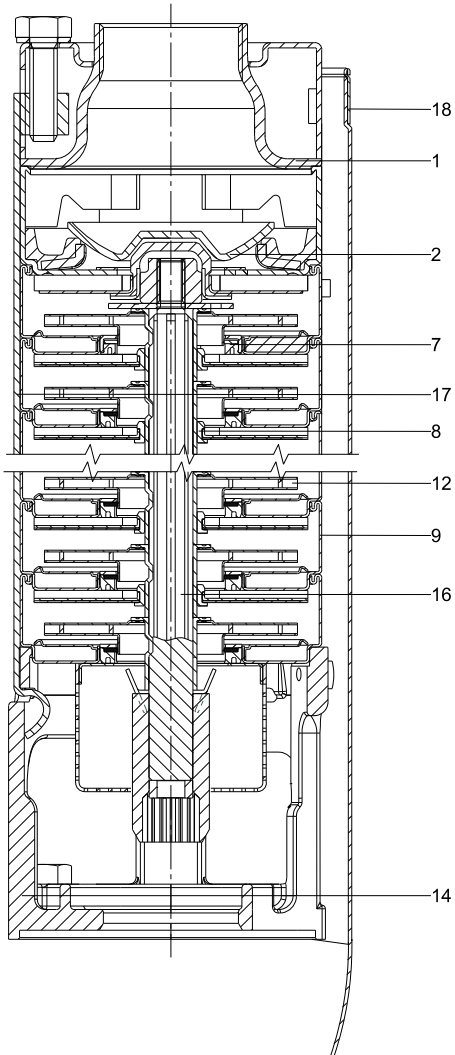

TM06 93 1614

Fig. 13 SP pump, 4" spline shaft (SP 5S - 25S)

Material specification

Pos.	Component	Material	Standard N-version R-version		
			[AISI (EN)]		
1	Valve casing	Stainless steel	304 (1.4301)	316 (1.4401)	904L (1.4539)
2	Valve cup	Stainless steel	304 (1.4301)	316 (1.4401)	904L (1.4539)
7	Neck ring	NBR/TPU			
8	Bearing	NBR			
9	Chamber	Stainless steel	304 (1.4301)	316 (1.4401)	904L (1.4539)
12	Impeller	Stainless steel	304 (1.4301)	316 (1.4401)	904L (1.4539)
14	Suction interconnector	Cast stainless steel	304 (1.4308)	316 (1.4408)	904L (1.4517)
16	Shaft complete	Stainless steel	431 (1.4057)	329 (1.4460)	904L (1.4462)
17	Strap	Stainless steel	304 (1.4301)	316 (1.4401)	904L (1.4539)
18	Cable guard	Stainless steel	304 (1.4301)	316 (1.4401)	904L (1.4539)
	Washer for stop ring	Carbon/graphite HY22 in PTFE mass			
	Strainer	Stainless steel	304 (1.4301)	316 (1.4401)	904L (1.4539)
	Valve seat	Rubber type	NBR	NBR-FKM	NBR-FKM

Sectional drawing, SP pump 4" smooth shaft (SP 35S - 77S)

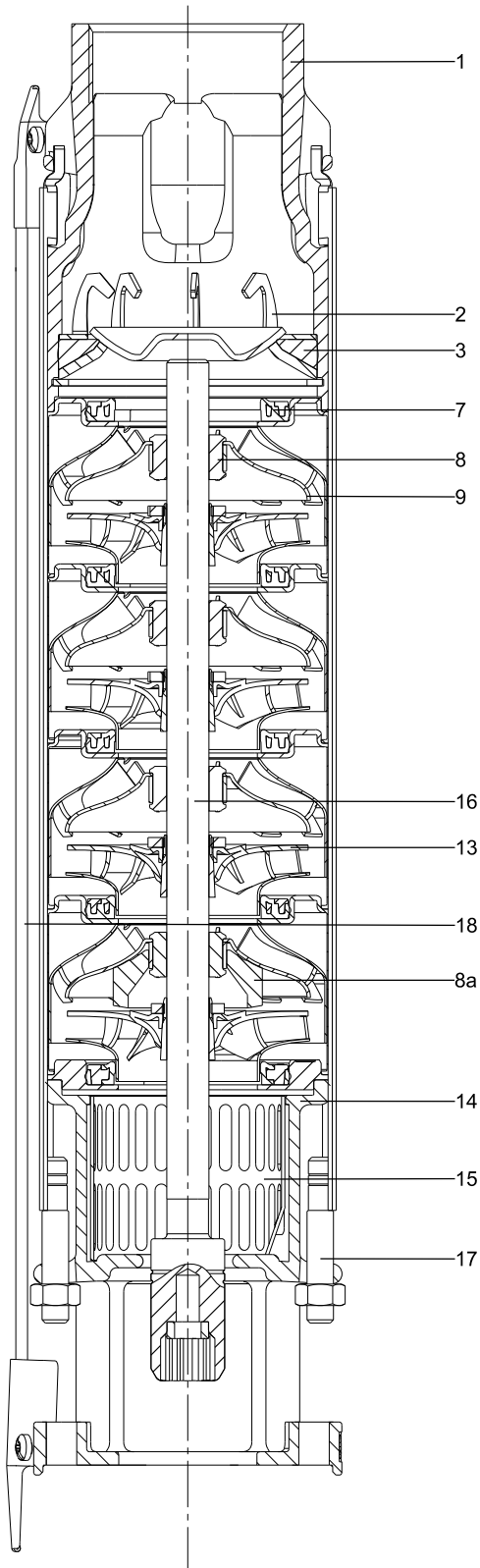

Fig. 14 SP pump, 4" smooth shaft (SP 35S - 77S)

TM06 1110 1614

Material specification

Pos.	Component	Material	Standard N-version R-version		
			[AISI (EN)]		
1	Valve casing	Cast stainless steel	304 (1.4301)	316 (1.4401)	904L (1.4539)
2	Valve cup	Cast stainless steel	304 (1.4301)	316 (1.4401)	904L (1.4539)
3	Valve seat	NBR-FKM	NBR-FKM	NBR-FKM	NBR-FKM
7	Neck ring	TPU/PPS-FKM	TPU/ PPS-FKM	TPU/ PPS-FKM	TPU/ PPS-FKM
8	Bearing	LSR-FKM	LSR/FKM	LSR/FKM	LSR/FKM
8a	Washer for stop ring	Carbon/graphite HY22 in PTFE mass			
9	Chamber	Stainless steel	304 (1.4301)	316 (1.4401)	904L (1.4539)
13	Impeller	Stainless steel	304 (1.4301)	316 (1.4401)	904L (1.4539)
14	Suction interconnector	Cast stainless steel	304 (1.4308)	316 (1.4408)	904L (1.4517)
16	Shaft complete	Stainless steel	1.4057	1.4460	1.4462
17	Strap	Stainless steel	304 (1.4301)	316 (1.4401)	904L (1.4539)
18	Cable guard	Stainless steel	304 (1.4301)	316 (1.4401)	904L (1.4539)
	Strainer	Stainless steel	304 (1.4301)	316 (1.4401)	904L (1.4539)

Sectional drawing, SP pump 6" (SP 85S - 300S)

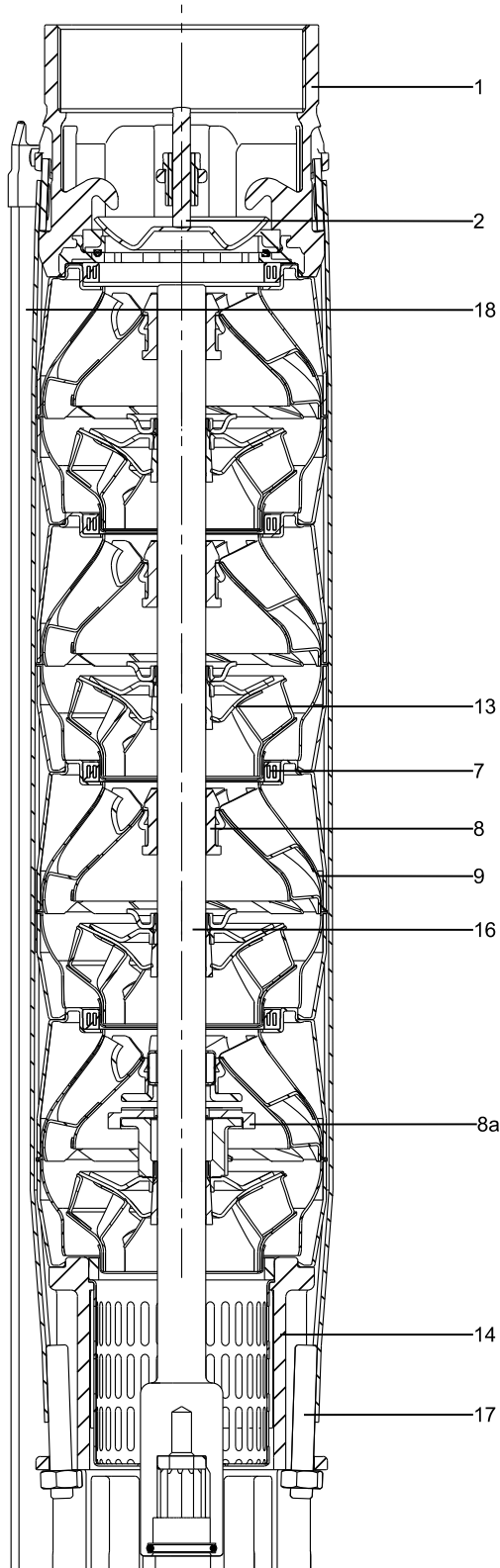

Fig. 15 Example, 6" (SP 85S - 300S)

TM06 1521 1614

Material specification

Pos.	Component	Material	Standard	N-version	R-version
			[AISI (EN)]		
1	Valve casing	Stainless steel	304 (1.4301)	316 (1.4401)	904L (1.4539)
2	Valve cup	Stainless steel	304 (1.4301)	316 (1.4401)	904L (1.4539)
	Valve seat	NBR-FKM	NBR-FKM	NBR-FKM	NBR-FKM
7	Neck ring	NBR-FKM	NBR-FKM	NBR-FKM	NBR-FKM
8	Bearing	NBR-FKM-LSR	NBR-FKM-LSR	NBR-FKM-LSR	NBR-FKM-LSR
	Washer for stop ring	Carbon/graphite HY22 in PTFE mass			
9	Chamber	Stainless steel	304 (1.4301)	316 (1.4401)	904L (1.4539)
13	Impeller	Stainless steel	304 (1.4301)	316 (1.4401)	904L (1.4539)
14	Suction interconnector	Cast stainless steel	304 (1.4308)	316 (1.4408)	904L (1.4517)
	Strainer	Stainless steel	304 (1.4301)	316 (1.4401)	904L (1.4539)
16	Shaft complete	Stainless steel	431 (1.4057)	329 (1.4460)	904L (1.4462)
17	Strap	Stainless steel	304 (1.4301)	316 (1.4401)	904L (1.4539)
18	Cable guard	Stainless steel	304 (1.4301)	316 (1.4401)	904L (1.4539)

Sectional drawing, SP pump 8" (SP 385S - 475S)

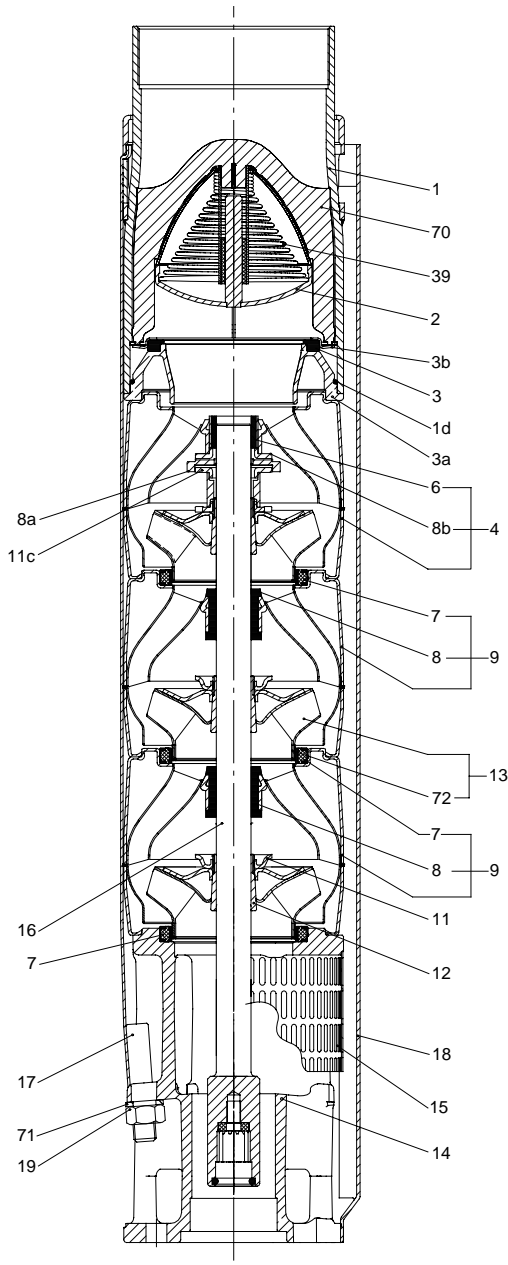

TM01 23359 2301

Fig. 16 SP pump, 8" (SP 385S - 475S)

Material specification

Pos.	Component	Materials	Standard	N	R
			[AISI (EN)]		
1	Valve casing	Stainless steel	304 (1.4301)	316 (1.4401)	904L (1.4539)
1d	O-ring	NBR			
2	Valve cup	Stainless steel	304 (1.4301)	316 (1.4401)	904L (1.4539)
3	Valve seat	Standard/ N- version: NBR R-version: FKM			
3a	Lower valve seat retainer	Stainless steel	316 (1.4401)	316 (1.4401)	904L (1.4517)
3b	Upper valve seat retainer	Stainless steel	304 (1.4301)	316 (1.4401)	904L (1.4539)
4	Top chamber	Stainless steel	304 (1.4301)	316 (1.4401)	904L (1.4539)
6	Upper bearing	Stainless steel/NBR	304 (1.4301)	316 (1.4401)	904L (1.4539)
7	Neck ring	NBR/PPS			
8	Bearing	NBR			
8a	Washer for stop ring	Carbon/ graphite HY22 in PTFE mass			
8b	Stop ring	Stainless steel	316 (1.4401)	316 (1.4401)	904L (1.4539)
9	Chamber	Stainless steel	304 (1.4301)	316 (1.4401)	904L (1.4539)
11	Split cone nut	Stainless steel	304 (1.4301)	316 (1.4401)	904L (1.4539)
11c	Nut for stop ring	Stainless steel	316 (1.4401)	316 (1.4401)	904L (1.4539)
12	Split cone	Stainless steel	304 (1.4301)	316 (1.4401)	904L (1.4539)
13	Impeller	Stainless steel	304 (1.4301)	316 (1.4401)	904L (1.4539)
14	Suction interconnector	Stainless steel	CF8M	A744 CD4-MCu	904L (1.4517)
15	Strainer	Stainless steel	304 (1.4301)	316 (1.4401)	904L (1.4539)
16	Shaft complete	Stainless steel	431 (1.4057)	329 (1.4460)	329 (1.4460)
17	Strap	Stainless steel	304 (1.4301)	316 (1.4401)	904L (1.4539)
18	Cable guard	Stainless steel	304 (1.4301)	316 (1.4401)	904L (1.4539)
19	Nut for strap	Stainless steel	304 (1.4301)	316 (1.4401)	904L (1.4539)
39	Spring for valve cup	Stainless steel	304 (1.4301)	316 (1.4401)	SAF 2205
70	Valve guide	Stainless steel	304 (1.4301)	316 (1.4401)	904L (1.4539)
71	Washer	Stainless steel	316 (1.4401)	316 (1.4401)	904L (1.4539)
72	Wear ring	Stainless steel	304 (1.4301)	316 (1.4401)	904L (1.4539)

Sectional drawing, SP pump 10" (SP 625S - 1100S)

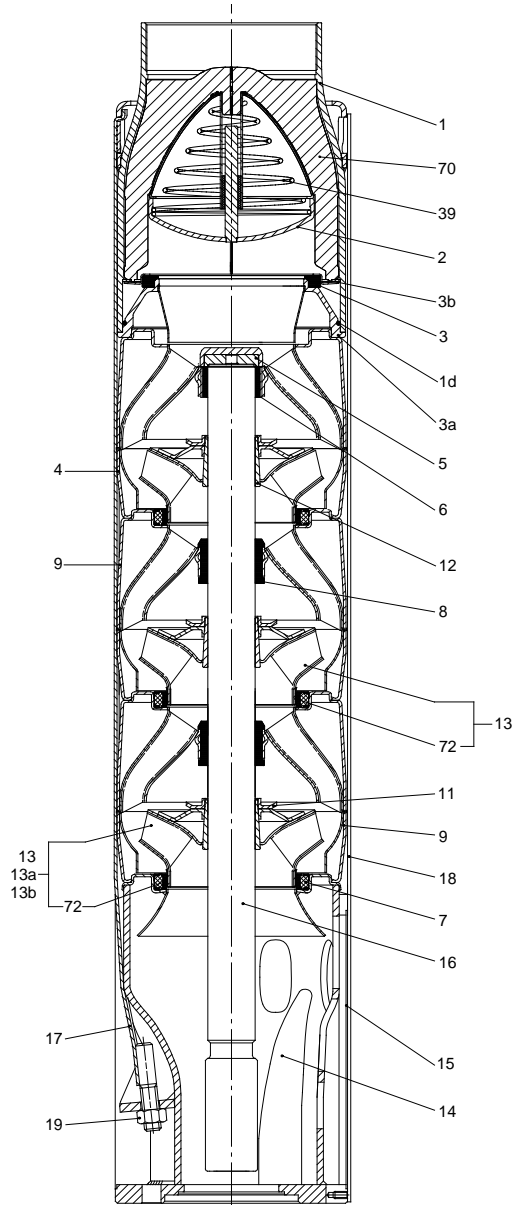

Fig. 17 SP pump, 10" (SP 625S - 1100S)

TM01 2363 2701

Material specification

Pos.	Description	Material	Standard	N
			[AISI (EN)]	
Valve casing				
1	Valve casing	Stainless steel	304 (1.4301)	316 (1.4401)
1d	O-ring	NBR		
2	Valve cup	Stainless steel	304 (1.4301)	316 (1.4401)
3	Valve seat	Stainless steel	304 (1.4301)	316 (1.4401)
3a	Lower valve seat retainer	Stainless steel	304 (1.4301)	316 (1.4401)
3b	Upper valve seat retainer	Stainless steel	304 (1.4301)	316 (1.4401)
39	Spring for valve cup	Stainless steel	301 (1.4310)	316 (1.4401)
70	Valve guide	Stainless steel	304 (1.4301)	316 (1.4401)
78	Nameplate	Stainless steel	304 (1.4301)	316 (1.4401)
79	Rivet	Stainless steel	304 (1.4301)	316 (1.4401)
63	Connecting piece	Stainless steel	304 (1.4301)	316 (1.4401)
Chamber stack				
4	Top chamber	Stainless steel	304 (1.4301)	316 (1.4401)
5	Uphrust disc	Carbon/ graphite HY22 in PTFE mass		
6	Top bearing	Stainless steel/ NBR	304 (1.4301)	316 (1.4401)
7	Neck ring	NBR/PPS		
8	Bearing	NBR		
9	Chamber	Stainless steel	304 (1.4301)	316 (1.4401)
11	Nut for split cone	Stainless steel	304 (1.4301)	316 (1.4401)
12	Split cone	Stainless steel	304 (1.4301)	316 (1.4401)
13	Impeller	Stainless steel	304 (1.4301)	316 (1.4401)
16	Shaft with coupling	Stainless steel	431 (1.4057)	329 (1.4460)
18	Cable guard	Stainless steel	304 (1.4301)	316 (1.4401)
18a, 18b	Screw for cable guard	Stainless steel	304 (1.4301)	316 (1.4401)
23	Rubber guard	NBR		
72	Wear ring	Stainless steel	304 (1.4301)	316 (1.4401)
Suction interconnector				
14	Suction interconnector	Stainless steel	304 (1.4301)	316 (1.4401)
15	Strainer	Stainless steel	304 (1.4301)	316 (1.4401)
17	Strap	Stainless steel	304 (1.4301)	316 (1.4401)
19	Nut for strap	Stainless steel	304 (1.4301)	316 (1.4401)
19a	Nut	Stainless steel	316 (1.4401)	316 (1.4401)
20	Motor cable			
22	Bolts	Stainless steel	316 (1.4401)	316 (1.4401)
28, 28a	Lock for strainer	Stainless steel	329 (1.4460)	329 (1.4460)

Sectional drawing, MS motors

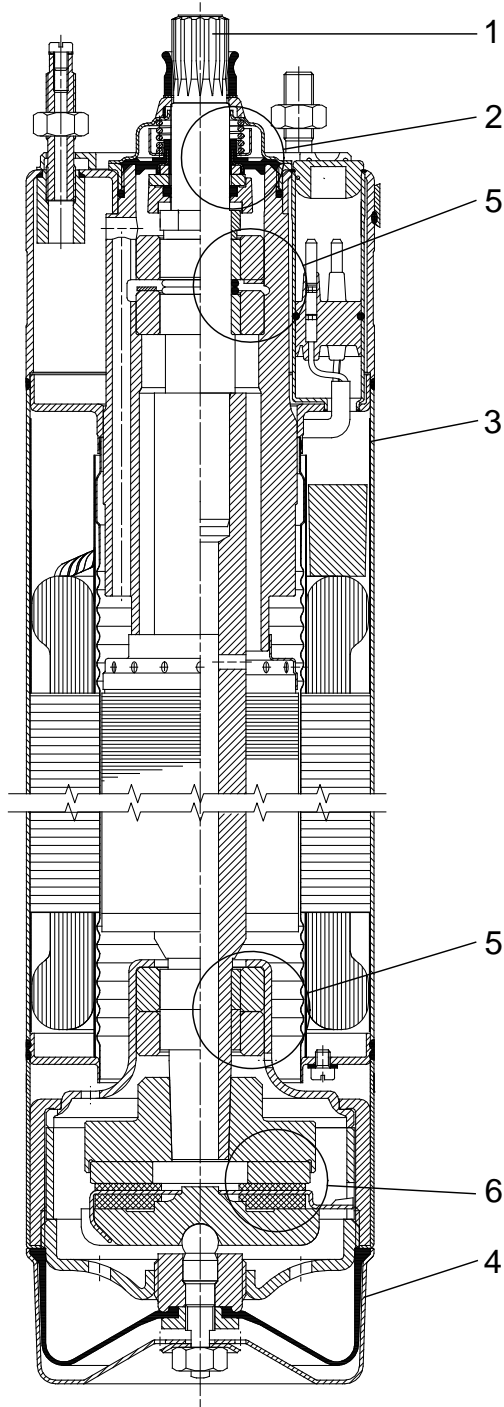

Fig. 18 MS 4000 motor

TM00 7865 2196

Material specification, MS 402, MS 4000, and MS 6000C motors

Pos.	Part	MS 402	MS 4000 MS 6000C
		[AISI (EN)]	
1	Shaft	431	431
2	Shaft seal	NBR	NBR/SiC/SiC
3	Motor sleeve	304 (1.4301)	304 (1.4301)
4	Motor end shield	304 (1.4301)	304 (1.4301)
5	Radial bearing	Ceramic	Ceramic/ tungsten carbide
6	Axial bearing	Ceramic/carbon	Ceramic/carbon
	Rubber parts	NBR	NBR

R-version motor

Pos.	Part	MS 4000 MS 6000C
1	Shaft	318 LN
2	Shaft seal	SiC/SiC
3	Motor sleeve	904L (1.4539)
4	Motor end shield	904L (1.4539)
5	Radial bearing	Ceramic/tungsten carbide
6	Thrust bearing	Ceramic/carbon
	Rubber parts	NBR

Sectional drawing, MMS motors

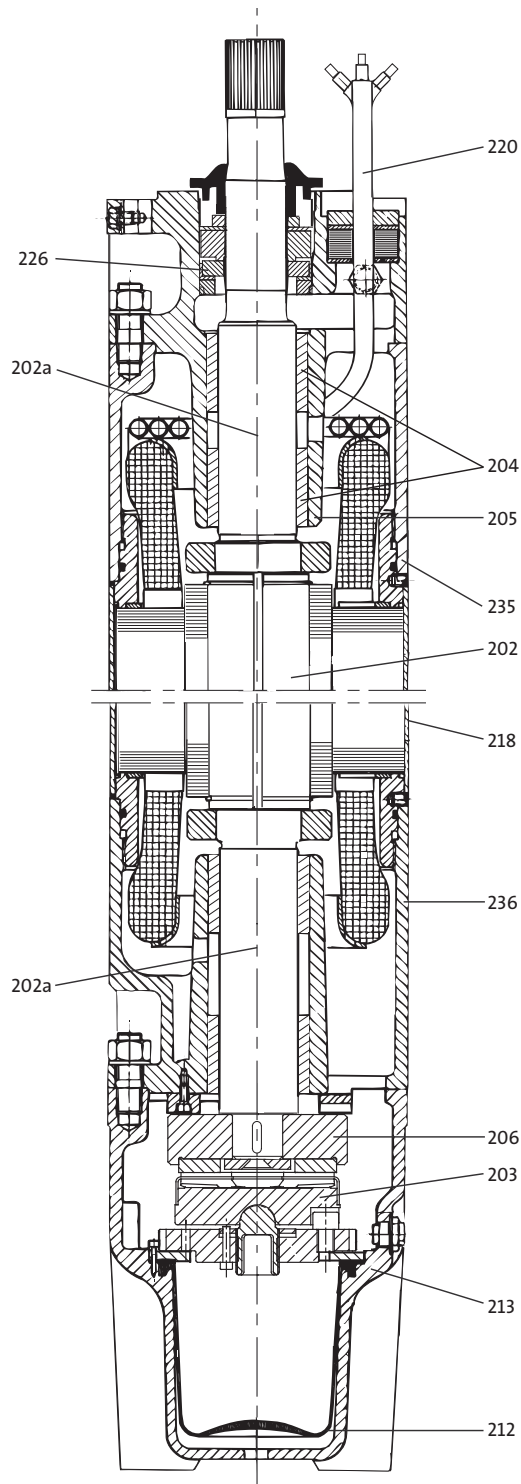

Fig. 19 MMS 10000

TM01 4985 0404

Material specification

MMS motors, submersible rewindable versions

Pos.	Component	Material	[AISI (EN)]
202	Shaft	Steel	(1.0533)
202a	Shaft ends	Stainless steel	316/329 (1.4401/1.4460)
203/2 06	Thrust bearing Stationary/ rotating part	6", 0.5 - 20 Hp	Hardened steel/EPDM
		6", 25-50 Hp	Ceramic/ carbon
		8" - 10"	
204	Bearing bush	6" - 10"	Carbon
205	Bearing housing, upper		Cast iron A126 Class B
212	Diaphragm		CR
213	Motor end shield		Cast iron A126 Class B
218	Motor sleeve		Stainless steel 304 (1.4301)
220	Motor cable		EPDM
226	Shaft seal		SiC/SiC
235	Intermediate housing		Cast iron A126 Class B
236	Bearing housing, lower		Cast iron A126 Class B

MMS motors, N and R versions

Pos.	Component	Material	Version	
			N	R*
[AISI (EN)]				
202	Shaft	Steel	(1.0533)	
202a	Shaft ends	Stainless steel	316/329 (1.4401/1.4460)	318LN (1.4462)
203/2 06	Thrust bearing Stationary/ rotating part	6", 0.5 - 20 Hp	Hardened steel/EPDM	
		6", 25-50 Hp	Ceramic/ carbon	
		8" - 10"		
204	Bearing bush	6" - 10"	Carbon	
205	Bearing housing, upper	Stainless steel	316 (1.4401)	904L (1.4539)
212	Diaphragm		CR	
213	Motor end shield	Stainless steel	316 (1.4401)	904L (1.4539)
218	Motor sleeve	Stainless steel	316 (1.4401)	904L (1.4539)
220	Motor cable		EPDM	
226	Shaft seal		SiC/SiC	
235	Intermediate housing	Stainless steel	316 (1.4401)	904L (1.4539)
236	Bearing housing, lower	Stainless steel	316 (1.4401)	904L (1.4539)

* Only MMS 6 and MMS 8000 are available in R versions

4. Operating conditions

Operating conditions

Flow rate, Q: 0.44 - 1475 gpm (0.1 - 335 m³/h).
Head, H: Maximum 2657 ft (810 m).

Maximum liquid temperature

Motor	Installation		
	Flow velocity past motor	Vertical [°F (°C)]	Horizontal [°F (°C)]
Grundfos MS 4" and MS 6000C T-40 versions	0.49 fps (0.15 m/s)	104 (40)	104 (40)
Grundfos 4" MS industry versions	0.49 fps (0.15 m/s)	140 (60)	140 (60)
Grundfos MS 6000C T60-versions	3.28 fps (1.0 m/s)	140 (60)	140 (60)
Grundfos MMS 6" to 12" rewindable with PVC in the windings	0.49 fps (0.15 m/s)	77 (25)	77 (25)
	1.64 fps (0.50 m/s)	86 (30)	86 (30)
Grundfos MMS 6" to 12" rewindable with PE/PA in the windings	0.49 fps (0.15 m/s)	104 (40)	104 (40)
	1.64 fps (0.50 m/s)	113 (45)	113 (45)

Note: For MMS 6, 50 Hp; MMS 8000, 150 Hp; the maximum liquid temperature is 9 °F (5 °C) lower than the values stated in the table. For MMS 10000, 250 Hp, the temperature is 18 °F (10 °C) lower.

Operating pressure

Motor	Maximum operating pressure
Grundfos MS 4" and 6"	870 psi (6 Mpa) (60 bar)
Grundfos MMS 6" to 10" rewindable	

Curve conditions

The conditions below apply to the curves shown on pages 21-93:

General

- Curve tolerances according to ISO 9906, Annex A.
- The performance curves show pump performance at actual speed, cf. standard motor range.
The speeds of the motors are approximately these:
4" motors: n = 3470 rpm
6" motors: n = 3460 rpm
8" motors: n = 3480 rpm
10" motors: n = 3520 rpm
- The measurements were made with airless water at a temperature of 68 °F (20 °C). The curves apply to a kinematic viscosity of 1 mm²/s (1 cSt). When pumping liquids with a density higher than that of water, use motors with correspondingly higher outputs.
- The **bold** curves indicate the recommended performance range.
- The performance curves are inclusive of possible losses such as check valve loss.
- **Q/H:** The curves are inclusive of valve and inlet losses at the actual speed.
Operation without check valve will increase the actual head at rated performance by 1.6 ft to 3.3 ft (0.5 m to 1.0 m).
- **NPSH:** The curve is inclusive of pressure loss in the suction interconnector and shows required inlet pressure.
- **Power curve:** P₂ shows pump power input [Hp] at the actual speed of each individual pump size.
- **Efficiency curve:** Eta shows pump stage efficiency. If Eta for the actual pump size is needed, please consult Grundfos Product Center.

5. How to read the curve charts

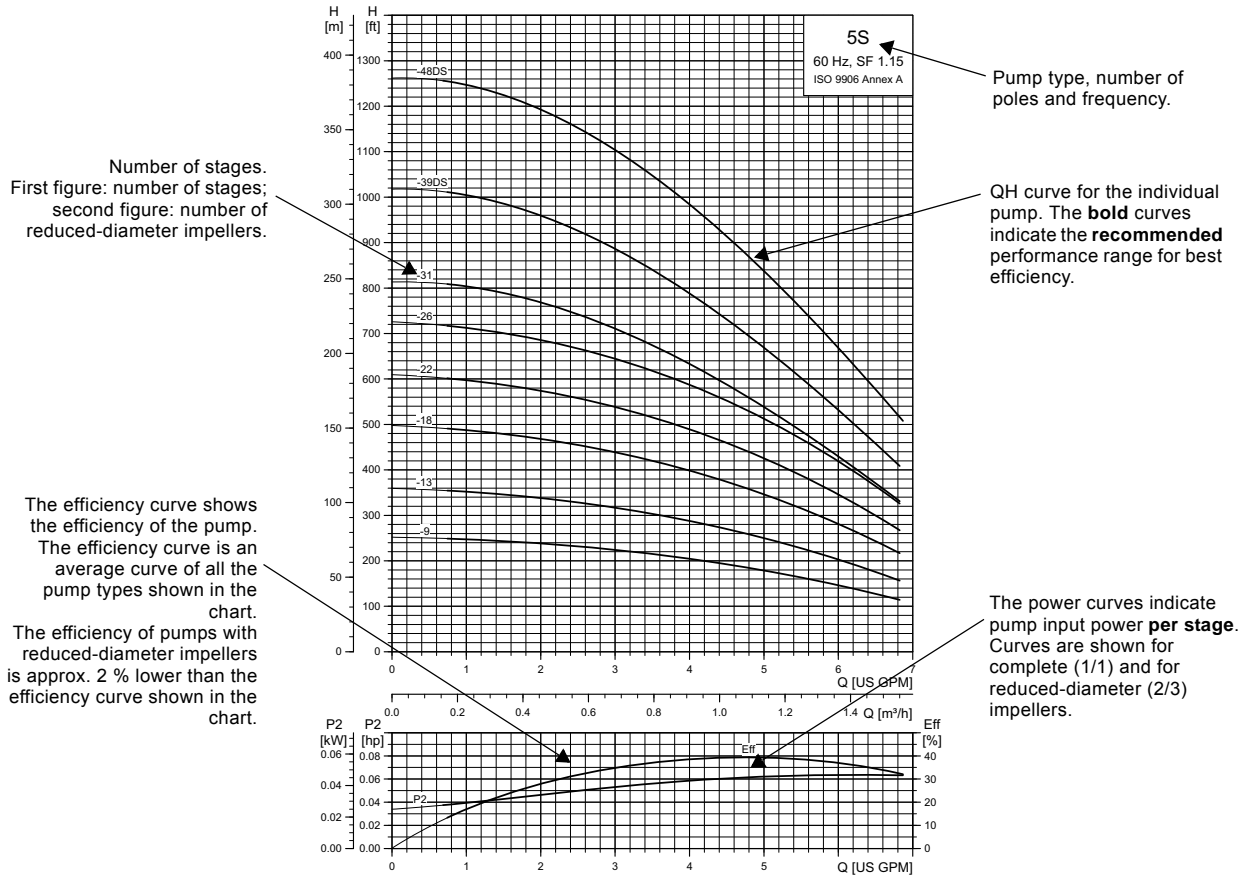

6. Curve charts and technical data

4" and larger wells

SP 5S (5 gpm)

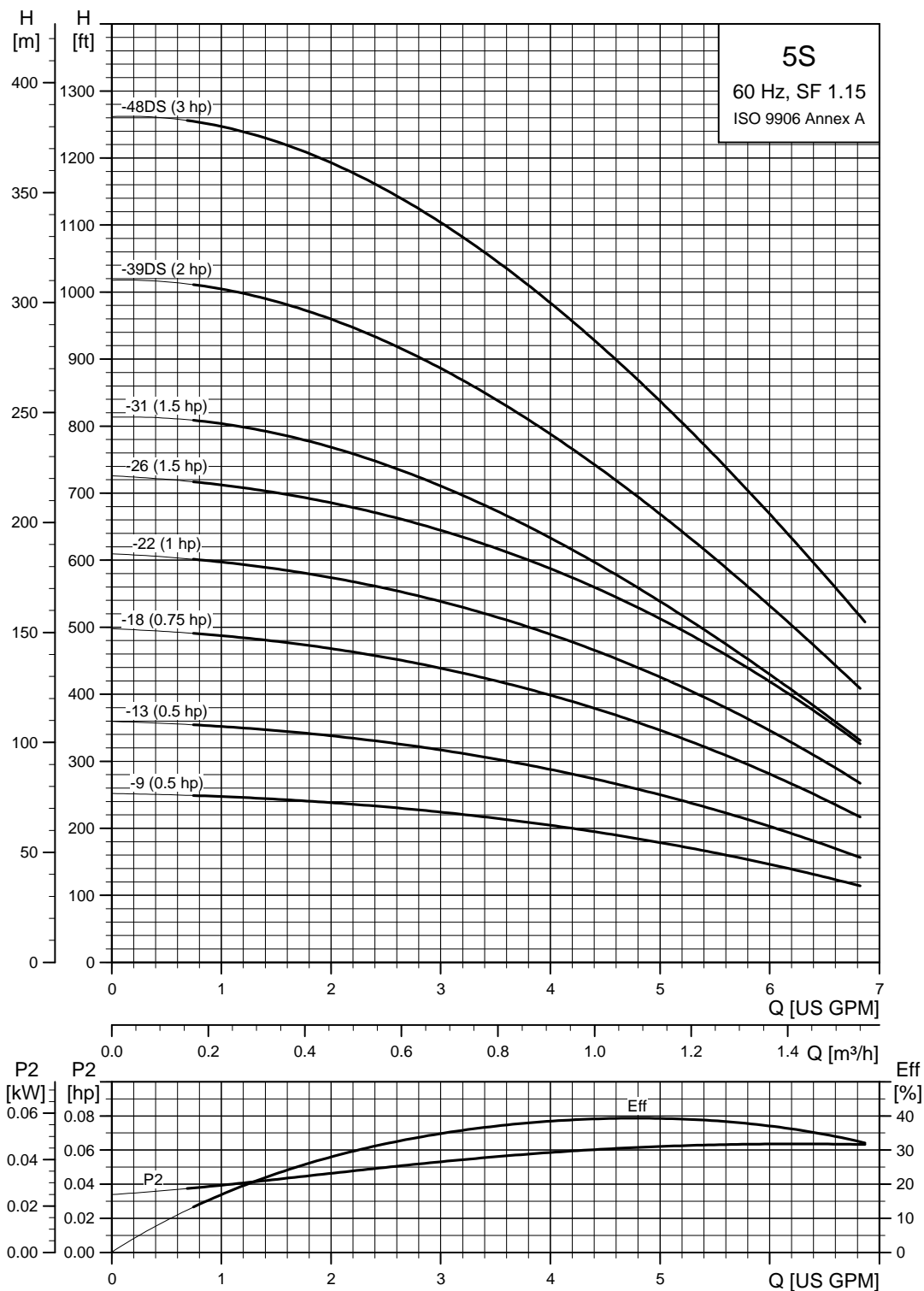

TMO5 0229 2112

4" and larger wells - continued

SP 5S (5 gpm) / 4 inch motor

Pump model	Nom. head [ft]	Ph	Volts [V]	Motor [Hp]	Dimensions					Net weight (complete) [lb]
					A [in. (mm)]	B [in. (mm)]	C [in. (mm)]	D [in. (mm)]	E [in. (mm)]	
5S, motor dia. 4 inch, 2 wire motor, 60 Hz - rated flow 5 gpm (1" NPT)										
5S05-9	171	1	230	0.5	■ 24.57 (624)	11.03 (280)	13.55 (344)	3.74 (95)	3.98 (101)	21.6
5S05-13	247	1	115	0.5	■ 27.88 (708)	11.03 (280)	16.86 (428)	3.74 (95)	3.98 (101)	26.9
			230	0.5	■ 27.88 (708)	11.03 (280)	16.86 (428)	3.74 (95)	3.98 (101)	26.1
5S07-18	343	1	230	0.75	■ 32.60 (828)	11.62 (295)	20.99 (533)	3.74 (95)	3.98 (101)	29.7
5S10-22	419	1	230	1	■ 36.50 (927)	12.21 (310)	24.30 (617)	3.74 (95)	3.98 (101)	32.4
5S15-26	495	1	230	1.5	■ 41.30 (1049)	13.71 (348)	27.60 (701)	3.74 (95)	3.98 (101)	41.4
5S15-31	527	1	230	1.5	■ 47.21 (1199)	13.71 (348)	33.51 (851)	3.74 (95)	3.98 (101)	47.7
5S, motor dia. 4 inch, 3 wire motor, 60 Hz - rated flow 5 gpm (1" NPT)										
5S05-9	171	1	230	0.5	■ 24.57 (624)	11.03 (280)	13.55 (344)	3.74 (95)	3.98 (101)	22.5
5S05-13	247	1	115	0.5	■ 27.88 (708)	11.03 (280)	16.86 (428)	3.74 (95)	3.98 (101)	26.9
			230	0.5	■ 27.88 (708)	11.03 (280)	16.86 (428)	3.74 (95)	3.98 (101)	25.2
5S07-18	343	1	230	0.75	■ 32.60 (828)	11.62 (295)	20.99 (533)	3.74 (95)	3.98 (101)	28.8
5S10-22	419	1	230	1	■ 36.50 (927)	12.21 (310)	24.30 (617)	3.74 (95)	3.98 (101)	32.4
			230	1.5	■ 41.30 (1049)	13.71 (348)	27.60 (701)	3.74 (95)	3.98 (101)	37.8
5S15-26	495	3	230	1.5	■ 39.81 (1011)	12.21 (310)	27.60 (701)	3.74 (95)	3.98 (101)	38.7
			460	1.5	■ 39.81 (1011)	12.21 (310)	27.60 (701)	3.74 (95)	3.98 (101)	38.7
			1	230	1.5	■ 47.21 (1199)	13.71 (348)	33.51 (851)	3.74 (95)	3.98 (101)
5S15-31	527	3	230	1.5	■ 45.71 (1161)	12.21 (310)	33.51 (851)	3.74 (95)	3.98 (101)	45.0
			460	1.5	■ 45.71 (1161)	12.21 (310)	33.51 (851)	3.74 (95)	3.98 (101)	45.0
			1	230	2	● 59.61 (1514)	19.49 (495)	40.12 (1019)	3.74 (95)	4.25 (108)
5S20-39DS	663	3	230	2	■ 53.82 (1367)	13.71 (348)	40.12 (1019)	3.74 (95)	4.25 (108)	54.0
			460	2	■ 53.82 (1367)	13.71 (348)	40.12 (1019)	3.74 (95)	4.25 (108)	54.0
			1	230	3	● 70.16 (1782)	22.60 (574)	47.56 (1208)	3.74 (95)	4.25 (108)
5S30-48DS	816	3	230	3	● 65.56 (1665)	18.00 (457)	47.56 (1208)	3.74 (95)	4.25 (108)	77.4
			460	3	● 65.56 (1665)	18.00 (457)	47.56 (1208)	3.74 (95)	4.25 (108)	77.4

Notes:

Control box is required for 3-wire, single-phase applications. Data does not include control box.

DS designation = Built into sleeve, 1 - 1/2" NPT, 6" minimum well diameter.

Performance conforms to ISO 9906: 1999 (E) Annex A. Minimum submergence is 2 feet.

- MS 402 motor.
- MS 4000 motor.

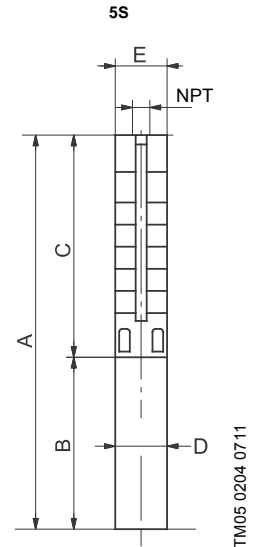

E = Maximum diameter of pump including cable guard and motor.

TM05 0204 0711

4" and larger wells - continued

SP 7S (7 gpm)

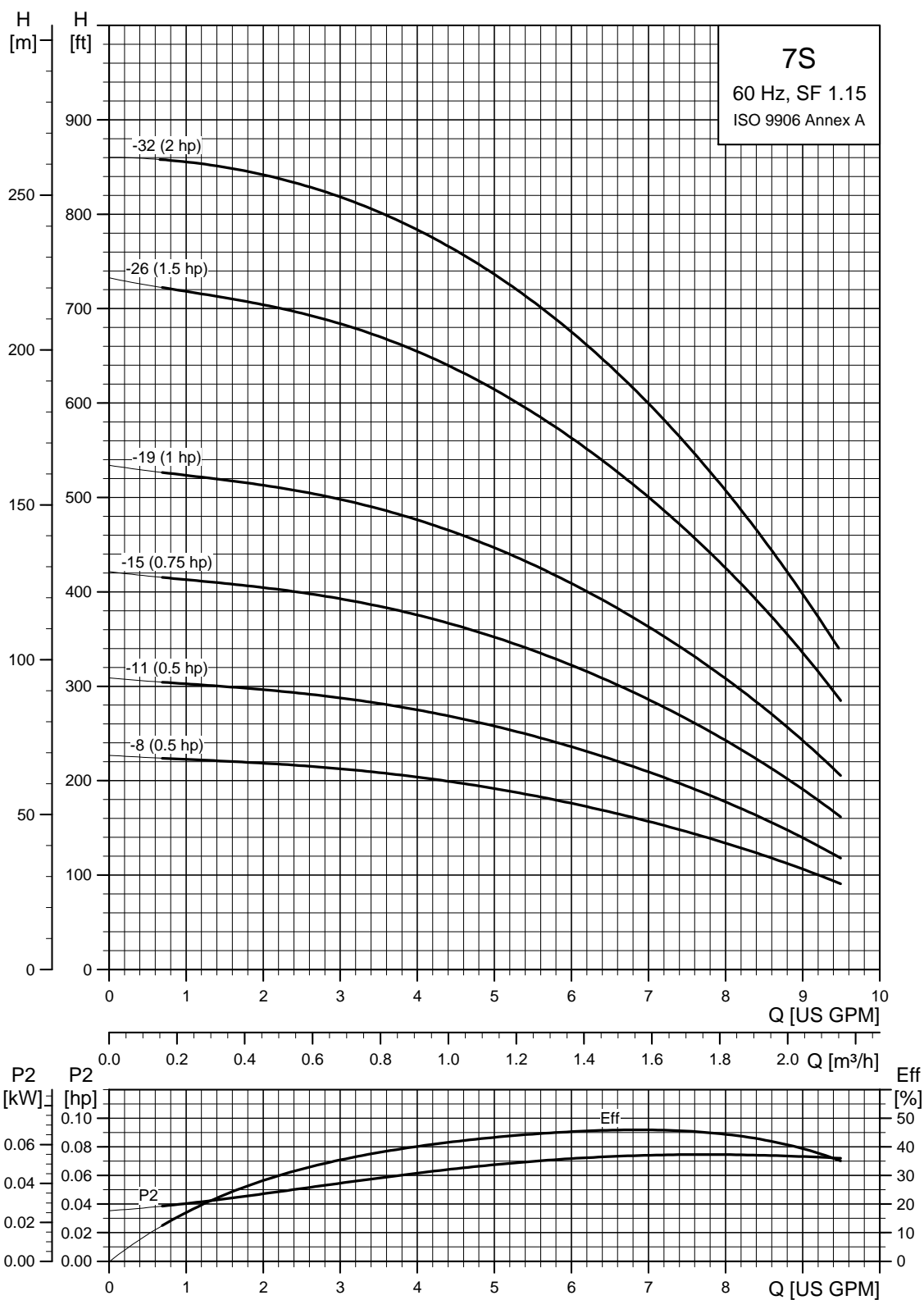

TM05 0982 2112

4" and larger wells - continued

SP 7S (7 gpm) / 4 inch motor

Pump model	Nom. head [ft]	Ph	Volts [V]	Motor [Hp]	Dimensions					Net weight (complete) [lb]	
					A [in. (mm)]	B [in. (mm)]	C [in. (mm)]	D [in. (mm)]	E [in. (mm)]		
7S, motor dia. 4 inch, 2 wire motor, 60 Hz - rated flow 7 gpm (1" NPT)											
7S05-8	151	1	230	.5 ■	23.75 (603)	11.03 (280)	12.72 (323)	3.74 (95)	3.98 (101)	21.6	
			115	.5 ■	26.23 (666)	11.03 (280)	15.20 (386)	3.74 (95)	3.98 (101)	29.7	
7S05-11	208	1	230	.5 ■	26.23 (666)	11.03 (280)	15.20 (386)	3.74 (95)	3.98 (101)	24.3	
7S07-15	283	1	230	.75 ■	30.12 (765)	11.62 (295)	18.51 (470)	3.74 (95)	3.98 (101)	29.7	
7S10-19	358	1	230	1 ■	34.02 (864)	12.21 (310)	21.82 (554)	3.74 (95)	3.98 (101)	32.4	
7S15-26	491	1	230	1.5 ■	41.3 (1049)	13.71 (348)	27.60 (701)	3.74 (95)	3.98 (101)	41.4	
7S, motor dia. 4 inch, 3 wire motor, 60 Hz - rated flow 7 gpm (1" NPT)											
7S05-8	151	1	230	.5 ■	23.75 (603)	11.03 (280)	12.72 (323)	3.74 (95)	3.98 (101)	21.6	
			115	.5 ■	26.23 (666)	11.03 (280)	15.20 (386)	3.74 (95)	3.98 (101)	21.6	
7S05-11	208	1	230	.5 ■	26.23 (666)	11.03 (280)	15.20 (386)	3.74 (95)	3.98 (101)	30.6	
7S07-15	283	1	230	.75 ■	30.12 (765)	11.62 (295)	18.51 (470)	3.74 (95)	3.98 (101)	27.9	
7S10-19	358	1	230	1 ■	34.02 (864)	12.21 (310)	21.82 (554)	3.74 (95)	3.98 (101)	39.6	
			1	230	1.5 ■	41.30 (1049)	13.71 (348)	27.60 (701)	3.74 (95)	38.7	
7S15-26	491	3	230	1.5 ■	39.81 (1011)	12.21 (310)	27.60 (701)	3.74 (95)	3.98 (101)	38.7	
			460	1.5 ■	39.81 (1011)	12.21 (310)	27.60 (701)	3.74 (95)	3.98 (101)	38.7	
			1	230	2 ●	52.05 (1322)	19.49 (495)	32.56 (827)	3.74 (95)	3.98 (101)	48.5
7S20-32	604	3	230	2 ■	46.26 (1175)	13.71 (348)	32.56 (827)	3.74 (95)	3.98 (101)	48.5	
			460	2 ■	46.26 (1175)	13.71 (348)	32.56 (827)	3.74 (95)	3.98 (101)	48.5	

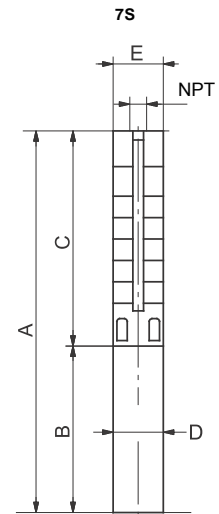

E = Maximum diameter of pump including cable guard and motor.

TN05 0204 0711

Notes:

Control box is required for 3-wire, single-phase applications. Data does not include control box.

DS designation = Built into sleeve, 1 - 1/2" NPT, 6" minimum well diameter.

Performance conforms to ISO 9906. 1999 (E) Annex A. Minimum submergence is 2 feet.

- MS 402 motor.
- MS 4000 motor.

4" and larger wells - continued

SP 10S (10 gpm)

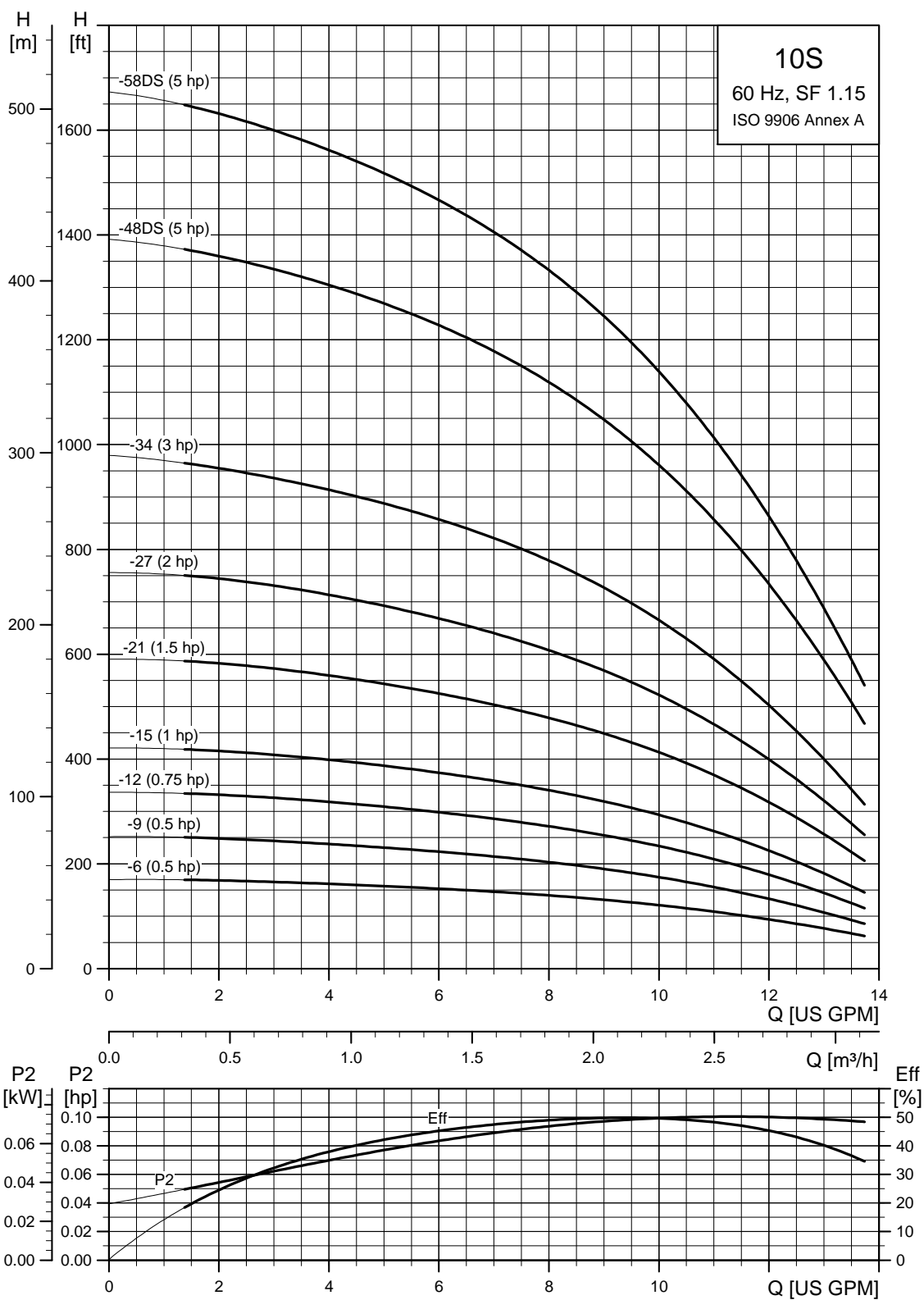

TM05 0230 1812

4" and larger wells - continued

SP 10S (10 gpm) / 4 inch motor

Pump model	Nom. head [ft]	Ph	Volts [V]	Motor [Hp]	Dimensions					Net weight (complete) [lb]		
					A [in. (mm)]	B [in. (mm)]	C [in. (mm)]	D [in. (mm)]	E [in. (mm)]			
10S, motor dia. 4 inch, 2 wire motor, 60 Hz - rated flow 10 gpm (1.25" NPT)												
10S05-6	116	1	230	.5	■	22.05 (560)	10.99 (279)	11.07 (281)	3.74 (95)	3.98 (101)	20.7	
10S05-9	174	1	115	.5	■	24.53 (623)	10.99 (279)	13.55 (344)	3.74 (95)	3.98 (101)	24.3	
			230	.5	■	24.53 (623)	10.99 (279)	13.55 (344)	3.74 (95)	3.98 (101)	23.4	
10S07-12	233	1	230	.75	■	27.60 (701)	11.58 (294)	16.03 (407)	3.74 (95)	3.98 (101)	24.3	
10S10-15	291	1	230	1	■	30.67 (779)	12.17 (309)	18.51 (470)	3.74 (95)	3.98 (101)	29.7	
10S15-21	407	1	230	1.5	■	37.17 (944)	13.71 (348)	23.47 (596)	3.74 (95)	3.98 (101)	35.1	
10S, motor dia. 4 inch, 3 wire motor, 60 Hz - rated flow 10 gpm (1.25" NPT)												
10S05-6	116	1	230	.5	■	24.77 (629)	13.71 (348)	11.07 (281)	3.74 (95)	3.98 (101)	21.6	
10S05-9	174	1	115	.5	■	24.53 (623)	10.99 (279)	13.55 (344)	3.74 (95)	3.98 (101)	25.4	
			230	.5	■	24.53 (623)	10.99 (279)	13.55 (344)	3.74 (95)	3.98 (101)	24.3	
10S07-12	233	1	230	.75	■	27.60 (701)	11.58 (294)	16.03 (407)	3.74 (95)	3.98 (101)	28.8	
10S10-15	291	1	230	1	■	30.67 (779)	12.17 (309)	18.51 (470)	3.74 (95)	3.98 (101)	29.7	
10S15-21	407	3	1	230	1.5	■	37.17 (944)	13.71 (348)	23.47 (596)	3.74 (95)	3.98 (101)	35.1
			230	1.5	■	35.63 (905)	12.17 (309)	23.47 (596)	3.74 (95)	3.98 (101)	32.4	
			460	1.5	■	35.63 (905)	12.17 (309)	23.47 (596)	3.74 (95)	3.98 (101)	36.0	
10S20-27	524	3	1	230	2	●	47.92 (1217)	19.49 (495)	28.43 (722)	3.74 (95)	3.98 (101)	45.9
			230	2	■	42.13 (1070)	13.71 (348)	28.43 (722)	3.74 (95)	3.98 (101)	44.1	
			460	2	■	42.13 (1070)	13.71 (348)	28.43 (722)	3.74 (95)	3.98 (101)	44.1	
10S30-34	659	3	1	230	3	●	58.59 (1488)	22.6 (574)	35.99 (914)	3.74 (95)	3.98 (101)	81.9
			230	3	●	53.98 (1371)	18.00 (457)	35.99 (914)	3.74 (95)	3.98 (101)	74.7	
			460	3	●	53.98 (1371)	18.00 (457)	35.99 (914)	3.74 (95)	3.98 (101)	74.7	
10S50-48DS	931	3	1	230	5	●	74.18 (1884)	26.62 (676)	47.56 (1208)	3.74 (95)	4.25 (108)	103.5
			230	5	●	70.16 (1782)	22.60 (574)	47.56 (1208)	3.74 (95)	4.25 (108)	103.5	
			460	5	●	70.16 (1782)	22.60 (574)	47.56 (1208)	3.74 (95)	4.25 (108)	103.5	
10S50-58DS	1124	3	1	230	5	●	89.49 (2272)	26.62 (676)	62.88 (1597)	3.74 (95)	4.25 (108)	132.3
			230	5	●	85.48 (2171)	22.60 (574)	62.88 (1597)	3.74 (95)	4.25 (108)	132.3	
			460	5	●	85.48 (2171)	22.60 (574)	62.88 (1597)	3.74 (95)	4.25 (108)	132.3	

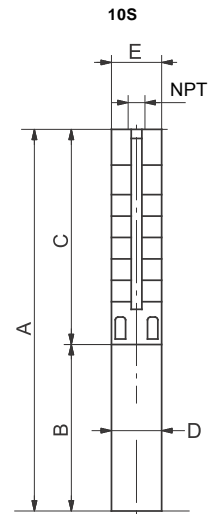

E = Maximum diameter of pump including cable guard and motor.

TN05 02/04 0711

Notes:

Control box is required for 3-wire, single-phase applications. Data does not include control box.

DS designation = Built into sleeve, 1 - 1/2" NPT, 6" minimum well diameter.

Performance conforms to ISO 9906. 1999 (E) Annex A. Minimum submergence is 2 feet.

- MS 402 motor.
- MS 4000 motor.

4" and larger wells - continued

SP 16S (16 gpm)

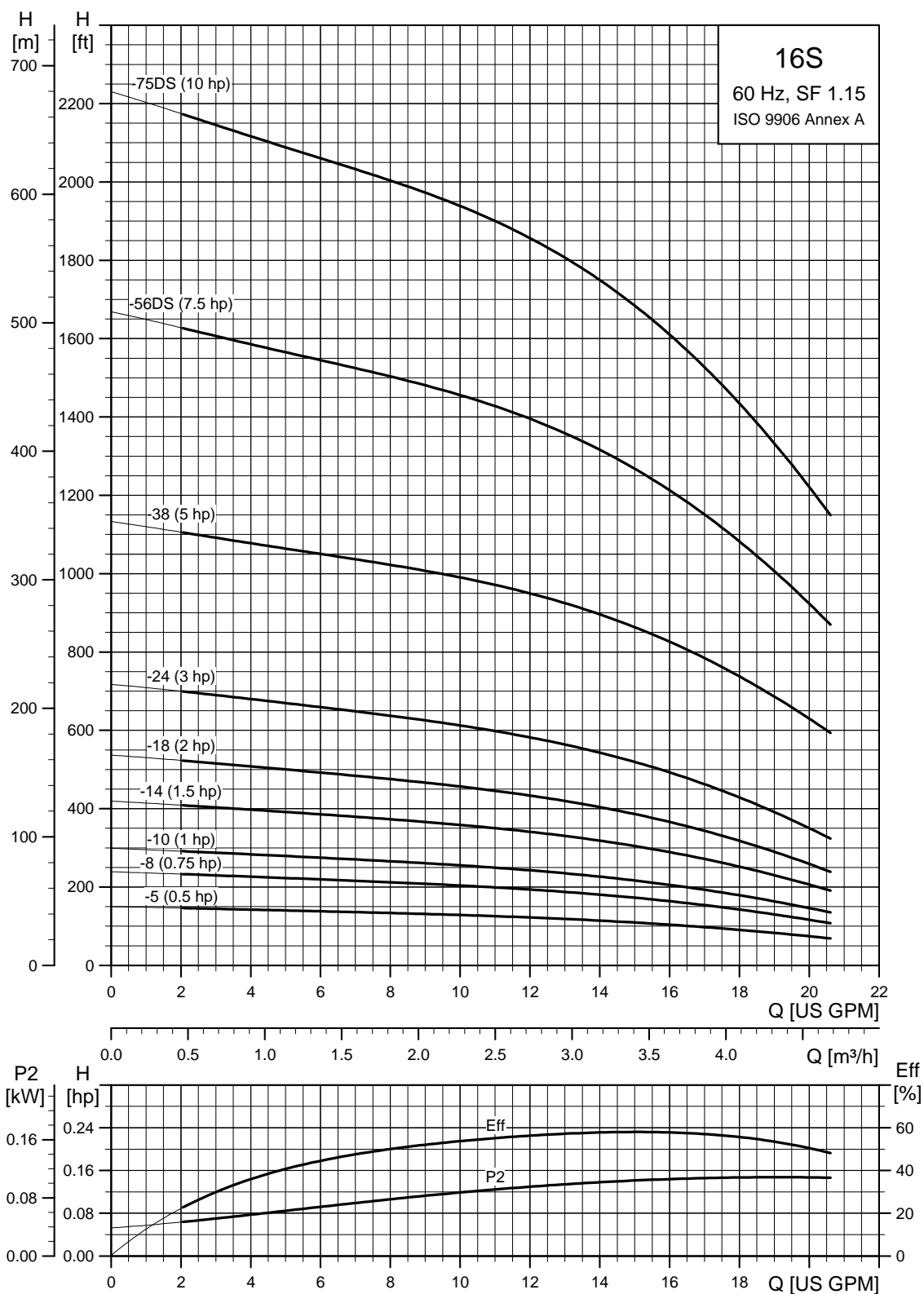

TM05 0231 0112

4" and larger wells - continued

SP 16S (16 gpm) / 4, 6 inch motors

Pump model	Nom. head [ft]	Ph	Volts [V]	Motor [Hp]	Dimensions					Net weight (complete) [lb]		
					A [in. (mm)]	B [in. (mm)]	C [in. (mm)]	D [in. (mm)]	E [in. (mm)]			
16S, motor dia. 4 inch, 2 wire motor, 60 Hz - rated flow 16 gpm (1.25" NPT)												
16S05-5	102	1	115	.5	■	21.26 (540)	11.03 (280)	10.24 (260)	3.74 (95)	3.98 (101)	21.6	
			230	.5	■	21.26 (540)	11.03 (280)	10.24 (260)	3.74 (95)	3.98 (101)	23.4	
16S07-8	162	1	230	.75	■	24.34 (618)	11.62 (295)	12.72 (323)	3.74 (95)	3.98 (101)	24.3	
16S10-10	203	1	230	1	■	26.58 (675)	12.21 (310)	14.38 (365)	3.74 (95)	3.98 (101)	27.9	
16S15-14	284	1	230	1.5	■	31.38 (797)	13.71 (348)	17.68 (449)	3.74 (95)	3.98 (101)	36.0	
16S, motor dia. 4 inch, 3 wire motor, 60 Hz - rated flow 16 gpm (1.25" NPT)												
16S05-5	102	1	115	.5	■	21.26 (540)	11.03 (280)	10.24 (260)	3.74 (95)	3.98 (101)	21.6	
			230	.5	■	21.26 (540)	11.03 (280)	10.24 (260)	3.74 (95)	3.98 (101)	21.6	
16S07-8	162	1	230	.75	■	24.34 (618)	11.62 (295)	12.72 (323)	3.74 (95)	3.98 (101)	27.0	
16S10-10	203	1	230	1	■	26.58 (675)	12.21 (310)	14.38 (365)	3.74 (95)	3.98 (101)	27.9	
16S15-14	284	3	1	230	1.5	●	31.38 (797)	13.71 (348)	17.68 (449)	3.74 (95)	3.98 (101)	32.4
			2	230	1.5	■	29.89 (759)	12.21 (310)	17.68 (449)	3.74 (95)	3.98 (101)	28.8
			3	460	1.5	■	29.89 (759)	12.21 (310)	17.68 (449)	3.74 (95)	3.98 (101)	28.8
16S20-18	366	3	1	230	2	●	40.48 (1028)	19.49 (495)	20.99 (533)	3.74 (95)	3.98 (101)	36.0
			2	230	2	■	34.69 (881)	13.71 (348)	20.99 (533)	3.74 (95)	3.98 (101)	36.0
			3	460	2	■	34.69 (881)	13.71 (348)	20.99 (533)	3.74 (95)	3.98 (101)	36.0
16S30-24	487	3	1	230	3	●	48.55 (1233)	22.60 (574)	25.95 (659)	3.74 (95)	3.98 (101)	62.1
			2	230	3	●	43.94 (1116)	18.00 (457)	25.95 (659)	3.74 (95)	3.98 (101)	57.6
			3	460	3	●	43.94 (1116)	18.00 (457)	25.95 (659)	3.74 (95)	3.98 (101)	57.6
16S50-38	814	3	1	230	5	●	65.91 (1674)	26.62 (676)	39.30 (998)	3.74 (95)	3.98 (101)	97.2
			2	230	5	●	62.01 (1575)	22.72 (577)	39.30 (998)	3.74 (95)	3.98 (101)	90.0
			3	460	5	●	62.01 (1575)	22.72 (577)	39.30 (998)	3.74 (95)	3.98 (101)	90.0
SP 16S, motor dia. 6 inch, 60 Hz - rated flow 16 gpm (1.25" NPT)												
16S75-56DS	1200	3	230	7.5	▲	92.28 (2344)	23.50 (597)	68.78 (1747)	5.63 (143)	5.51 (140)	165.1	
			460	7.5	▲	92.28 (2344)	23.50 (597)	68.78 (1747)	5.63 (143)	5.51 (140)	165.1	
16S100-75DS	1607	3	460	10	▲	109.18 (2773)	24.69 (627)	84.49 (2146)	5.63 (143)	5.51 (140)	190.0	

Notes:

Control box is required for 3-wire, single-phase applications. Data does not include control box.

DS designation = Built into sleeve, 1 - 1/2" NPT, 6" minimum well diameter.

Performance conforms to ISO 9906. 1999 (E) Annex A. Minimum submergence is 2 feet.

- MS 402 motor.
- MS 4000 motor.
- ▲ MS 6000C motor.

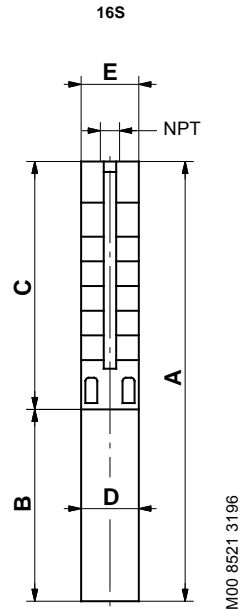

E = Maximum diameter of pump including cable guard and motor.

4" and larger wells - continued SP 25S (25 gpm)

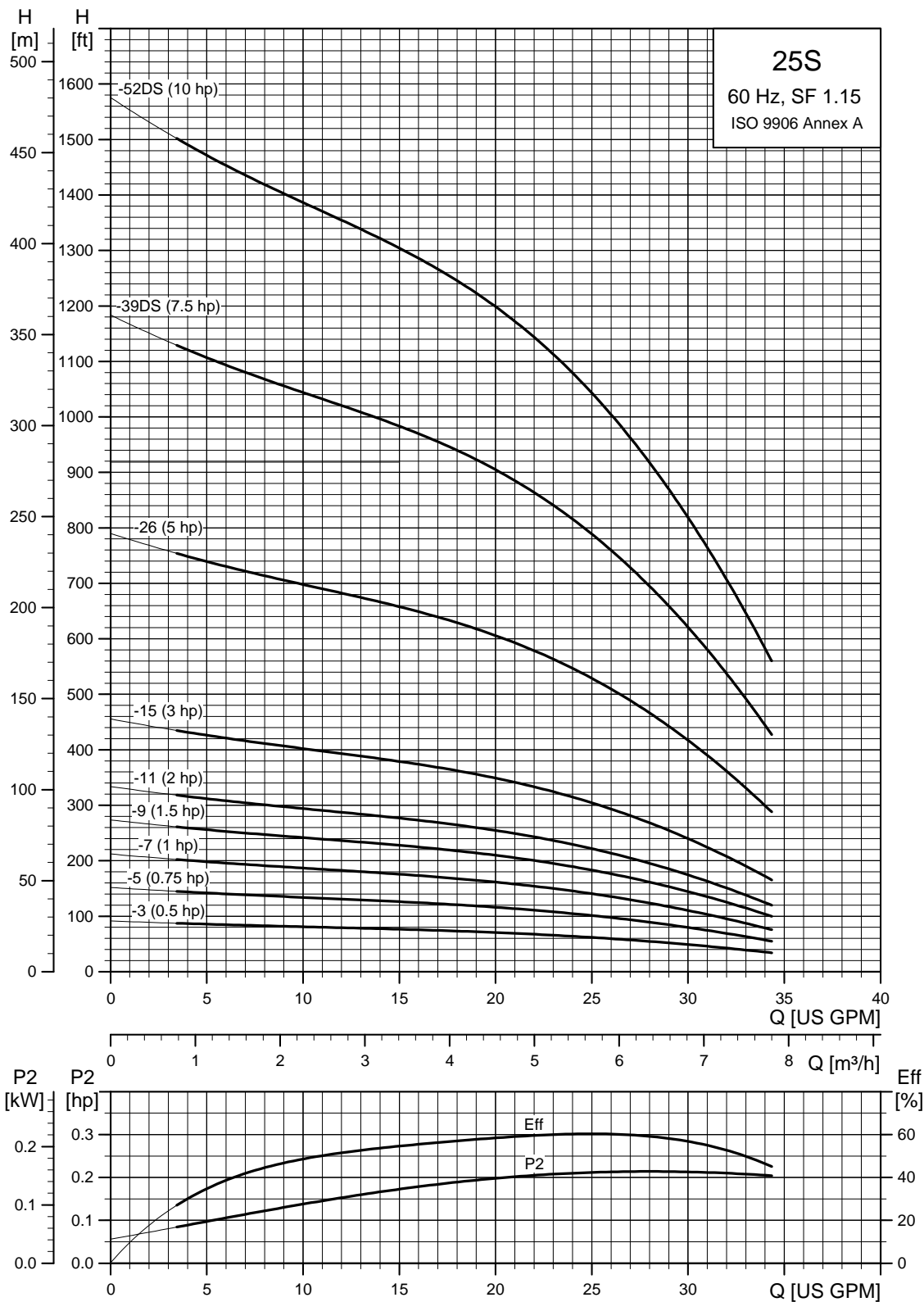

TM05 0232 1812

4" and larger wells - continued

SP 25S (25 gpm) / 4, 6 inch motors

Pump model	Nom. head [ft]	Ph	Volts [V]	Motor [Hp]	Dimensions					Net weight (complete) [lb]		
					A [in. (mm)]	B [in. (mm)]	C [in. (mm)]	D [in. (mm)]	E [in. (mm)]			
25S, motor dia. 4 inch, 2 wire motor, 60 Hz - rated flow 25 gpm (1.5" NPT)												
25S05-3	60	1	115	.5	■	19.61 (498)	11.03 (280)	8.59 (218)	3.74 (95)	3.98 (101)	21.6	
			230	.5	■	19.61 (498)	11.03 (280)	8.59 (218)	3.74 (95)	3.98 (101)	21.6	
25S07-5	99	1	230	.75	■	21.86 (555)	11.62 (295)	10.24 (260)	3.74 (95)	3.98 (101)	23.4	
25S10-7	139	1	230	1	■	24.10 (612)	12.21 (310)	11.89 (302)	3.74 (95)	3.98 (101)	25.2	
25S15-9	179	1	230	1.5	■	27.25 (692)	13.71 (348)	13.55 (344)	3.74 (95)	3.98 (101)	28.8	
25S, motor dia. 4 inch, 3 wire motor, 60 Hz - rated flow 25 gpm (1.5" NPT)												
25S05-3	60	1	115	.5	■	19.61 (498)	11.03 (280)	8.59 (218)	3.74 (95)	3.98 (101)	21.6	
			230	.5	■	19.61 (498)	11.03 (280)	8.59 (218)	3.74 (95)	3.98 (101)	21.6	
25S07-5	99	1	230	.75	■	21.86 (555)	11.62 (295)	10.24 (260)	3.74 (95)	3.98 (101)	23.4	
25S10-7	139	1	230	1	■	24.10 (612)	12.21 (310)	11.89 (302)	3.74 (95)	3.98 (101)	25.2	
25S15-9	179	3	1	230	1.5	■	27.25 (692)	13.71 (348)	13.55 (344)	3.74 (95)	3.98 (101)	29.7
			230	1.5	■	25.75 (654)	12.21 (310)	13.55 (344)	3.74 (95)	3.98 (101)	27.0	
			460	1.5	■	25.75 (654)	12.21 (310)	13.55 (344)	3.74 (95)	3.98 (101)	28.8	
25S20-11	219	3	1	230	2	●	34.69 (881)	19.49 (495)	15.20 (386)	3.74 (95)	3.98 (101)	33.1
			230	2	■	28.90 (734)	13.71 (348)	15.20 (386)	3.74 (95)	3.98 (101)	37.0	
			460	2	■	28.90 (734)	13.71 (348)	15.20 (386)	3.74 (95)	3.98 (101)	33.3	
25S30-15	298	3	1	230	3	●	41.11 (1044)	22.60 (574)	18.51 (470)	3.74 (95)	3.98 (101)	61.2
			230	3	●	36.50 (927)	18.00 (457)	18.51 (470)	3.74 (95)	3.98 (101)	53.1	
			460	3	●	36.50 (927)	18.00 (457)	18.51 (470)	3.74 (95)	3.98 (101)	53.1	
25S50-26	517	3	1	230	5	●	54.22 (1377)	26.62 (676)	27.60 (701)	3.74 (95)	3.98 (101)	72.9
			230	5	●	50.32 (1278)	22.72 (577)	27.60 (701)	3.74 (95)	3.98 (101)	72.9	
			460	5	●	50.32 (1278)	22.72 (577)	27.60 (701)	3.74 (95)	3.98 (101)	72.9	
SP 25S, motor dia. 6 inch, 60 Hz - rated flow 25 gpm (1.5" NPT)												
25S75-39DS	775	3	230	7.5	▲	66.06 (1678)	23.50 (597)	42.56 (1081)	5.63 (143)	5.43 (138)	122.1	
			460	7.5	▲	66.06 (1678)	23.50 (597)	42.56 (1081)	5.63 (143)	5.43 (138)	122.1	
25S100-52DS	1034	3	460	10	▲	90.17 (2290)	24.69 (627)	65.48 (1663)	5.63 (143)	5.51 (140)	163.1	

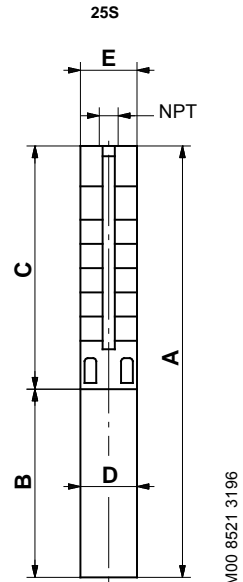

E = Maximum diameter of pump including cable guard and motor.

Notes:

Control box is required for 3-wire, single-phase applications. Data does not include control box.

DS designation = Built into sleeve, 1 - 1/2" NPT, 6" minimum well diameter.

Performance conforms to ISO 9906. 1999 (E) Annex A. Minimum submergence is 2 feet.

- MS 402 motor.
- MS 4000 motor.
- ▲ MS 6000C motor.

4" and larger wells - continued SP 35S (35 gpm)

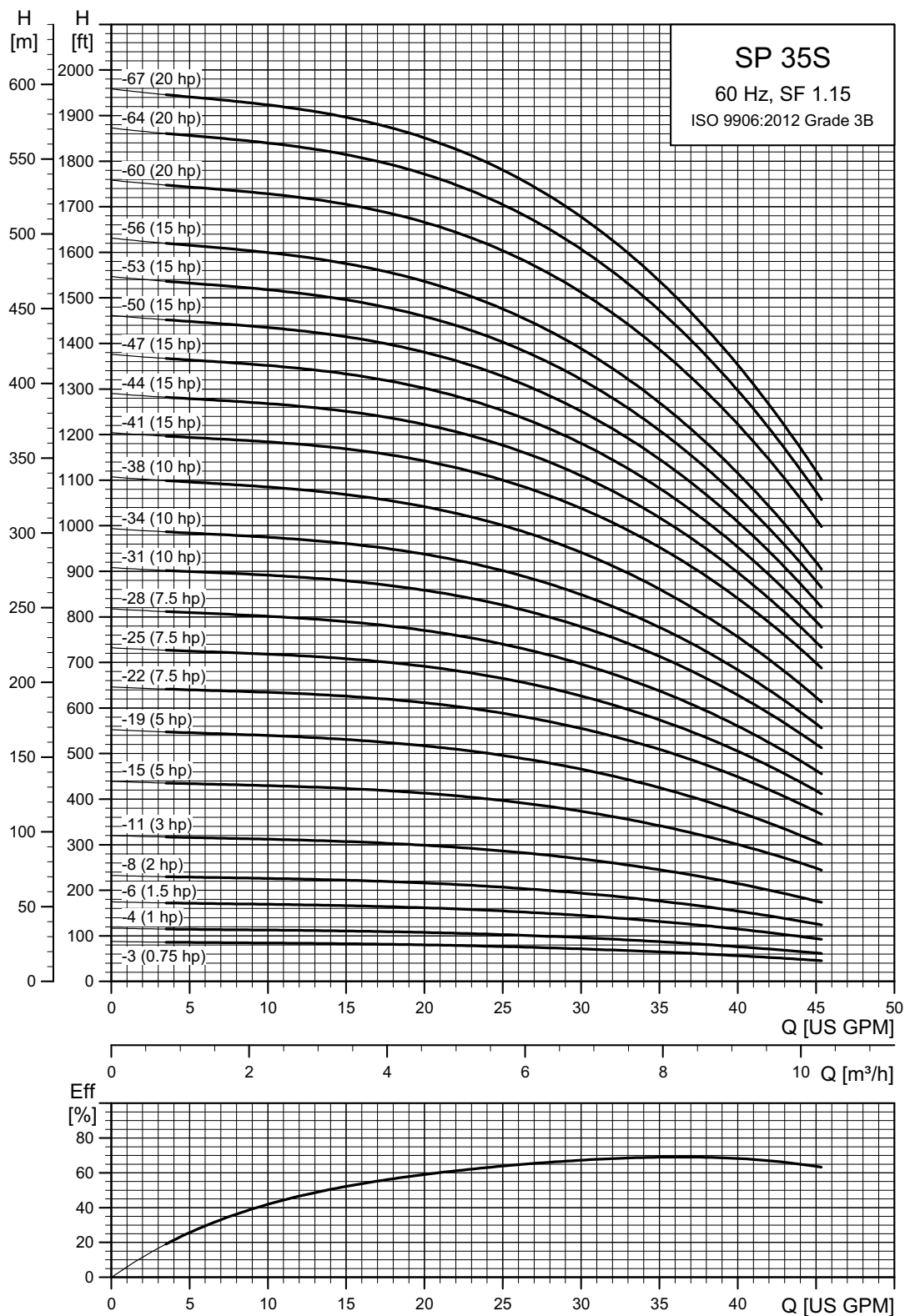

TM06 4614 3215

4" and larger wells - continued

SP 35S (35 gpm) pump power requirement (P2)

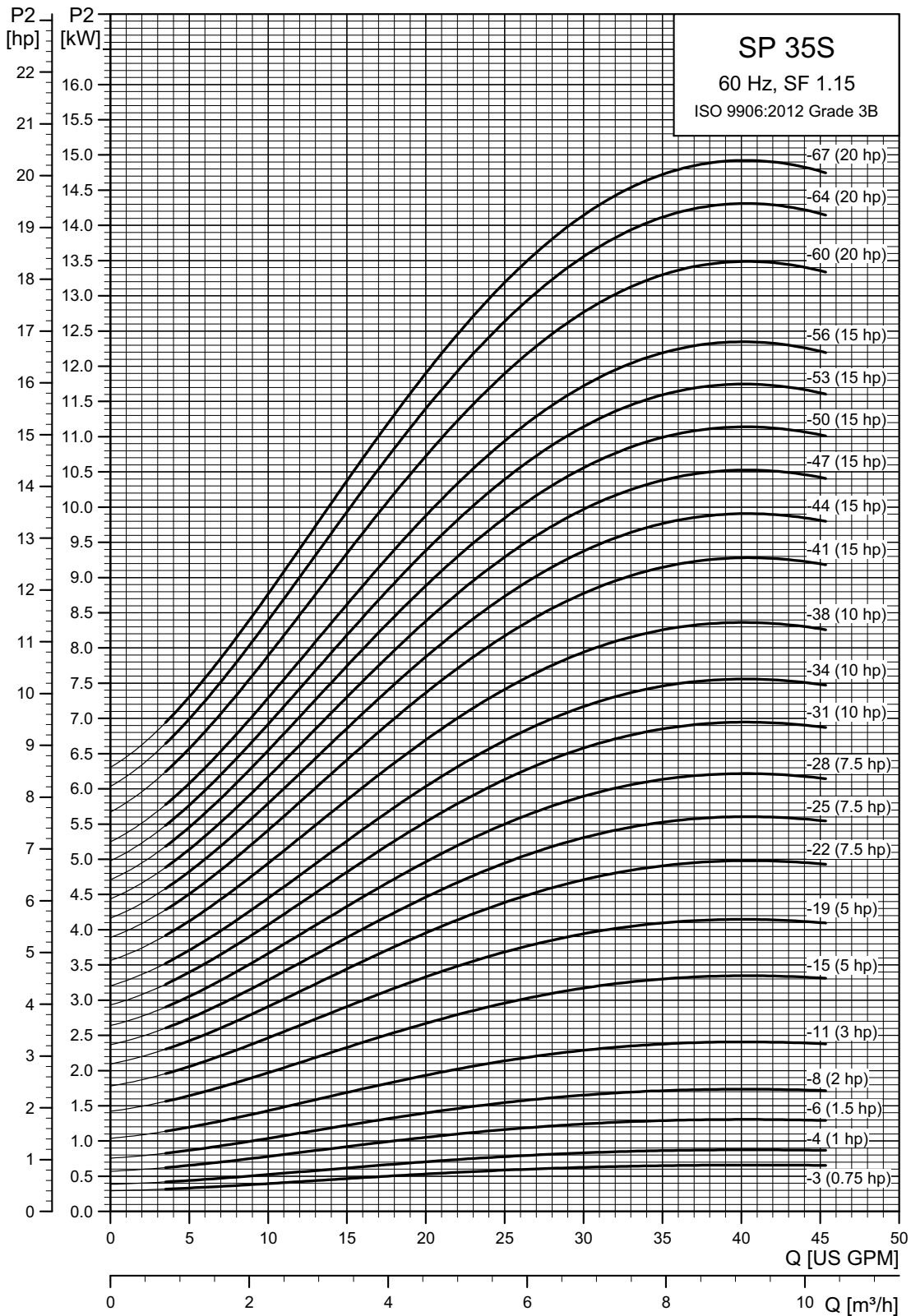

TM06 4615 3215

4" and larger wells - continued

SP 35S (35 gpm) / 4 inch motor

Pump model	Nom. head [ft]	Ph	Volts [V]	Motor [Hp]	Dimensions					Net weight (complete) [lb]	
					A [in. (mm)]	B [in. (mm)]	C [in. (mm)]	D [in. (mm)]	E [in. (mm)]		
35S - Motor dia. 4 inch, 3 wire motor, 60 Hz, rated flow 35 gpm (1 1/2" NPT)											
35S07-3	63	1	230	.75	■	28.35 (720)	13.08 (332)	15.28 (388)	3.75 (95)	3.98 (101)	29.9
		3	230	.75	■	26.97 (685)	11.70 (297)	15.28 (388)	3.75 (95)	3.98 (101)	26.9
		3	460	.75	■	26.97 (685)	11.70 (297)	15.28 (388)	3.75 (95)	3.98 (101)	26.9
		3	575	.75	■	26.97 (685)	11.70 (297)	15.28 (388)	3.75 (95)	3.98 (101)	26.9
35S10-4	85	1	230	1	■	30.91 (785)	13.67 (347)	17.25 (438)	3.75 (95)	3.98 (101)	32.8
		3	230	1	■	29.73 (755)	12.49 (317)	17.25 (438)	3.75 (95)	3.98 (101)	30.1
		3	460	1	■	29.73 (755)	12.49 (317)	17.25 (438)	3.75 (95)	3.98 (101)	29.9
		3	575	1	■	29.73 (755)	12.49 (317)	17.25 (438)	3.75 (95)	3.98 (101)	29.9
35S15-6	130	1	230	1.5	■	36.42 (925)	15.24 (387)	21.19 (538)	3.75 (95)	3.98 (101)	39.1
		3	230	1.5	■	34.85 (885)	13.67 (347)	21.19 (538)	3.75 (95)	3.98 (101)	35.5
		3	460	1.5	■	34.85 (885)	13.67 (347)	21.19 (538)	3.75 (95)	3.98 (101)	35.5
		3	575	1.5	■	34.85 (885)	13.67 (347)	21.19 (538)	3.75 (95)	3.98 (101)	35.3
35S20-8	175	1	230	2	●	44.69 (1135)	19.57 (497)	25.12 (638)	3.75 (95)	3.98 (101)	57.3
		3	230	2	●	40.36 (1025)	15.24 (387)	25.12 (638)	3.75 (95)	3.98 (101)	41.9
		3	460	2	■	40.36 (1025)	15.24 (387)	25.12 (638)	3.75 (95)	3.98 (101)	42.1
		3	575	2	■	40.36 (1025)	15.24 (387)	25.12 (638)	3.75 (95)	3.98 (101)	41.9
35S30-11	242	1	230	3	●	53.75 (1365)	22.72 (577)	31.03 (788)	3.75 (95)	3.98 (101)	69.9
		3	208-230	3	●	49.02 (1245)	18.00 (457)	31.03 (788)	3.75 (95)	3.98 (101)	56.7
		3	460	3	●	49.02 (1245)	18.00 (457)	31.03 (788)	3.75 (95)	3.98 (101)	56.7
		1	230	5	●	65.56 (1665)	26.66 (677)	38.90 (988)	3.75 (95)	3.98 (101)	86.1
35S50-15	331	3	208-230	5	●	61.62 (1565)	22.72 (577)	38.90 (988)	3.75 (95)	3.98 (101)	75.1
		3	460	5	●	61.62 (1565)	22.72 (577)	38.90 (988)	3.75 (95)	3.98 (101)	75.1
		1	230	5	●	73.43 (1865)	26.66 (677)	46.78 (1188)	3.75 (95)	3.98 (101)	91.2
35S50-19	420	3	208-230	5	●	69.49 (1765)	22.72 (577)	46.78 (1188)	3.75 (95)	3.98 (101)	80.2
		3	460	5	●	69.49 (1765)	22.72 (577)	46.78 (1188)	3.75 (95)	3.98 (101)	80.2
		3	208-230	7.5	●	79.34 (2015)	26.66 (677)	52.68 (1338)	3.75 (95)	3.98 (101)	95.0
		3	460	7.5	●	79.34 (2015)	26.66 (677)	52.68 (1338)	3.75 (95)	3.98 (101)	95.0
35S75-22	487	3	460	7.5	●	79.34 (2015)	26.66 (677)	52.68 (1338)	3.75 (95)	3.98 (101)	95.0
		3	575	7.5	●	79.34 (2015)	26.66 (677)	52.68 (1338)	3.75 (95)	3.98 (101)	95.0
		3	208-230	7.5	●	85.24 (2165)	26.66 (677)	58.59 (1488)	3.75 (95)	3.98 (101)	98.9
		3	460	7.5	●	85.24 (2165)	26.66 (677)	58.59 (1488)	3.75 (95)	3.98 (101)	98.9
35S75-25	554	3	575	7.5	●	85.24 (2165)	26.66 (677)	58.59 (1488)	3.75 (95)	3.98 (101)	98.9
		3	208-230	7.5	●	91.15 (2315)	26.66 (677)	64.49 (1638)	3.75 (95)	3.98 (101)	102.7
		3	460	7.5	●	91.15 (2315)	26.66 (677)	64.49 (1638)	3.75 (95)	3.98 (101)	102.7
		3	575	7.5	●	91.15 (2315)	26.66 (677)	64.49 (1638)	3.75 (95)	3.98 (101)	102.7
35S75-28	621	3	460	7.5	●	91.15 (2315)	26.66 (677)	64.49 (1638)	3.75 (95)	3.98 (101)	102.7
		3	575	7.5	●	91.15 (2315)	26.66 (677)	64.49 (1638)	3.75 (95)	3.98 (101)	102.7
		3	208-230	7.5	●	91.15 (2315)	26.66 (677)	64.49 (1638)	3.75 (95)	3.98 (101)	102.7
35S100-31	688	3	460	10	●	100.99 (2565)	30.60 (777)	70.40 (1788)	3.75 (95)	3.98 (101)	115.4
		3	575	10	●	100.99 (2565)	30.60 (777)	70.40 (1788)	3.75 (95)	3.98 (101)	115.4
35S100-34	755	3	460	10	●	106.89 (2715)	30.60 (777)	76.30 (1938)	3.75 (95)	3.98 (101)	119.2
		3	575	10	●	106.89 (2715)	30.60 (777)	76.30 (1938)	3.75 (95)	3.98 (101)	119.2
35S100-38	844	3	460	10	●	114.77 (2915)	30.60 (777)	84.18 (2138)	3.75 (95)	3.98 (101)	124.3
		3	575	10	●	114.77 (2915)	30.60 (777)	84.18 (2138)	3.75 (95)	3.98 (101)	124.3

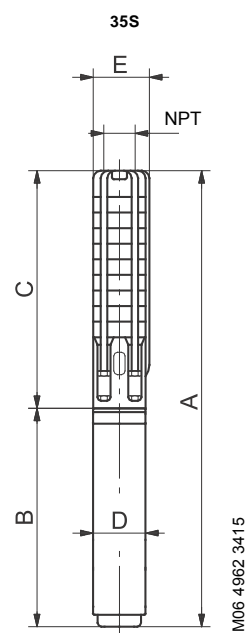

E = Maximum diameter of pump including cable guard and motor.

Notes:

Control box is required for 3-wire, single-phase applications. Data does not include control box. Performance conforms to ISO 9906: 1999 (E) Annex A. Minimum submergence is 2 feet.

- MS 402 motor.
- MS 4000 motor.

4" and larger wells - continued

SP 35S (35 gpm) / 6 inch motor

Pump model	Nom. head [ft]	Ph	Volts [V]	Motor [Hp]	Dimensions					Net weight (complete) [lb]
					A [in. (mm)]	B [in. (mm)]	C [in. (mm)]	D [in. (mm)]	E [in. (mm)]	
35S - Motor dia. 6 inch, 60 Hz, rated flow 35 gpm (1 1/2" NPT)										
35S75-22	487	3	208-230	7.5	▲ 78.67 (1998)	23.51 (597)	55.16 (1401)	5.50 (140)	5.50 (140)	123.6
		3	460	7.5	▲ 78.67 (1998)	23.51 (597)	55.16 (1401)	5.50 (140)	5.50 (140)	123.6
		3	575	7.5	▲ 78.67 (1998)	23.51 (597)	55.16 (1401)	5.50 (140)	5.50 (140)	123.6
35S75-25	554	3	208-230	7.5	▲ 84.57 (2148)	23.51 (597)	61.07 (1551)	5.50 (140)	5.50 (140)	127.5
		3	460	7.5	▲ 84.57 (2148)	23.51 (597)	61.07 (1551)	5.50 (140)	5.50 (140)	127.5
		3	575	7.5	▲ 84.57 (2148)	23.51 (597)	61.07 (1551)	5.50 (140)	5.50 (140)	127.5
35S75-28	621	3	208-230	7.5	▲ 90.48 (2298)	23.51 (597)	66.97 (1701)	5.50 (140)	5.50 (140)	131.4
		3	460	7.5	▲ 90.48 (2298)	23.51 (597)	66.97 (1701)	5.50 (140)	5.50 (140)	131.4
		3	575	7.5	▲ 90.48 (2298)	23.51 (597)	66.97 (1701)	5.50 (140)	5.50 (140)	131.4
35S100-31	688	3	208-230	10	▲ 97.56 (2478)	24.69 (627)	72.88 (1851)	5.50 (140)	5.50 (140)	142.0
		3	460	10	▲ 97.56 (2478)	24.69 (627)	72.88 (1851)	5.50 (140)	5.50 (140)	142.0
		3	575	10	▲ 97.56 (2478)	24.69 (627)	72.88 (1851)	5.50 (140)	5.50 (140)	142.0
35S100-34	755	3	208-230	10	▲ 103.47 (2628)	24.69 (627)	78.78 (2001)	5.50 (140)	5.50 (140)	145.9
		3	460	10	▲ 103.47 (2628)	24.69 (627)	78.78 (2001)	5.50 (140)	5.50 (140)	145.9
		3	575	10	▲ 103.47 (2628)	24.69 (627)	78.78 (2001)	5.50 (140)	5.50 (140)	145.9
35S100-38	844	3	208-230	10	▲ 111.34 (2828)	24.69 (627)	86.66 (2201)	5.50 (140)	5.50 (140)	151.1
		3	460	10	▲ 111.34 (2828)	24.69 (627)	86.66 (2201)	5.50 (140)	5.50 (140)	151.1
		3	575	10	▲ 111.34 (2828)	24.69 (627)	86.66 (2201)	5.50 (140)	5.50 (140)	151.1

Notes:

Control box is required for 3-wire, single-phase applications. Data does not include control box. Performance conforms to ISO 9906. 1999 (E) Annex A. Minimum submergence is 2 feet.

▲ MS 6000C motor.

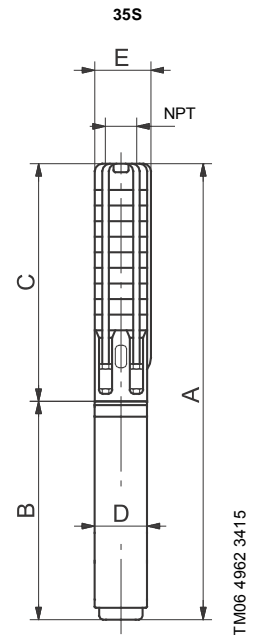

E = Maximum diameter of pump including cable guard and motor.

TM06 4962 3415

4" and larger wells - continued

SP 35S (35 gpm) / 6 inch motor

Pump model	Nom. head [ft]	Ph	Volts [V]	Motor [Hp]	Dimensions					Net weight (complete) [lb]
					A [in. (mm)]	B [in. (mm)]	C [in. (mm)]	D [in. (mm)]	E [in. (mm)]	
35S - Motor dia. 6 inch, 60 Hz, rated flow 35 gpm (2" NPT)										
35S150-41DS	911	3	208-230	15	▲ 131.23 (3333)	27.05 (687)	104.18 (2646)	5.50 (140)	5.50 (140)	217.3
		3	460	15	▲ 131.23 (3333)	27.05 (687)	104.18 (2646)	5.50 (140)	5.50 (140)	217.3
		3	575	15	▲ 131.23 (3333)	27.05 (687)	104.18 (2646)	5.50 (140)	5.50 (140)	217.3
35S150-44DS	978	3	208-230	15	▲ 137.13 (3483)	27.05 (687)	110.08 (2796)	5.50 (140)	5.50 (140)	223.1
		3	460	15	▲ 137.13 (3483)	27.05 (687)	110.08 (2796)	5.50 (140)	5.50 (140)	223.1
		3	575	15	▲ 137.13 (3483)	27.05 (687)	110.08 (2796)	5.50 (140)	5.50 (140)	223.1
35S150-47DS	1044	3	208-230	15	▲ 143.04 (3633)	27.05 (687)	115.99 (2946)	5.50 (140)	5.50 (140)	228.8
		3	460	15	▲ 143.04 (3633)	27.05 (687)	115.99 (2946)	5.50 (140)	5.50 (140)	228.8
		3	575	15	▲ 143.04 (3633)	27.05 (687)	115.99 (2946)	5.50 (140)	5.50 (140)	228.8
35S150-50DS	1111	3	208-230	15	▲ 148.94 (3783)	27.05 (687)	121.89 (3096)	5.50 (140)	5.50 (140)	234.6
		3	460	15	▲ 148.94 (3783)	27.05 (687)	121.89 (3096)	5.50 (140)	5.50 (140)	234.6
		3	575	15	▲ 148.94 (3783)	27.05 (687)	121.89 (3096)	5.50 (140)	5.50 (140)	234.6
35S150-53DS	1178	3	208-230	15	▲ 154.85 (3933)	27.05 (687)	127.80 (3246)	5.50 (140)	5.50 (140)	240.3
		3	460	15	▲ 154.85 (3933)	27.05 (687)	127.80 (3246)	5.50 (140)	5.50 (140)	240.3
		3	575	15	▲ 154.85 (3933)	27.05 (687)	127.80 (3246)	5.50 (140)	5.50 (140)	240.3
35S150-56DS	1245	3	208-230	15	▲ 160.75 (4083)	27.05 (687)	133.71 (3396)	5.50 (140)	5.50 (140)	246.1
		3	460	15	▲ 160.75 (4083)	27.05 (687)	133.71 (3396)	5.50 (140)	5.50 (140)	246.1
		3	575	15	▲ 160.75 (4083)	27.05 (687)	133.71 (3396)	5.50 (140)	5.50 (140)	246.1
35S200-60DS	1334	3	208-230	20	▲ 171.19 (4348)	29.61 (752)	141.58 (3596)	5.50 (140)	5.50 (140)	269.2
		3	460	20	▲ 171.19 (4348)	29.61 (752)	141.58 (3596)	5.50 (140)	5.50 (140)	269.2
		3	575	20	▲ 171.19 (4348)	29.61 (752)	141.58 (3596)	5.50 (140)	5.50 (140)	269.2
35S200-64DS	1424	3	208-230	20	▲ 179.06 (4548)	29.61 (752)	149.45 (3796)	5.50 (140)	5.50 (140)	276.9
		3	460	20	▲ 179.06 (4548)	29.61 (752)	149.45 (3796)	5.50 (140)	5.50 (140)	276.9
		3	575	20	▲ 179.06 (4548)	29.61 (752)	149.45 (3796)	5.50 (140)	5.50 (140)	276.9
35S200-67DS	1491	3	208-230	20	▲ 184.97 (4698)	29.61 (752)	155.36 (3946)	5.50 (140)	5.50 (140)	282.7
		3	460	20	▲ 184.97 (4698)	29.61 (752)	155.36 (3946)	5.50 (140)	5.50 (140)	282.7
		3	575	20	▲ 184.97 (4698)	29.61 (752)	155.36 (3946)	5.50 (140)	5.50 (140)	282.7

Notes:

Control box is required for 3-wire, single-phase applications. Data does not include control box.

DS designation = Built into sleeve, 2" NPT, 6" minimum well diameter.

Performance conforms to ISO 9906. 1999 (E) Annex A. Minimum submergence is 2 feet.

▲ MS 6000C motor.

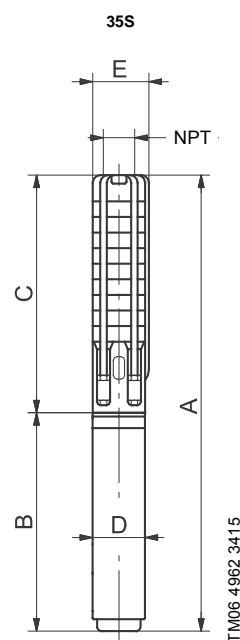

E = Maximum diameter of pump including cable guard and motor.

4" and larger wells - continued

SP 45S (45 gpm)

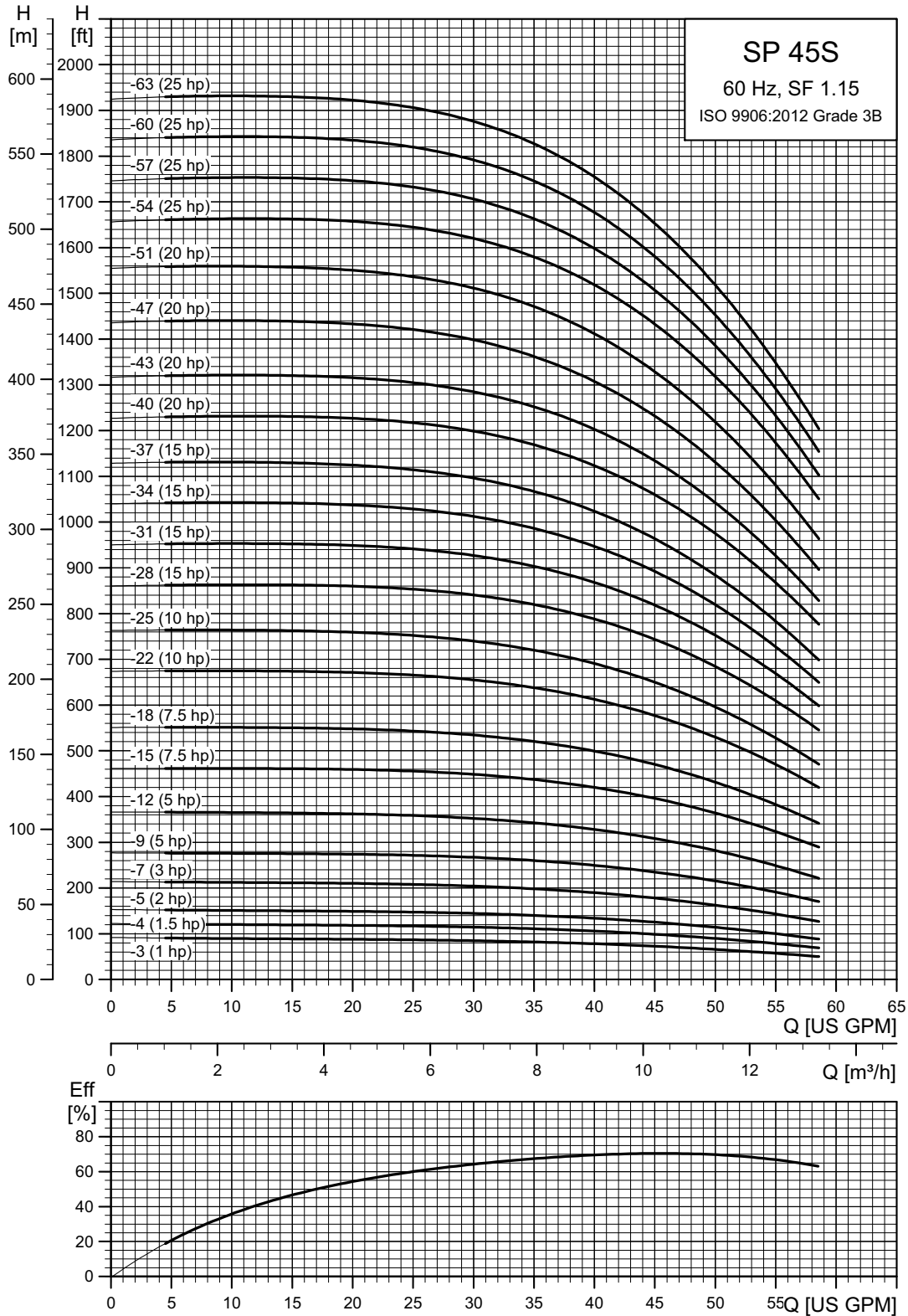

4" and larger wells - continued

SP 45S (45 gpm) pump power requirement (P2)

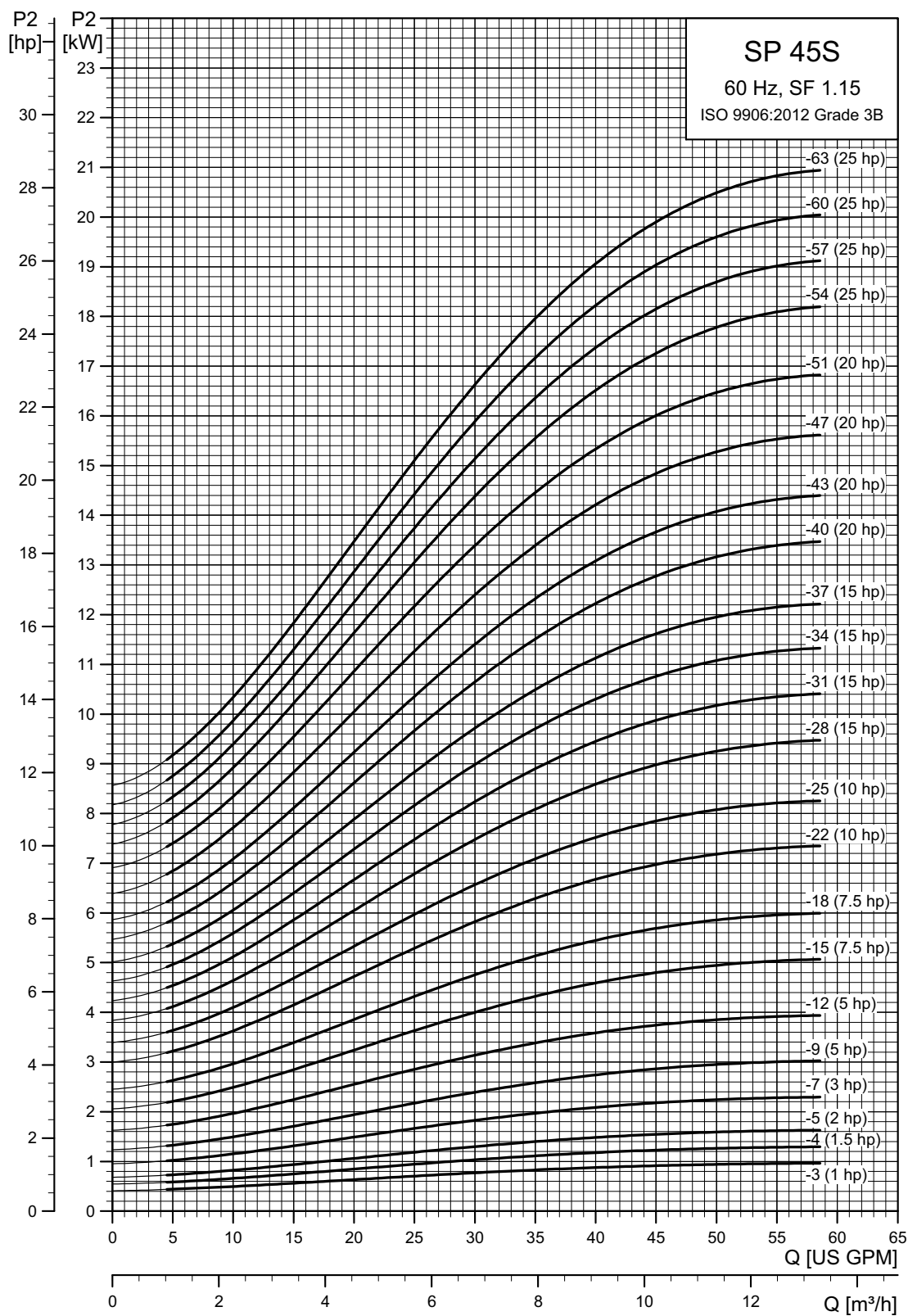

TM06 4617 3215

4" and larger wells - continued

SP 45S (45 gpm) / 4 inch motor

Pump model	Nom. head [ft]	Ph	Volts [V]	Motor [Hp]	Dimensions					Net weight (complete) [lb]	
					A [in. (mm)]	B [in. (mm)]	C [in. (mm)]	D [in. (mm)]	E [in. (mm)]		
45S - Motor dia. 4 inch, 3 wire motor, 60 Hz, rated flow 45 gpm (2" NPT)											
45S10-3	72	1	230	1	■	28.94 (735)	13.67 (347)	15.28 (388)	3.75 (95)	3.98 (101)	31.5
		3	230	1	■	27.76 (705)	12.49 (317)	15.28 (388)	3.75 (95)	3.98 (101)	28.8
		3	460	1	■	27.76 (705)	12.49 (317)	15.28 (388)	3.75 (95)	3.98 (101)	28.6
		3	575	1	■	27.76 (705)	12.49 (317)	15.28 (388)	3.75 (95)	3.98 (101)	28.6
45S15-4	97	1	230	1.5	■	32.49 (825)	15.24 (387)	17.25 (438)	3.75 (95)	3.98 (101)	36.5
		3	230	1.5	■	30.91 (785)	13.67 (347)	17.25 (438)	3.75 (95)	3.98 (101)	33.0
		3	460	1.5	■	30.91 (785)	13.67 (347)	17.25 (438)	3.75 (95)	3.98 (101)	33.0
45S20-5	123	3	575	1.5	■	30.91 (785)	13.67 (347)	17.25 (438)	3.75 (95)	3.98 (101)	32.8
		1	230	2	●	38.78 (985)	19.57 (497)	19.22 (488)	3.75 (95)	3.98 (101)	53.4
		3	230	2	■	34.45 (875)	15.24 (387)	19.22 (488)	3.75 (95)	3.98 (101)	38.0
45S30-7	174	3	460	2	■	34.45 (875)	15.24 (387)	19.22 (488)	3.75 (95)	3.98 (101)	38.2
		3	575	2	■	34.45 (875)	15.24 (387)	19.22 (488)	3.75 (95)	3.98 (101)	38.0
		1	230	3	●	45.87 (1165)	22.72 (577)	23.15 (588)	3.75 (95)	3.98 (101)	64.8
45S50-9	225	3	208-230	3	●	41.15 (1045)	18.00 (457)	23.15 (588)	3.75 (95)	3.98 (101)	51.6
		3	460	3	●	41.15 (1045)	18.00 (457)	23.15 (588)	3.75 (95)	3.98 (101)	51.6
		1	230	5	●	53.75 (1365)	26.66 (677)	27.09 (688)	3.75 (95)	3.98 (101)	78.4
45S50-12	302	3	208-230	5	●	49.81 (1265)	22.72 (577)	27.09 (688)	3.75 (95)	3.98 (101)	67.4
		3	460	5	●	49.81 (1265)	22.72 (577)	27.09 (688)	3.75 (95)	3.98 (101)	67.4
		1	230	5	●	59.65 (1515)	26.66 (677)	33.00 (838)	3.75 (95)	3.98 (101)	82.2
45S75-15	379	3	208-230	5	●	55.71 (1415)	22.72 (577)	33.00 (838)	3.75 (95)	3.98 (101)	71.2
		3	460	5	●	55.71 (1415)	22.72 (577)	33.00 (838)	3.75 (95)	3.98 (101)	71.2
		3	208-230	7.5	●	65.56 (1665)	26.66 (677)	38.90 (988)	3.75 (95)	3.98 (101)	86.1
45S75-18	455	3	460	7.5	●	65.56 (1665)	26.66 (677)	38.90 (988)	3.75 (95)	3.98 (101)	86.1
		3	575	7.5	●	65.56 (1665)	26.66 (677)	38.90 (988)	3.75 (95)	3.98 (101)	86.1
		3	208-230	7.5	●	71.46 (1815)	26.66 (677)	44.81 (1138)	3.75 (95)	3.98 (101)	89.9
45S100-22	558	3	460	7.5	●	71.46 (1815)	26.66 (677)	44.81 (1138)	3.75 (95)	3.98 (101)	89.9
		3	575	7.5	●	71.46 (1815)	26.66 (677)	44.81 (1138)	3.75 (95)	3.98 (101)	89.9
		3	460	10	●	83.27 (2115)	30.60 (777)	52.68 (1338)	3.75 (95)	3.98 (101)	103.8
45S100-25	634	3	575	10	●	83.27 (2115)	30.60 (777)	52.68 (1338)	3.75 (95)	3.98 (101)	103.8
		3	460	10	●	89.18 (2265)	30.60 (777)	58.59 (1488)	3.75 (95)	3.98 (101)	107.7
		3	575	10	●	89.18 (2265)	30.60 (777)	58.59 (1488)	3.75 (95)	3.98 (101)	107.7

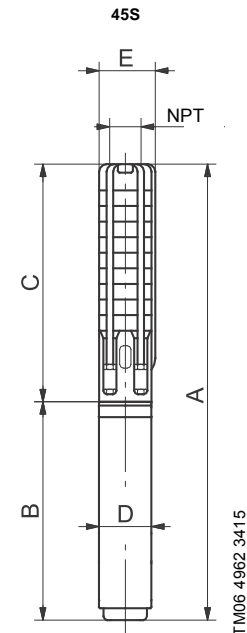

E = Maximum diameter of pump including cable guard and motor.

Notes:

Control box is required for 3-wire, single-phase applications. Data does not include control box. Performance conforms to ISO 9906: 1999 (E) Annex A. Minimum submergence is 2 feet.

- MS 402 motor.
- MS 4000 motor.

4" and larger wells - continued

SP 45S (45 gpm) / 6 inch motor

Pump model	Nom. head [ft]	Ph	Volts [V]	Motor [Hp]	Dimensions					Net weight (complete) [lb]
					A [in. (mm)]	B [in. (mm)]	C [in. (mm)]	D [in. (mm)]	E [in. (mm)]	
45S - Motor dia. 6 inch, 60 Hz, rated flow 45 gpm (2" NPT)										
45S75-15	379	3	208-230	7.5	▲ 64.89 (1648)	23.51 (597)	41.38 (1051)	5.50 (140)	5.50 (140)	114.4
		3	460	7.5	▲ 64.89 (1648)	23.51 (597)	41.38 (1051)	5.50 (140)	5.50 (140)	114.4
		3	575	7.5	▲ 64.89 (1648)	23.51 (597)	41.38 (1051)	5.50 (140)	5.50 (140)	114.4
45S75-18	455	3	208-230	7.5	▲ 70.79 (1798)	23.51 (597)	47.29 (1201)	5.50 (140)	5.50 (140)	118.3
		3	460	7.5	▲ 70.79 (1798)	23.51 (597)	47.29 (1201)	5.50 (140)	5.50 (140)	118.3
		3	575	7.5	▲ 70.79 (1798)	23.51 (597)	47.29 (1201)	5.50 (140)	5.50 (140)	118.3
45S100-22	558	3	208-230	10	▲ 79.85 (2028)	24.69 (627)	55.16 (1401)	5.50 (140)	5.50 (140)	130.2
		3	460	10	▲ 79.85 (2028)	24.69 (627)	55.16 (1401)	5.50 (140)	5.50 (140)	130.2
		3	575	10	▲ 79.85 (2028)	24.69 (627)	55.16 (1401)	5.50 (140)	5.50 (140)	130.2
45S100-25	634	3	208-230	10	▲ 85.75 (2178)	24.69 (627)	61.07 (1551)	5.50 (140)	5.50 (140)	134.1
		3	460	10	▲ 85.75 (2178)	24.69 (627)	61.07 (1551)	5.50 (140)	5.50 (140)	134.1
		3	575	10	▲ 85.75 (2178)	24.69 (627)	61.07 (1551)	5.50 (140)	5.50 (140)	134.1
45S150-28	711	3	208-230	15	▲ 94.02 (2388)	27.05 (687)	66.97 (1701)	5.50 (140)	5.50 (140)	160.6
		3	460	15	▲ 94.02 (2388)	27.05 (687)	66.97 (1701)	5.50 (140)	5.50 (140)	160.6
		3	575	15	▲ 94.02 (2388)	27.05 (687)	66.97 (1701)	5.50 (140)	5.50 (140)	160.6
45S150-31	788	3	208-230	15	▲ 99.93 (2538)	27.05 (687)	72.88 (1851)	5.50 (140)	5.50 (140)	164.7
		3	460	15	▲ 99.93 (2538)	27.05 (687)	72.88 (1851)	5.50 (140)	5.50 (140)	164.7
		3	575	15	▲ 99.93 (2538)	27.05 (687)	72.88 (1851)	5.50 (140)	5.50 (140)	164.7
45S150-34	864	3	208-230	15	▲ 105.83 (2688)	27.05 (687)	78.78 (2001)	5.50 (140)	5.50 (140)	168.8
		3	460	15	▲ 105.83 (2688)	27.05 (687)	78.78 (2001)	5.50 (140)	5.50 (140)	168.8
		3	575	15	▲ 105.83 (2688)	27.05 (687)	78.78 (2001)	5.50 (140)	5.50 (140)	168.8
45S150-37	941	3	208-230	15	▲ 111.74 (2838)	27.05 (687)	84.69 (2151)	5.50 (140)	5.50 (140)	172.9
		3	460	15	▲ 111.74 (2838)	27.05 (687)	84.69 (2151)	5.50 (140)	5.50 (140)	172.9
		3	575	15	▲ 111.74 (2838)	27.05 (687)	84.69 (2151)	5.50 (140)	5.50 (140)	172.9
45S200-40DS	1018	3	208-230	20	▲ 131.82 (3348)	29.61 (752)	102.21 (2596)	5.50 (140)	5.50 (140)	230.8
		3	460	20	▲ 131.82 (3348)	29.61 (752)	102.21 (2596)	5.50 (140)	5.50 (140)	230.8
		3	575	20	▲ 131.82 (3348)	29.61 (752)	102.21 (2596)	5.50 (140)	5.50 (140)	230.8
45S200-43DS	1095	3	208-230	20	▲ 137.72 (3498)	29.61 (752)	108.12 (2746)	5.50 (140)	5.50 (140)	236.6
		3	460	20	▲ 137.72 (3498)	29.61 (752)	108.12 (2746)	5.50 (140)	5.50 (140)	236.6
		3	575	20	▲ 137.72 (3498)	29.61 (752)	108.12 (2746)	5.50 (140)	5.50 (140)	236.6
45S200-47DS	1197	3	208-230	20	▲ 145.60 (3698)	29.61 (752)	115.99 (2946)	5.50 (140)	5.50 (140)	244.2
		3	460	20	▲ 145.60 (3698)	29.61 (752)	115.99 (2946)	5.50 (140)	5.50 (140)	244.2
		3	575	20	▲ 145.60 (3698)	29.61 (752)	115.99 (2946)	5.50 (140)	5.50 (140)	244.2
45S200-51DS	1299	3	208-230	20	▲ 153.47 (3898)	29.61 (752)	123.86 (3146)	5.50 (140)	5.50 (140)	251.9
		3	460	20	▲ 153.47 (3898)	29.61 (752)	123.86 (3146)	5.50 (140)	5.50 (140)	251.9
		3	575	20	▲ 153.47 (3898)	29.61 (752)	123.86 (3146)	5.50 (140)	5.50 (140)	251.9

Notes:

Control box is required for 3-wire, single-phase applications. Data does not include control box.

DS designation = Built into sleeve, 2" NPT, 6" minimum well diameter.

Performance conforms to ISO 9906. 1999 (E) Annex A. Minimum submergence is 2 feet.

▲ MS 6000C motor.

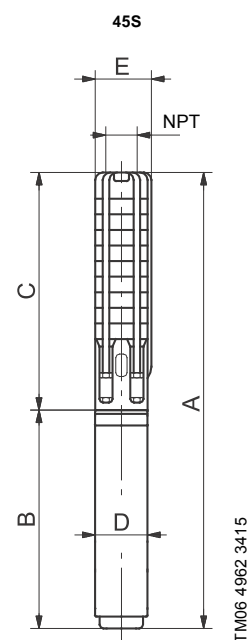

E = Maximum diameter of pump including cable guard and motor.

4" and larger wells - continued

SP 45S (45 gpm) / 6 inch motor

Pump model	Nom. head [ft]	Ph	Volts [V]	Motor [Hp]	Dimensions					Net weight (complete) [lb]
					A [in. (mm)]	B [in. (mm)]	C [in. (mm)]	D [in. (mm)]	E [in. (mm)]	
45S - Motor dia. 6 inch, 60 Hz, rated flow 45 gpm (2" NPT)										
45S250-54DS	1376	3	208-230	25	▲ 161.54 (4103)	31.78 (807)	129.77 (3296)	5.50 (140)	5.50 (140)	267.6
		3	460	25	▲ 161.54 (4103)	31.78 (807)	129.77 (3296)	5.50 (140)	5.50 (140)	267.6
		3	575	25	▲ 161.54 (4103)	31.78 (807)	129.77 (3296)	5.50 (140)	5.50 (140)	267.6
45S250-57DS	1453	3	208-230	25	▲ 167.45 (4253)	31.78 (807)	135.67 (3446)	5.50 (140)	5.50 (140)	273.4
		3	460	25	▲ 167.45 (4253)	31.78 (807)	135.67 (3446)	5.50 (140)	5.50 (140)	273.4
		3	575	25	▲ 167.45 (4253)	31.78 (807)	135.67 (3446)	5.50 (140)	5.50 (140)	273.4
45S250-60DS	1529	3	208-230	25	▲ 173.35 (4403)	31.78 (807)	141.58 (3596)	5.50 (140)	5.50 (140)	279.1
		3	460	25	▲ 173.35 (4403)	31.78 (807)	141.58 (3596)	5.50 (140)	5.50 (140)	279.1
		3	575	25	▲ 173.35 (4403)	31.78 (807)	141.58 (3596)	5.50 (140)	5.50 (140)	279.1
45S250-63DS	1606	3	208-230	25	▲ 167.64 (4258)	31.78 (807)	135.87 (3451)	5.50 (140)	5.50 (140)	233.7
		3	460	25	▲ 167.64 (4258)	31.78 (807)	135.87 (3451)	5.50 (140)	5.50 (140)	233.7
		3	575	25	▲ 167.64 (4258)	31.78 (807)	135.87 (3451)	5.50 (140)	5.50 (140)	233.7

Notes:

Control box is required for 3-wire, single-phase applications. Data does not include control box.

DS designation = Built into sleeve, 2" NPT, 6" minimum well diameter.

Performance conforms to ISO 9906: 1999 (E) Annex A. Minimum submergence is 2 feet.

▲ MS 6000C motor.

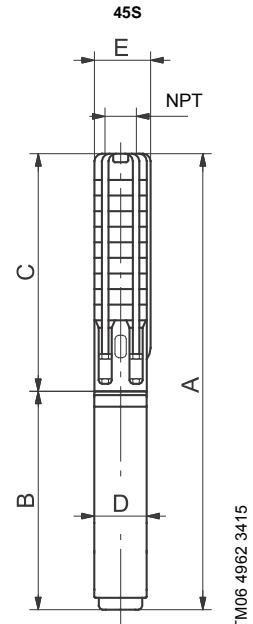

E = Maximum diameter of pump including cable guard and motor.

4" and larger wells - continued

SP 62S (62 gpm)

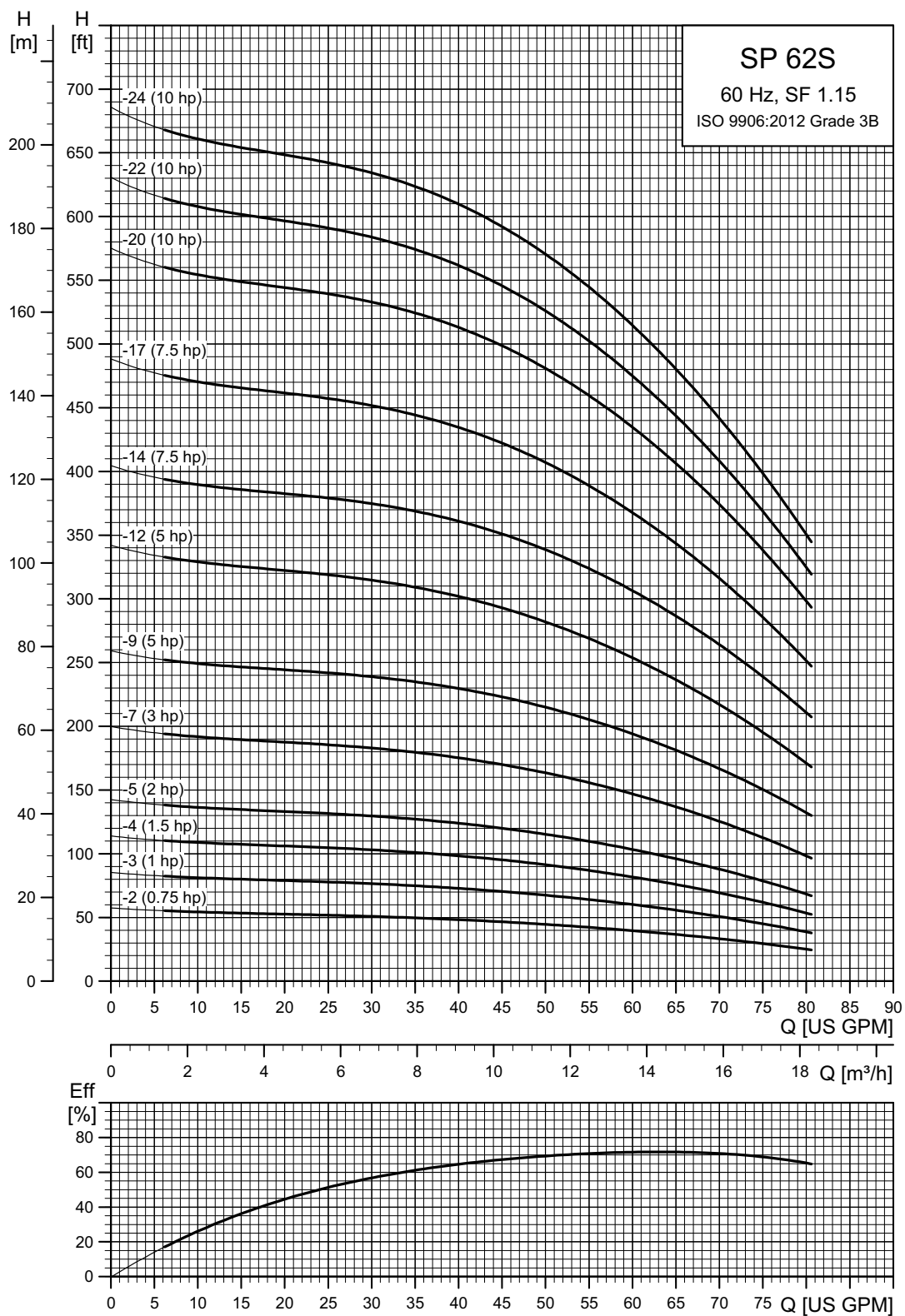

TM06 4618 3215

4" and larger wells - continued

SP 62S (62 gpm) pump power requirement (P2)

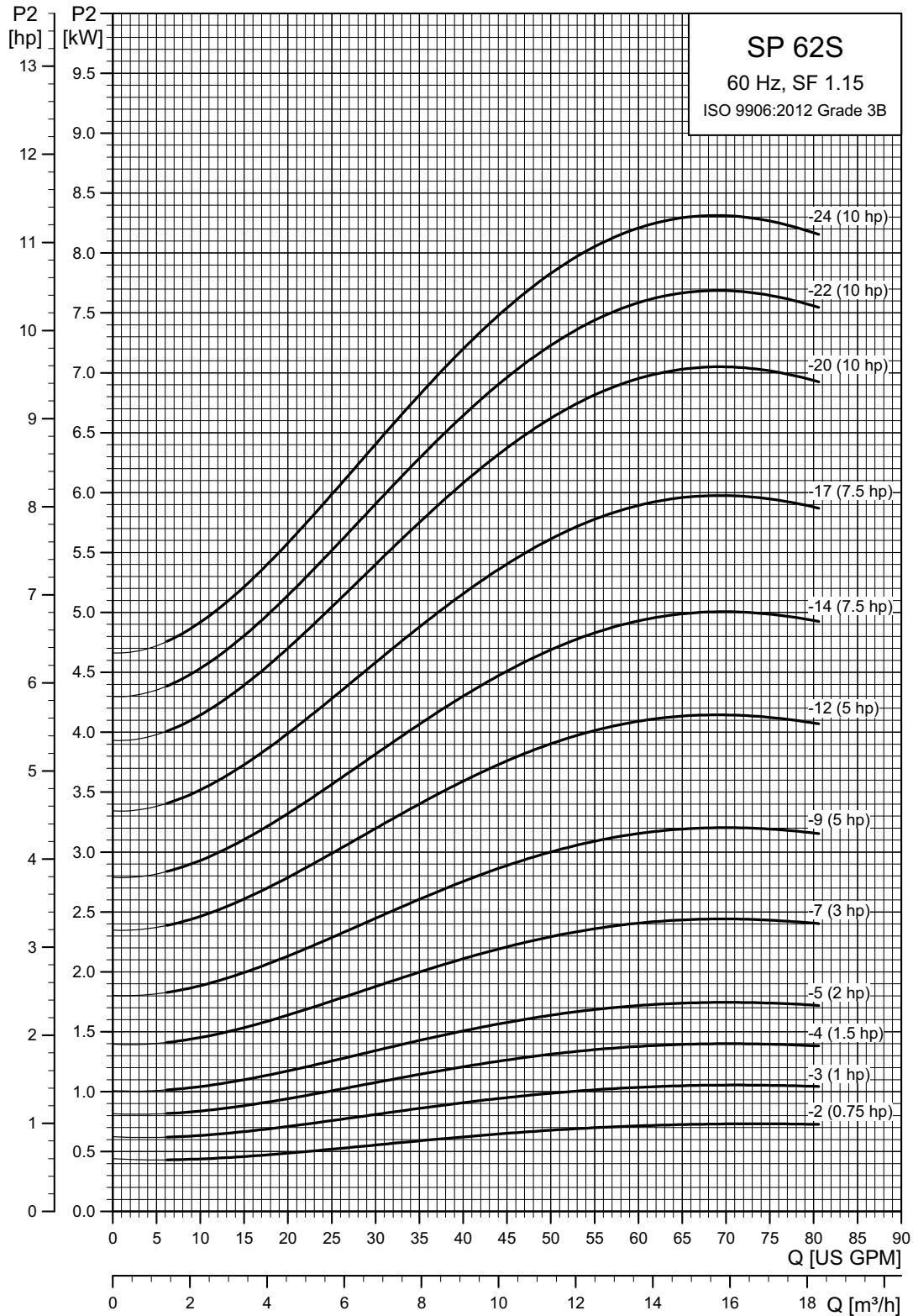

TM06 4619 3215

4" and larger wells - continued

SP 62S (62 gpm) / 4 inch motor

Pump model	Nom. head [ft]	Ph	Volts [V]	Motor [Hp]	Dimensions					Net weight (complete) [lb]	
					A [in. (mm)]	B [in. (mm)]	C [in. (mm)]	D [in. (mm)]	E [in. (mm)]		
62S - Motor dia. 4 inch, 3 wire motor, 60 Hz, rated 62 gpm (2" NPT)											
62S07-2	38	1	230	.75	■	28.35 (720)	13.08 (332)	15.28 (388)	3.75 (95)	3.98 (101)	29.7
		3	230	.75	■	26.97 (685)	11.70 (297)	15.28 (388)	3.75 (95)	3.98 (101)	26.7
		3	460	.75	■	26.97 (685)	11.70 (297)	15.28 (388)	3.75 (95)	3.98 (101)	26.7
		3	575	.75	■	26.97 (685)	11.70 (297)	15.28 (388)	3.75 (95)	3.98 (101)	26.7
62S10-3	58	1	230	1	■	31.89 (810)	13.67 (347)	18.23 (463)	3.75 (95)	3.98 (101)	33.0
		3	230	1	■	30.71 (780)	12.49 (317)	18.23 (463)	3.75 (95)	3.98 (101)	30.4
		3	460	1	■	30.71 (780)	12.49 (317)	18.23 (463)	3.75 (95)	3.98 (101)	30.2
		3	575	1	■	30.71 (780)	12.49 (317)	18.23 (463)	3.75 (95)	3.98 (101)	30.2
62S15-4	79	1	230	1.5	■	36.42 (925)	15.24 (387)	21.19 (538)	3.75 (95)	3.98 (101)	38.5
		3	230	1.5	■	34.85 (885)	13.67 (347)	21.19 (538)	3.75 (95)	3.98 (101)	35.0
		3	460	1.5	■	34.85 (885)	13.67 (347)	21.19 (538)	3.75 (95)	3.98 (101)	35.0
		3	575	1.5	■	34.85 (885)	13.67 (347)	21.19 (538)	3.75 (95)	3.98 (101)	34.8
62S20-5	100	1	230	2	●	43.71 (1110)	19.57 (497)	24.14 (613)	3.75 (95)	3.98 (101)	56.0
		3	230	2	■	39.38 (1000)	15.24 (387)	24.14 (613)	3.75 (95)	3.98 (101)	40.5
		3	460	2	■	39.38 (1000)	15.24 (387)	24.14 (613)	3.75 (95)	3.98 (101)	40.7
		3	575	2	■	39.38 (1000)	15.24 (387)	24.14 (613)	3.75 (95)	3.98 (101)	40.5
62S30-7	141	1	230	3	●	52.76 (1340)	22.72 (577)	30.04 (763)	3.75 (95)	3.98 (101)	68.3
		3	208-230	3	●	48.04 (1220)	18.00 (457)	30.04 (763)	3.75 (95)	3.98 (101)	55.1
		3	460	3	●	48.04 (1220)	18.00 (457)	30.04 (763)	3.75 (95)	3.98 (101)	55.1
62S50-9	182	1	230	5	●	62.60 (1590)	26.66 (677)	35.95 (913)	3.75 (95)	3.98 (101)	82.8
		3	208-230	5	●	58.67 (1490)	22.72 (577)	35.95 (913)	3.75 (95)	3.98 (101)	71.8
		3	460	5	●	58.67 (1490)	22.72 (577)	35.95 (913)	3.75 (95)	3.98 (101)	71.8
62S50-12	244	1	230	5	●	71.46 (1815)	26.66 (677)	44.81 (1138)	3.75 (95)	3.98 (101)	88.1
		3	208-230	5	●	67.52 (1715)	22.72 (577)	44.81 (1138)	3.75 (95)	3.98 (101)	77.1
		3	460	5	●	67.52 (1715)	22.72 (577)	44.81 (1138)	3.75 (95)	3.98 (101)	77.1
62S75-14	285	3	208-230	7.5	●	77.37 (1965)	26.66 (677)	50.71 (1288)	3.75 (95)	3.98 (101)	91.6
		3	460	7.5	●	77.37 (1965)	26.66 (677)	50.71 (1288)	3.75 (95)	3.98 (101)	91.6
		3	575	7.5	●	77.37 (1965)	26.66 (677)	50.71 (1288)	3.75 (95)	3.98 (101)	91.6
62S75-17	347	3	208-230	7.5	●	86.23 (2190)	26.66 (677)	59.57 (1513)	3.75 (95)	3.98 (101)	96.9
		3	460	7.5	●	86.23 (2190)	26.66 (677)	59.57 (1513)	3.75 (95)	3.98 (101)	96.9
		3	575	7.5	●	86.23 (2190)	26.66 (677)	59.57 (1513)	3.75 (95)	3.98 (101)	96.9
62S100-20	409	3	460	10	●	99.02 (2515)	30.60 (777)	68.43 (1738)	3.75 (95)	3.98 (101)	111.0
		3	575	10	●	99.02 (2515)	30.60 (777)	68.43 (1738)	3.75 (95)	3.98 (101)	111.0
62S100-22	450	3	460	10	●	104.93 (2665)	30.60 (777)	74.34 (1888)	3.75 (95)	3.98 (101)	114.5
		3	575	10	●	104.93 (2665)	30.60 (777)	74.34 (1888)	3.75 (95)	3.98 (101)	114.5
62S100-24	491	3	460	10	●	110.83 (2815)	30.60 (777)	80.24 (2038)	3.75 (95)	3.98 (101)	118.0
		3	575	10	●	110.83 (2815)	30.60 (777)	80.24 (2038)	3.75 (95)	3.98 (101)	118.0

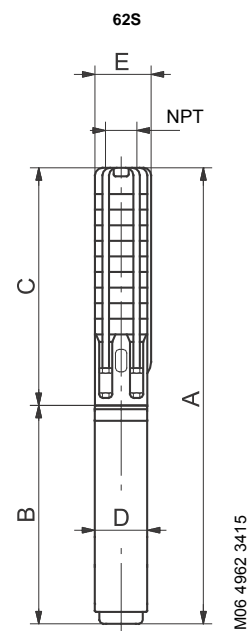

E = Maximum diameter of pump including cable guard and motor.

Notes:

Control box is required for 3-wire, single-phase applications. Data does not include control box. Performance conforms to ISO 9906: 1999 (E) Annex A. Minimum submergence is 2 feet.

- MS 402 motor.
- MS 4000 motor.

4" and larger wells - continued

SP 62S (62 gpm) / 6 inch motor

Pump model	Nom. head [ft]	Ph	Volts [V]	Motor [Hp]	Dimensions					Net weight (complete) [lb]
					A [in. (mm)]	B [in. (mm)]	C [in. (mm)]	D [in. (mm)]	E [in. (mm)]	
62S - Motor dia. 6 inch, 60 Hz, rated 62 gpm (2" NPT)										
62S75-14	285	3	208-230	7.5 ▲	76.70 (1948)	23.51 (597)	53.19 (1351)	5.50 (140)	5.50 (140)	119.3
		3	460	7.5 ▲	76.70 (1948)	23.51 (597)	53.19 (1351)	5.50 (140)	5.50 (140)	119.3
		3	575	7.5 ▲	76.70 (1948)	23.51 (597)	53.19 (1351)	5.50 (140)	5.50 (140)	119.3
62S75-17	347	3	208-230	7.5 ▲	85.56 (2173)	23.51 (597)	62.05 (1576)	5.50 (140)	5.50 (140)	124.6
		3	460	7.5 ▲	85.56 (2173)	23.51 (597)	62.05 (1576)	5.50 (140)	5.50 (140)	124.6
		3	575	7.5 ▲	85.56 (2173)	23.51 (597)	62.05 (1576)	5.50 (140)	5.50 (140)	124.6
62S100-20	409	3	208-230	10 ▲	95.60 (2428)	24.69 (627)	70.91 (1801)	5.50 (140)	5.50 (140)	136.4
		3	460	10 ▲	95.60 (2428)	24.69 (627)	70.91 (1801)	5.50 (140)	5.50 (140)	136.4
		3	575	10 ▲	95.60 (2428)	24.69 (627)	70.91 (1801)	5.50 (140)	5.50 (140)	136.4
62S100-22	450	3	208-230	10 ▲	101.50 (2578)	24.69 (627)	76.82 (1951)	5.50 (140)	5.50 (140)	139.9
		3	460	10 ▲	101.50 (2578)	24.69 (627)	76.82 (1951)	5.50 (140)	5.50 (140)	139.9
		3	575	10 ▲	101.50 (2578)	24.69 (627)	76.82 (1951)	5.50 (140)	5.50 (140)	139.9
62S100-24	491	3	208-230	10 ▲	107.41 (2728)	24.69 (627)	82.72 (2101)	5.50 (140)	5.50 (140)	143.4
		3	460	10 ▲	107.41 (2728)	24.69 (627)	82.72 (2101)	5.50 (140)	5.50 (140)	143.4
		3	575	10 ▲	107.41 (2728)	24.69 (627)	82.72 (2101)	5.50 (140)	5.50 (140)	143.4

Notes:

Control box is required for 3-wire, single-phase applications. Data does not include control box. Performance conforms to ISO 9906. 1999 (E) Annex A. Minimum submergence is 2 feet.

▲ MS 6000C motor.

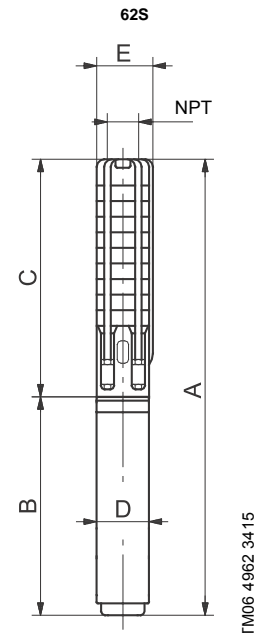

E = Maximum diameter of pump including cable guard and motor.

4" and larger wells - continued

SP 77S (77 gpm)

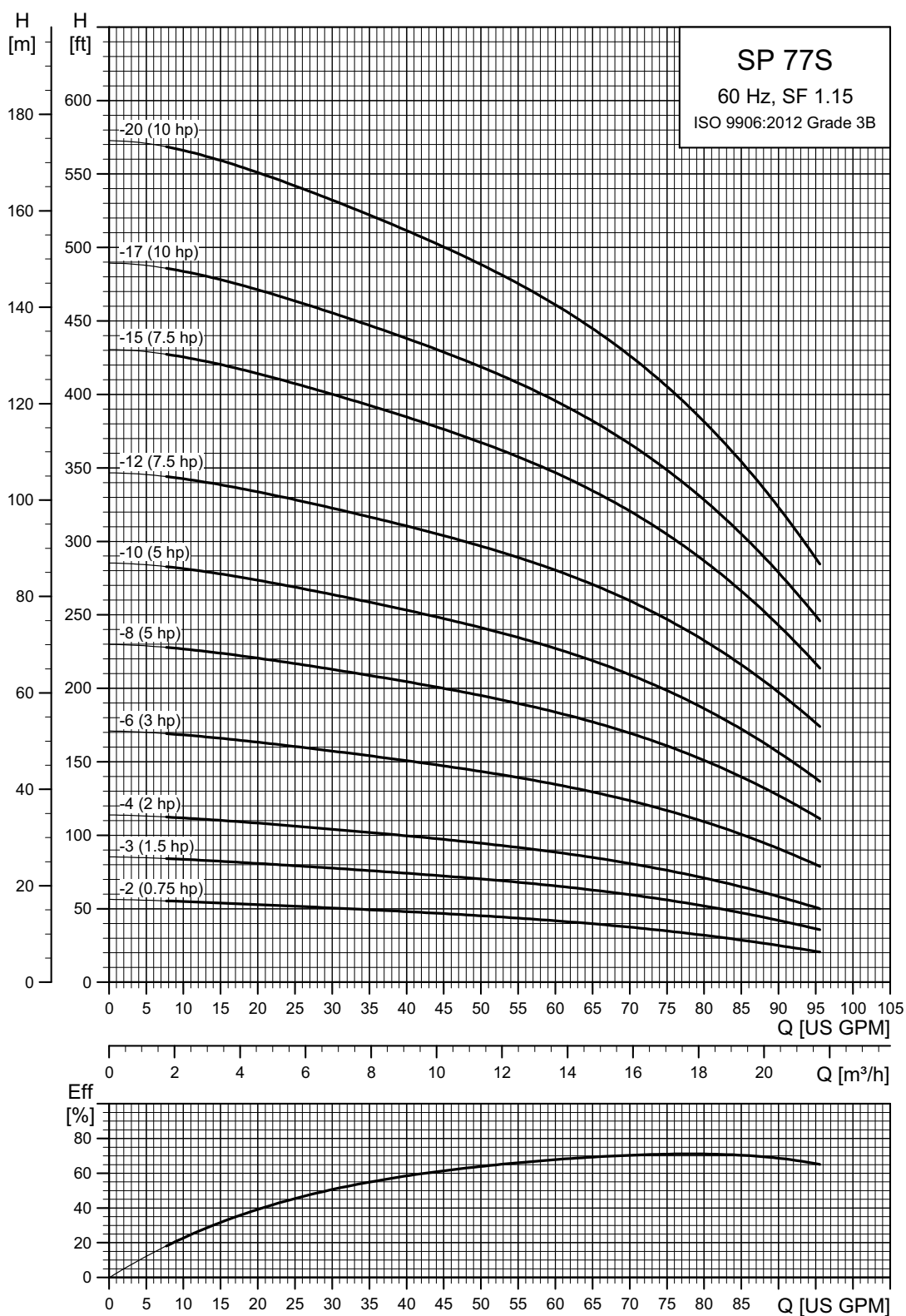

TM06 4620 3215

4" and larger pumps - continued

SP 77S (77 gpm) pump power requirement (P2)

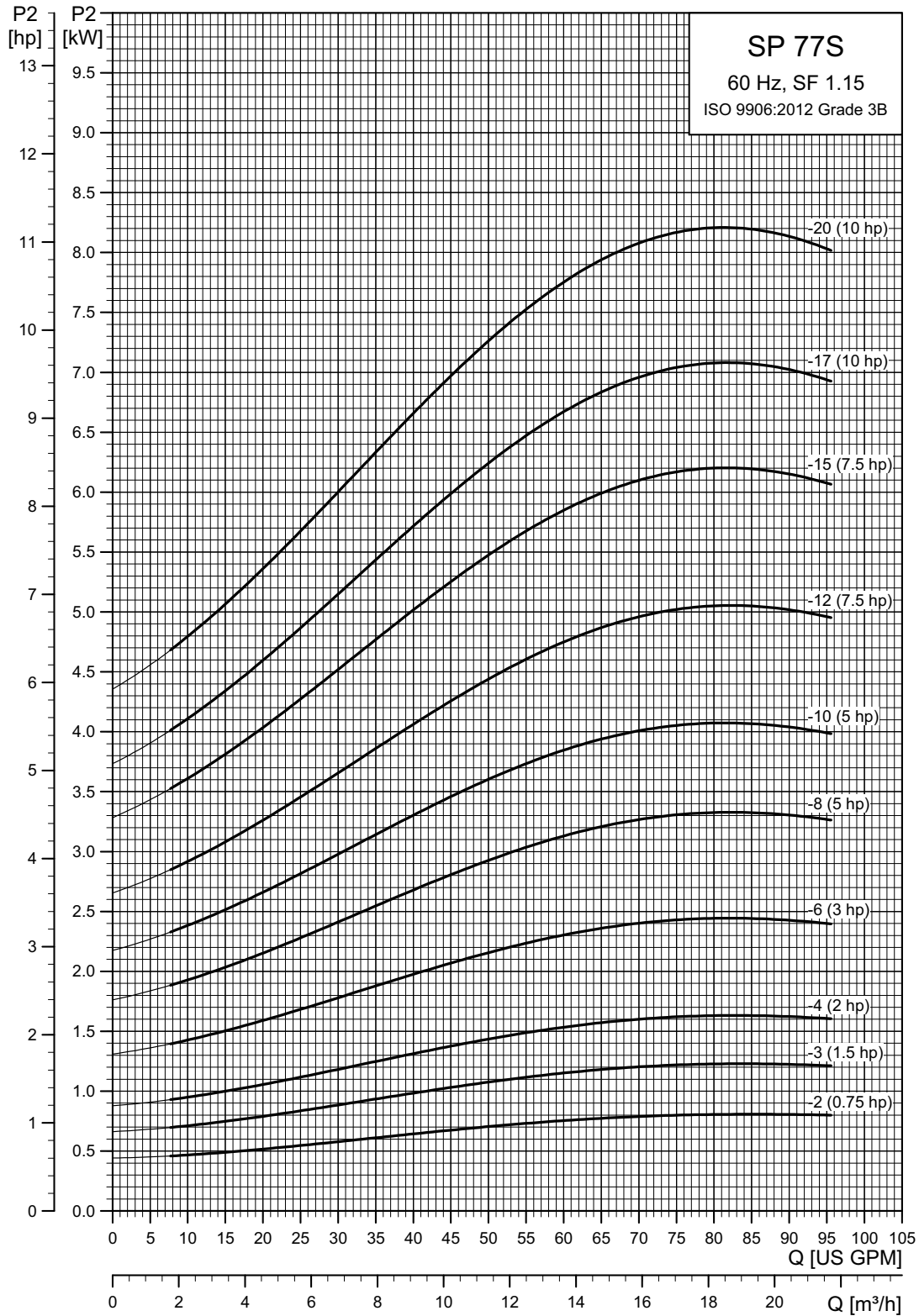

TM06 4621 3215

4" and larger wells - continued

SP 77S (77 gpm) / 4 inch motor

Pump model	Nom. head [ft]	Ph	Volts [V]	Motor [Hp]	Dimensions					Net weight (complete) [lb]	
					A [in. (mm)]	B [in. (mm)]	C [in. (mm)]	D [in. (mm)]	E [in. (mm)]		
77S - Motor dia. 4 inch, 3 wire motor, 60 Hz, rated 77 gpm (2" NPT)											
77S07-2	34	1	230	.75	■	28.35 (720)	13.08 (332)	15.28 (388)	3.75 (95)	3.98 (101)	29.7
		3	230	.75	■	26.97 (685)	11.70 (297)	15.28 (388)	3.75 (95)	3.98 (101)	26.7
		3	460	.75	■	26.97 (685)	11.70 (297)	15.28 (388)	3.75 (95)	3.98 (101)	26.7
		3	575	.75	■	26.97 (685)	11.70 (297)	15.28 (388)	3.75 (95)	3.98 (101)	26.7
77S15-3	53	1	230	1	■	33.47 (850)	15.24 (387)	18.23 (463)	3.75 (95)	3.98 (101)	36.8
		3	230	1.5	■	31.89 (810)	13.67 (347)	18.23 (463)	3.75 (95)	3.98 (101)	33.3
		3	460	1.5	■	31.89 (810)	13.67 (347)	18.23 (463)	3.75 (95)	3.98 (101)	33.3
		3	575	1.5	■	31.89 (810)	13.67 (347)	18.23 (463)	3.75 (95)	3.98 (101)	33.0
77S20-4	73	1	230	2	●	40.75 (1035)	19.57 (497)	21.19 (538)	3.75 (95)	3.98 (101)	54.2
		3	230	2	■	36.42 (925)	15.24 (387)	21.19 (538)	3.75 (95)	3.98 (101)	38.8
		3	460	2	■	36.42 (925)	15.24 (387)	21.19 (538)	3.75 (95)	3.98 (101)	39.0
		3	575	2	■	36.42 (925)	15.24 (387)	21.19 (538)	3.75 (95)	3.98 (101)	38.8
77S30-6	112	1	230	3	●	49.81 (1265)	22.72 (577)	27.09 (688)	3.75 (95)	3.98 (101)	66.5
		3	208-230	3	●	45.08 (1145)	18.00 (457)	27.09 (688)	3.75 (95)	3.98 (101)	53.3
		3	460	3	●	45.08 (1145)	18.00 (457)	27.09 (688)	3.75 (95)	3.98 (101)	53.3
77S50-8	152	1	230	5	●	59.65 (1515)	26.66 (677)	33.00 (838)	3.75 (95)	3.98 (101)	81.1
		3	208-230	5	●	55.71 (1415)	22.72 (577)	33.00 (838)	3.75 (95)	3.98 (101)	70.1
		3	460	5	●	55.71 (1415)	22.72 (577)	33.00 (838)	3.75 (95)	3.98 (101)	70.1
77S50-10	191	1	230	5	●	65.56 (1665)	26.66 (677)	38.90 (988)	3.75 (95)	3.98 (101)	84.6
		3	208-230	5	●	61.62 (1565)	22.72 (577)	38.90 (988)	3.75 (95)	3.98 (101)	73.6
		3	460	5	●	61.62 (1565)	22.72 (577)	38.90 (988)	3.75 (95)	3.98 (101)	73.6
77S75-12	230	3	208-230	7.5	●	71.46 (1815)	26.66 (677)	44.81 (1138)	3.75 (95)	3.98 (101)	88.1
		3	460	7.5	●	71.46 (1815)	26.66 (677)	44.81 (1138)	3.75 (95)	3.98 (101)	88.1
		3	575	7.5	●	71.46 (1815)	26.66 (677)	44.81 (1138)	3.75 (95)	3.98 (101)	88.1
77S75-15	289	3	208-230	7.5	●	80.32 (2040)	26.66 (677)	53.67 (1363)	3.75 (95)	3.98 (101)	93.4
		3	460	7.5	●	80.32 (2040)	26.66 (677)	53.67 (1363)	3.75 (95)	3.98 (101)	93.4
		3	575	7.5	●	80.32 (2040)	26.66 (677)	53.67 (1363)	3.75 (95)	3.98 (101)	93.4
77S100-17	329	3	460	10	●	90.16 (2290)	30.60 (777)	59.57 (1513)	3.75 (95)	3.98 (101)	105.7
		3	575	10	●	90.16 (2290)	30.60 (777)	59.57 (1513)	3.75 (95)	3.98 (101)	105.7
77S100-20	388	3	460	10	●	99.02 (2515)	30.60 (777)	68.43 (1738)	3.75 (95)	3.98 (101)	111.0
		3	575	10	●	99.02 (2515)	30.60 (777)	68.43 (1738)	3.75 (95)	3.98 (101)	111.0

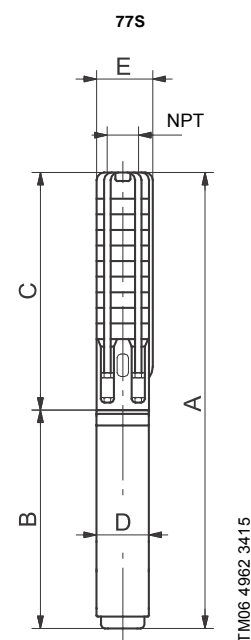

E = Maximum diameter of pump including cable guard and motor.

Notes:

Control box is required for 3-wire, single-phase applications. Data does not include control box. Performance conforms to ISO 9906: 1999 (E) Annex A. Minimum submergence is 2 feet.

- MS 402 motor.
- MS 4000 motor.

4" and larger wells - continued

SP 77S (77 gpm) / 6 inch motor

Pump model	Nom. head [ft]	Ph	Volts [V]	Motor [Hp]	Dimensions					Net weight (complete) [lb]
					A [in. (mm)]	B [in. (mm)]	C [in. (mm)]	D [in. (mm)]	E [in. (mm)]	
77S - Motor dia. 6 inch, 60 Hz, rated 77 gpm (2" NPT)										
77S75-12	230	3	208-230	.75 ▲	70.79 (1798)	23.51 (597)	47.29 (1201)	5.50 (140)	5.50 (140)	115.8
		3	460	.75 ▲	70.79 (1798)	23.51 (597)	47.29 (1201)	5.50 (140)	5.50 (140)	115.8
		3	575	.75 ▲	70.79 (1798)	23.51 (597)	47.29 (1201)	5.50 (140)	5.50 (140)	115.8
77S75-15	289	3	208-230	.75 ▲	79.65 (2023)	23.51 (597)	56.15 (1426)	5.50 (140)	5.50 (140)	121.1
		3	460	.75 ▲	79.65 (2023)	23.51 (597)	56.15 (1426)	5.50 (140)	5.50 (140)	121.1
		3	575	.75 ▲	79.65 (2023)	23.51 (597)	56.15 (1426)	5.50 (140)	5.50 (140)	121.1
77S100-17	329	3	208-230	10 ▲	86.74 (2203)	24.69 (627)	62.05 (1576)	5.50 (140)	5.50 (140)	131.2
		3	460	10 ▲	86.74 (2203)	24.69 (627)	62.05 (1576)	5.50 (140)	5.50 (140)	131.2
		3	575	10 ▲	86.74 (2203)	24.69 (627)	62.05 (1576)	5.50 (140)	5.50 (140)	131.2
77S100-20	388	3	208-230	10 ▲	95.60 (2428)	24.69 (627)	70.91 (1801)	5.50 (140)	5.50 (140)	136.4
		3	460	10 ▲	95.60 (2428)	24.69 (627)	70.91 (1801)	5.50 (140)	5.50 (140)	136.4
		3	575	10 ▲	95.60 (2428)	24.69 (627)	70.91 (1801)	5.50 (140)	5.50 (140)	136.4

Notes:

Control box is required for 3-wire, single-phase applications. Data does not include control box. Performance conforms to ISO 9906. 1999 (E) Annex A. Minimum submergence is 2 feet.

▲ MS 6000C motor.

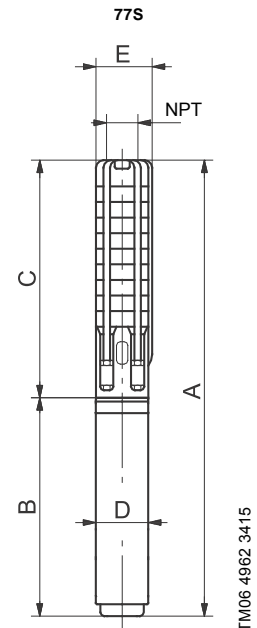

E = Maximum diameter of pump including cable guard and motor.

6" and larger wells SP 85S (85 gpm)

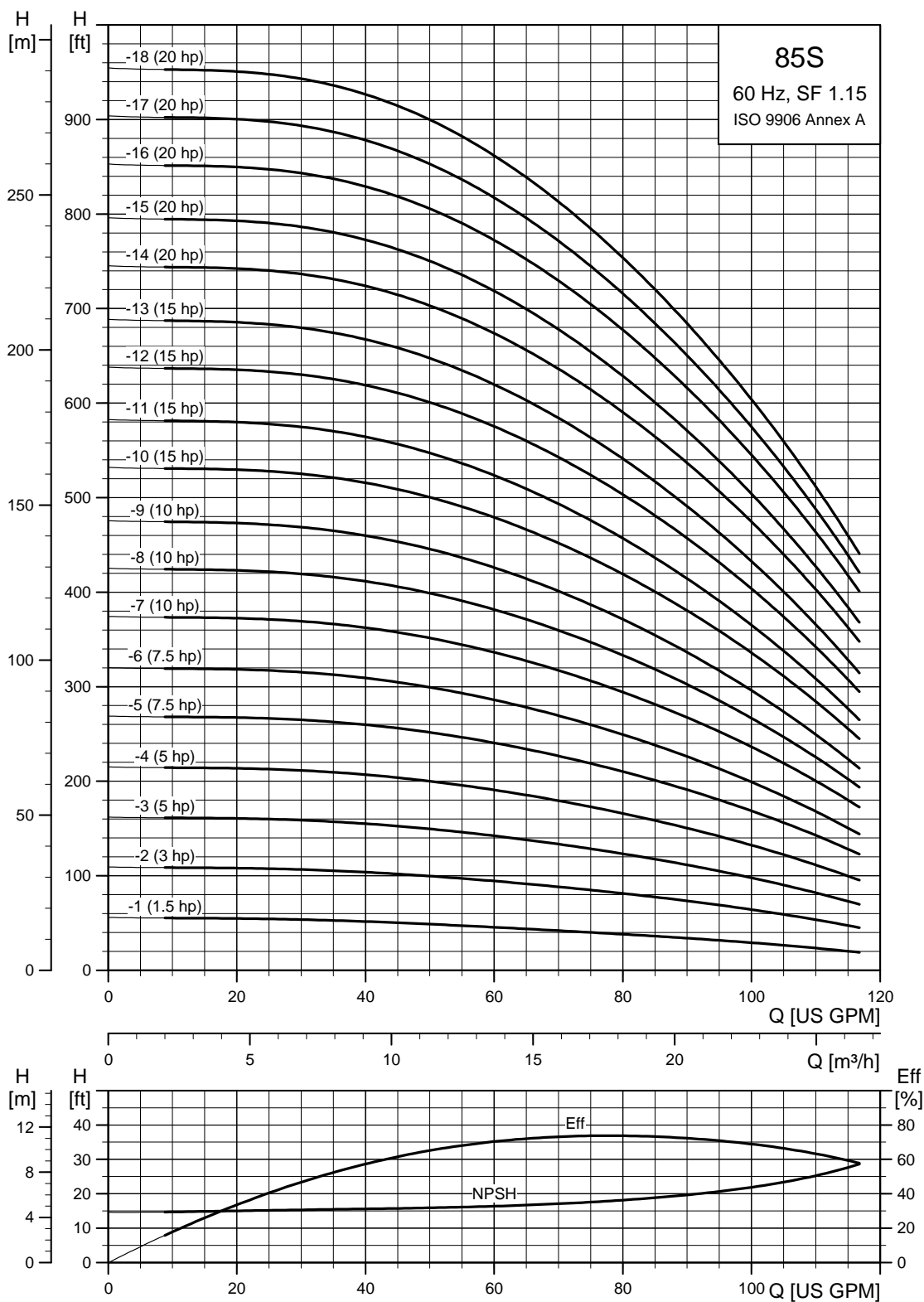

TM05 0235 1812

6" and larger wells - continued SP 85S (85 gpm)

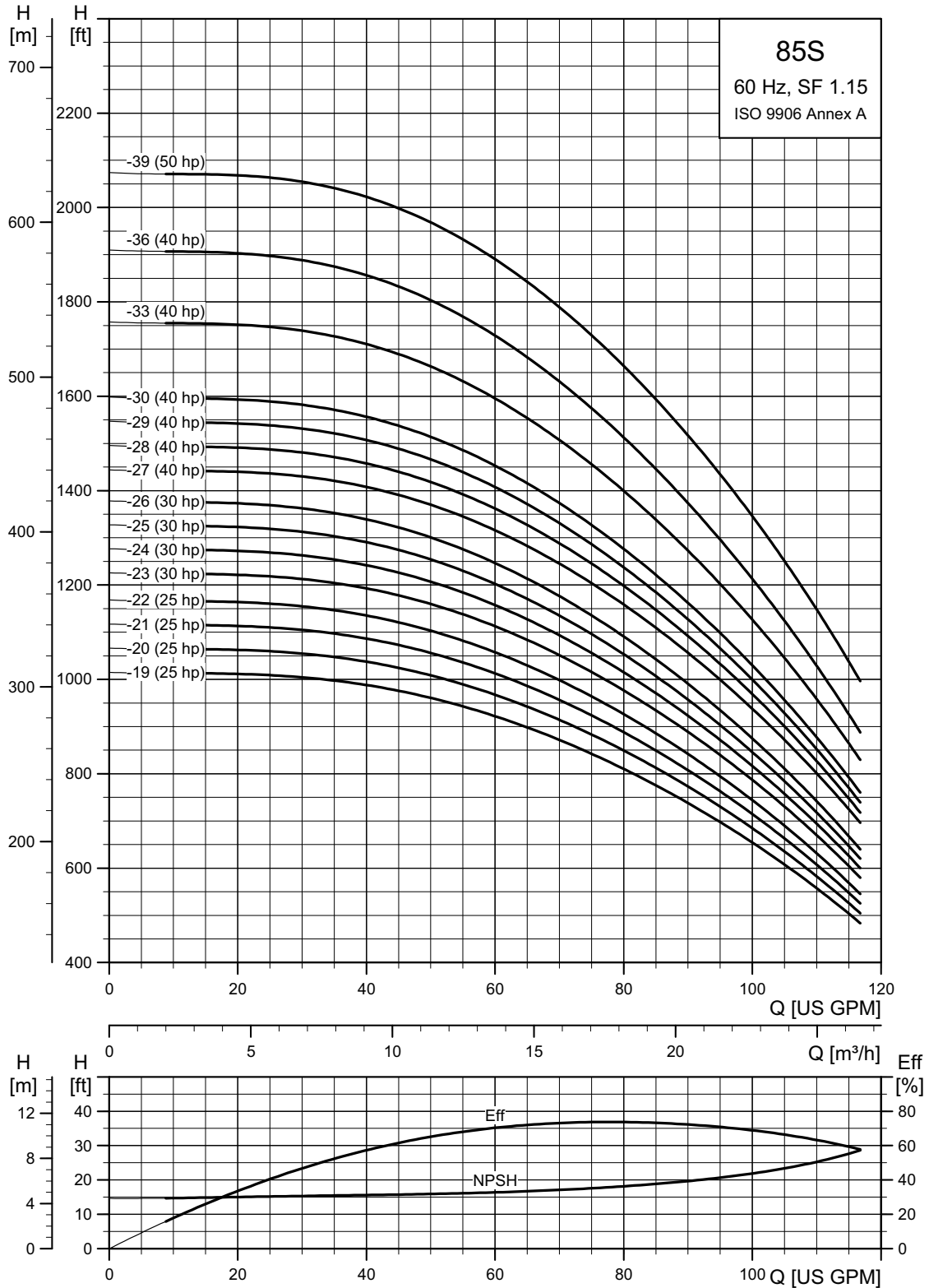

TM05 0236 3815

6" and larger wells - continued

SP 85S (85 gpm) pump power requirement (P2)

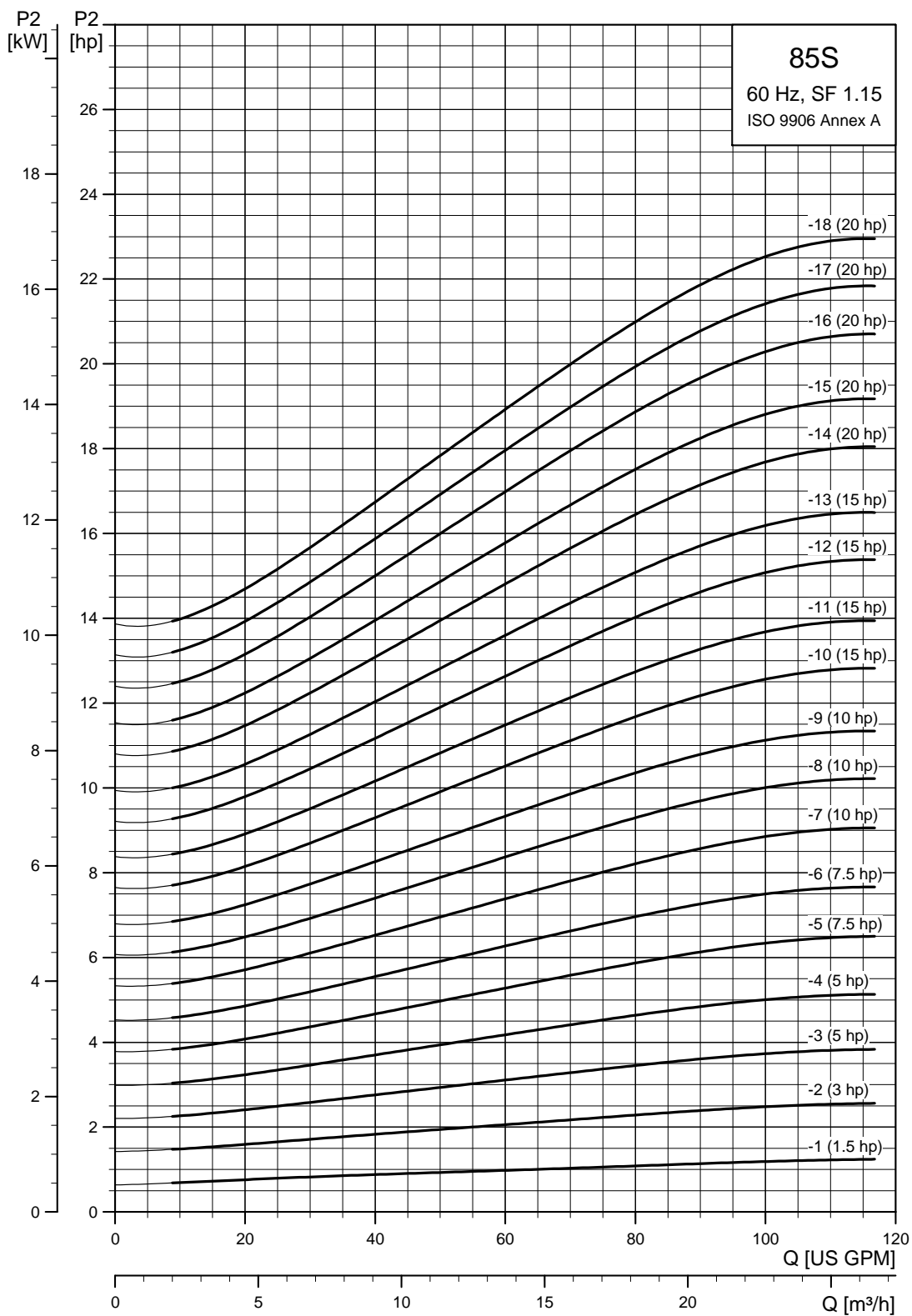

TM05 0237 1812

6" and larger wells - continued

SP 85S (85 gpm) pump power requirement (P2)

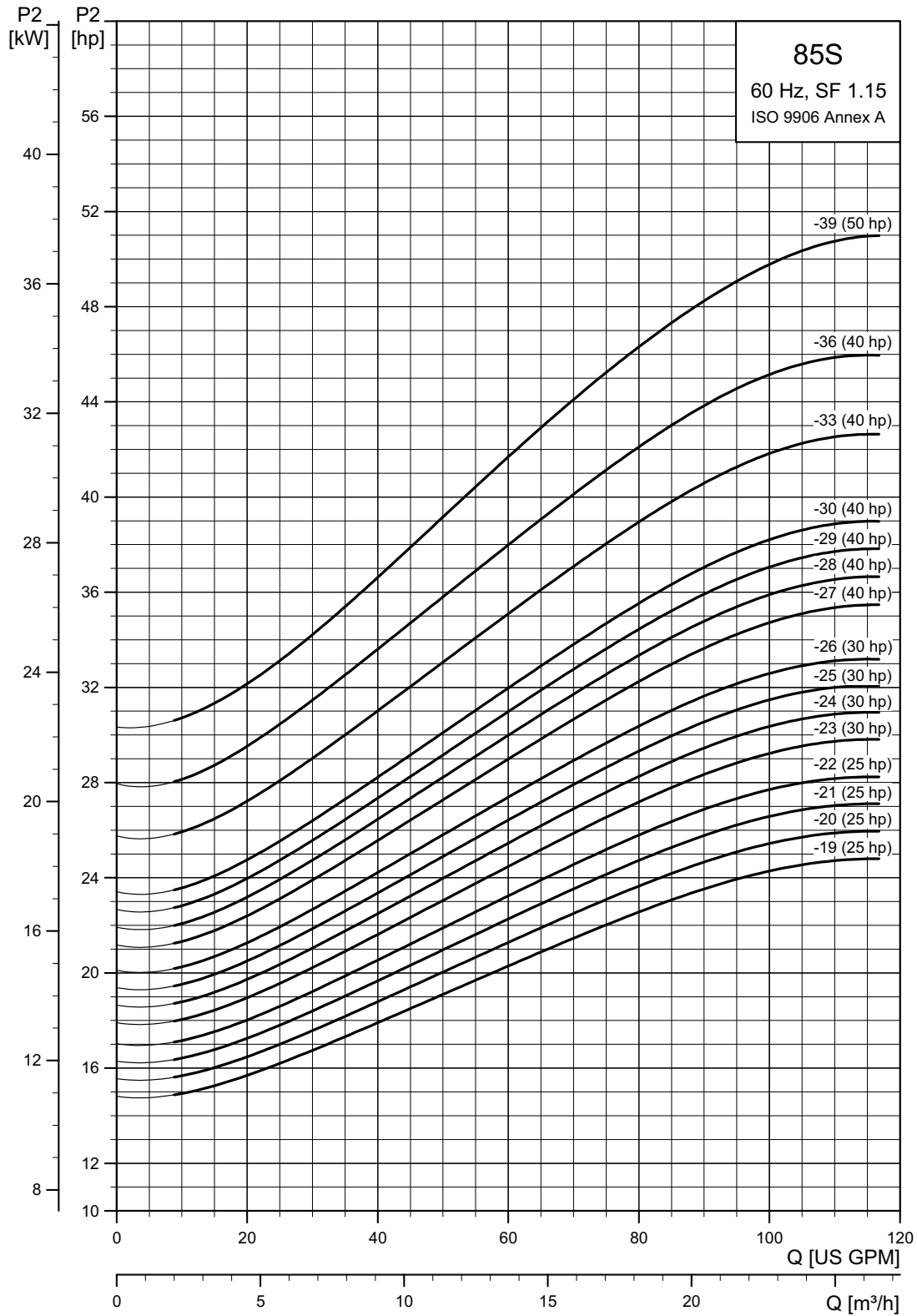

TM05 0238 3815

6" and larger wells - continued

SP 85S (85 gpm) / 4, 6 inch motors

Pump model	Nom. head [ft]	Ph	Volts [V]	Motor [Hp]	Dimensions					Net weight (complete) [lb (kg)]	
					A [in. (mm)]	B [in. (mm)]	C [in. (mm)]	D [in. (mm)]	E [in. (mm)]		
85S - Motor dia. 4 inch, 3 wire motor, 60 Hz, rated flow 85 gpm (3" NPT)											
85S15-1	35	1	230	1.5	■	28.04 (712)	15.24 (387)	12.80 (325)	3.75 (95)	5.28 (134)	29.7
		3	230	1.5	■	26.46 (672)	13.67 (347)	12.80 (325)	3.75 (95)	5.28 (134)	29.7
		3	460	1.5	■	26.46 (672)	13.67 (347)	12.80 (325)	3.75 (95)	5.28 (134)	29.7
85S30-2	74	1	230	3	●	37.88 (962)	22.72 (577)	15.16 (385)	3.75 (95)	5.28 (134)	55.8
		3	230	3	●	33.12 (841)	17.96 (456)	15.16 (385)	3.75 (95)	5.28 (134)	47.7
		3	460	3	●	33.12 (841)	17.96 (456)	15.16 (385)	3.75 (95)	5.28 (134)	47.7
85S50-3	114	1	230	5	●	44.22 (1123)	26.66 (677)	17.56 (446)	3.75 (95)	5.28 (134)	67.5
		3	230	5	●	40.24 (1022)	22.68 (576)	17.56 (446)	3.75 (95)	5.28 (134)	51.3
		3	460	5	●	40.24 (1022)	22.68 (576)	17.56 (446)	3.75 (95)	5.28 (134)	51.3
85S50-4	154	1	230	5	●	46.58 (1183)	26.66 (677)	19.93 (506)	3.75 (95)	5.28 (134)	69.3
		3	230	5	●	42.60 (1082)	22.68 (576)	19.93 (506)	3.75 (95)	5.28 (134)	61.2
		3	460	5	●	42.60 (1082)	22.68 (576)	19.93 (506)	3.75 (95)	5.28 (134)	61.2
85S75-5	194	3	230	7.5	●	48.94 (1243)	26.62 (676)	22.33 (567)	3.75 (95)	5.28 (134)	73.8
		3	460	7.5	●	48.94 (1243)	26.62 (676)	22.33 (567)	3.75 (95)	5.28 (134)	73.8
85S75-6	234	3	230	7.5	●	51.30 (1303)	26.62 (676)	24.69 (627)	3.75 (95)	5.28 (134)	85.5
		3	460	7.5	●	51.30 (1303)	26.62 (676)	24.69 (627)	3.75 (95)	5.28 (134)	76.5
85S100-7	274	3	460	10	●	57.64 (1464)	30.56 (776)	27.09 (688)	3.75 (95)	5.28 (134)	136.8
85S100-8	314	3	460	10	●	60.00 (1524)	30.56 (776)	29.45 (748)	3.75 (95)	5.28 (134)	138.6
85S100-9	353	3	460	10	●	62.41 (1585)	30.56 (776)	31.86 (809)	3.75 (95)	5.28 (134)	140.4
85S - Motor dia. 6 inch, 3 wire motor, 60 Hz, rated flow 85 gpm (3" NPT)											
85S75-5	194	3	230	7.5	▲	46.58 (1183)	23.51 (597)	23.08 (586)	5.52 (140)	5.52 (140)	98.1
		3	460	7.5	▲	46.58 (1183)	23.51 (597)	23.08 (586)	5.52 (140)	5.52 (140)	98.1
85S75-6	234	3	230	7.5	▲	48.94 (1243)	23.51 (597)	25.44 (646)	5.52 (140)	5.52 (140)	99.9
		3	460	7.5	▲	48.94 (1243)	23.51 (597)	25.44 (646)	5.52 (140)	5.52 (140)	99.9
85S100-7	274	3	230	10	▲	52.52 (1334)	24.69 (627)	27.84 (707)	5.52 (140)	5.52 (140)	103.5
		3	460	10	▲	52.52 (1334)	24.69 (627)	27.84 (707)	5.52 (140)	5.52 (140)	103.5
85S100-8	314	3	230	10	▲	54.89 (1394)	24.69 (627)	30.20 (767)	5.52 (140)	5.52 (140)	105.3
		3	460	10	▲	54.89 (1394)	24.69 (627)	30.20 (767)	5.52 (140)	5.52 (140)	105.3
85S100-9	353	3	230	10	▲	57.29 (1455)	24.69 (627)	32.60 (828)	5.52 (140)	5.52 (140)	108.0
		3	460	10	▲	57.29 (1455)	24.69 (627)	32.60 (828)	5.52 (140)	5.52 (140)	108.0
85S150-10	393	3	230	15	▲	62.01 (1575)	27.05 (687)	34.97 (888)	5.52 (140)	5.52 (140)	122.4
		3	460	15	▲	62.01 (1575)	27.05 (687)	34.97 (888)	5.52 (140)	5.52 (140)	122.4
85S150-11	433	3	230	15	▲	64.41 (1636)	27.05 (687)	37.37 (949)	5.52 (140)	5.52 (140)	126.0
		3	460	15	▲	64.41 (1636)	27.05 (687)	37.37 (949)	5.52 (140)	5.52 (140)	126.0
85S150-12	473	3	230	15	▲	66.78 (1696)	27.05 (687)	39.73 (1009)	5.52 (140)	5.52 (140)	133.2
		3	460	15	▲	66.78 (1696)	27.05 (687)	39.73 (1009)	5.52 (140)	5.52 (140)	133.2
85S150-13	513	3	230	15	▲	69.18 (1757)	27.05 (687)	42.13 (1070)	5.52 (140)	5.52 (140)	135.0
		3	460	15	▲	69.18 (1757)	27.05 (687)	42.13 (1070)	5.52 (140)	5.52 (140)	135.0

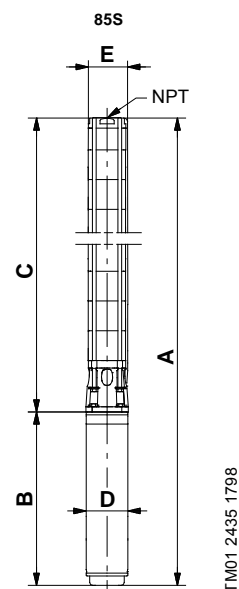

TM01 2435 1798

E = Maximum diameter of pump including cable guard and motor.

Notes:

Control box is required for 3-wire, single-phase applications. Data does not include control box. Performance conforms to ISO 9906. 1999 (E) Annex A. Minimum submergence is 2 feet.

- MS 402 motor.
- MS 4000 motor.
- ▲ MS 6000C motor.

6" and larger wells - continued

SP 85S (85 gpm) / 6, 8 inch motors

Pump model	Nom. head [ft]	Ph	Volts [V]	Motor [Hp]	Dimensions					Net weight (complete) [lb]	
					A [in. (mm)]	B [in. (mm)]	C [in. (mm)]	D [in. (mm)]	E [in. (mm)]		
85S - Motor dia. 6 inch, 60 Hz, rated flow 85 gpm (3" NPT)											
85S200-14	533	3	230	20	▲	74.10 (1882)	29.61 (752)	44.49 (1130)	5.52 (140)	5.52 (140)	143.1
		3	460	20	▲	74.10 (1882)	29.61 (752)	44.49 (1130)	5.52 (140)	5.52 (140)	143.1
85S200-15	593	3	230	20	▲	76.50 (1943)	29.61 (752)	46.89 (1191)	5.52 (140)	5.52 (140)	147.6
		3	460	20	▲	76.50 (1943)	29.61 (752)	46.89 (1191)	5.52 (140)	5.52 (140)	147.6
85S200-16	633	3	230	20	▲	78.86 (2003)	29.61 (752)	49.26 (1251)	5.52 (140)	5.52 (140)	157.5
		3	460	20	▲	78.86 (2003)	29.61 (752)	49.26 (1251)	5.52 (140)	5.52 (140)	157.5
85S200-17	672	3	230	20	▲	81.26 (2064)	29.61 (752)	51.66 (1312)	5.52 (140)	5.52 (140)	160.2
		3	460	20	▲	81.26 (2064)	29.61 (752)	51.66 (1312)	5.52 (140)	5.52 (140)	160.2
85S200-18	712	3	230	20	▲	83.63 (2124)	29.61 (752)	54.02 (1372)	5.52 (140)	5.52 (140)	161.1
		3	460	20	▲	83.63 (2124)	29.61 (752)	54.02 (1372)	5.52 (140)	5.52 (140)	179.0
85S250-19	752	3	230	25	▲	88.19 (2240)	31.78 (807)	56.42 (1433)	5.52 (140)	5.52 (140)	191.7
		3	460	25	▲	88.19 (2240)	31.78 (807)	56.42 (1433)	5.52 (140)	5.52 (140)	191.7
85S250-20	792	3	230	25	▲	90.56 (2300)	31.78 (807)	58.78 (1493)	5.52 (140)	5.52 (140)	195.3
		3	460	25	▲	90.56 (2300)	31.78 (807)	58.78 (1493)	5.52 (140)	5.52 (140)	195.3
85S250-21	832	3	230	25	▲	92.96 (2361)	31.78 (807)	61.19 (1554)	5.52 (140)	5.52 (140)	198.0
		3	460	25	▲	92.96 (2361)	31.78 (807)	61.19 (1554)	5.52 (140)	5.52 (140)	198.0
85S250-22	872	3	230	25	▲	95.32 (2421)	31.78 (807)	63.55 (1614)	5.52 (140)	5.52 (140)	199.8
		3	460	25	▲	95.32 (2421)	31.78 (807)	63.55 (1614)	5.52 (140)	5.52 (140)	199.8
85S300-23	912	3	230	30	▲	100.08 (2542)	34.14 (867)	65.95 (1675)	5.52 (140)	5.52 (140)	199.8
		3	460	30	▲	100.08 (2542)	34.14 (867)	65.95 (1675)	5.52 (140)	5.52 (140)	199.8
85S300-24	952	3	230	30	▲	102.45 (2602)	34.14 (867)	68.31 (1735)	5.52 (140)	5.52 (140)	216.0
		3	460	30	▲	102.45 (2602)	34.14 (867)	68.31 (1735)	5.52 (140)	5.52 (140)	216.0
85S300-25	991	3	230	30	▲	104.85 (2663)	34.14 (867)	70.71 (1796)	5.52 (140)	5.52 (140)	219.6
		3	460	30	▲	104.85 (2663)	34.14 (867)	70.71 (1796)	5.52 (140)	5.52 (140)	219.6
85S300-26	1031	3	230	30	▲	107.21 (2723)	34.14 (867)	73.08 (1856)	5.52 (140)	5.52 (140)	221.4
		3	460	30	▲	107.21 (2723)	34.14 (867)	73.08 (1856)	5.52 (140)	5.52 (140)	221.4
85S400-27	1071	3	460	40	▲	109.61 (2784)	34.14 (867)	75.48 (1917)	5.52 (140)	5.52 (140)	234.9
85S400-28	1111	3	460	40	▲	117.09 (2974)	39.26 (997)	77.84 (1977)	5.52 (140)	5.52 (140)	246.6
85S400-29	1151	3	460	40	▲	119.49 (3035)	39.26 (997)	80.24 (2038)	5.52 (140)	5.52 (140)	248.4
85S400-30	1191	3	460	40	▲	121.86 (3095)	39.26 (997)	82.60 (2098)	5.52 (140)	5.52 (140)	270.0
85S400-33DS	1310	3	460	40	▲	142.88 (3629)	39.26 (997)	103.63 (2632)	5.52 (140)	6.89 (175)	515.5
85S400-36DS	1430	3	460	40	▲	150.00 (3810)	39.26 (997)	110.75 (2813)	5.52 (140)	6.89 (175)	454.8
85S500-39DS	1510	3	460	50	▲	173.94 (4418)	56.03 (1423)	117.92 (2995)	5.63 (143)	6.89 (175)	469.0
85S - Motor dia. 8 inch, 60 Hz, rated flow 85 gpm (3" NPT)											
85S400-33DS	1310	3	460	40	★	145.12 (3686)	43.71 (1110)	101.42 (2576)	7.56 (192)	7.56 (192)	652.7
85S400-36DS	1310	3	460	40	★	152.25 (3867)	43.71 (1110)	108.55 (2757)	7.56 (192)	7.56 (192)	592.0
85S400-39DS	1510	3	460	50	★	159.41 (4049)	43.71 (1110)	115.71 (2939)	7.56 (192)	7.56 (192)	537.2

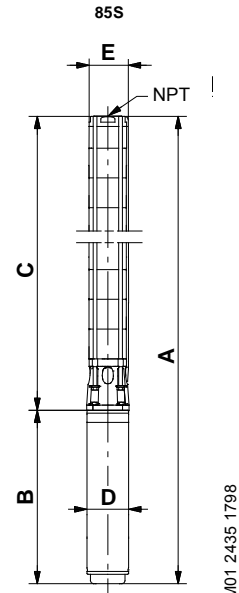

E = Maximum diameter of pump including cable guard and motor.

TM01 2435 1798

Notes:

Control box is required for 3-wire, single-phase applications. Data does not include control box.

DS designation = Built into sleeve, 1 - 1/2" NPT, 6" minimum well diameter.

Performance conforms to ISO 9906. 1999 (E) Annex A. Minimum submergence is 2 feet.

- ▲ MS 6000C motor.
- ★ MMS 8000 motor.

6" and larger wells - continued

SP 150S (150 gpm)

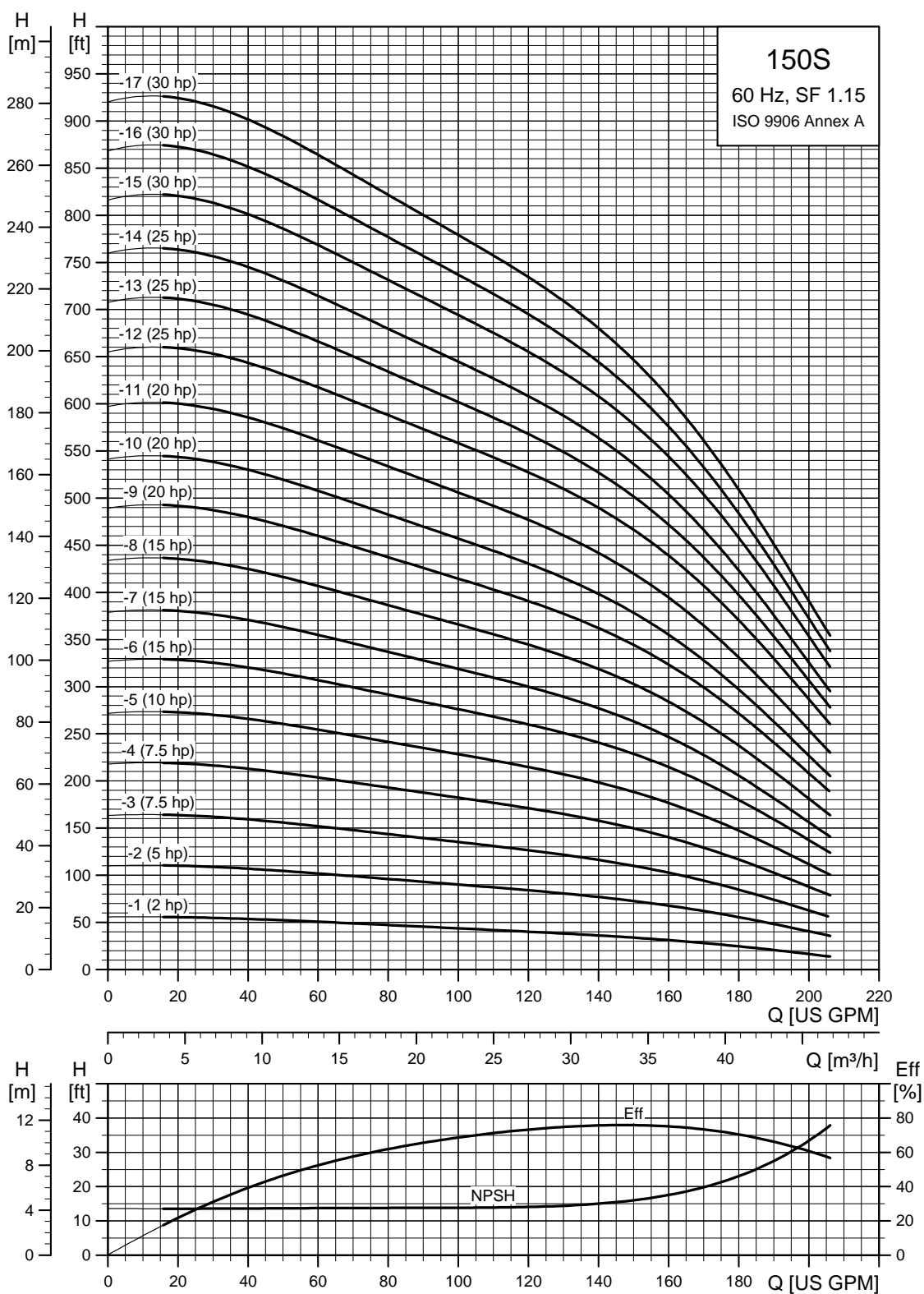

TM05 0239 1812

6" and larger wells - continued SP 150S (150 gpm)

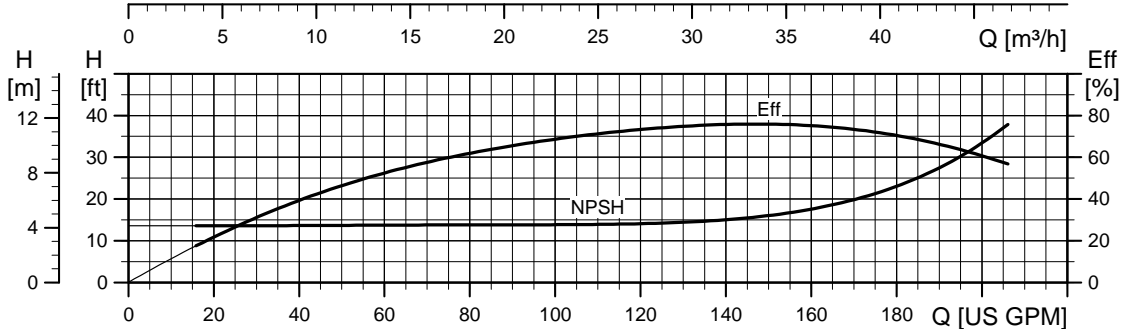
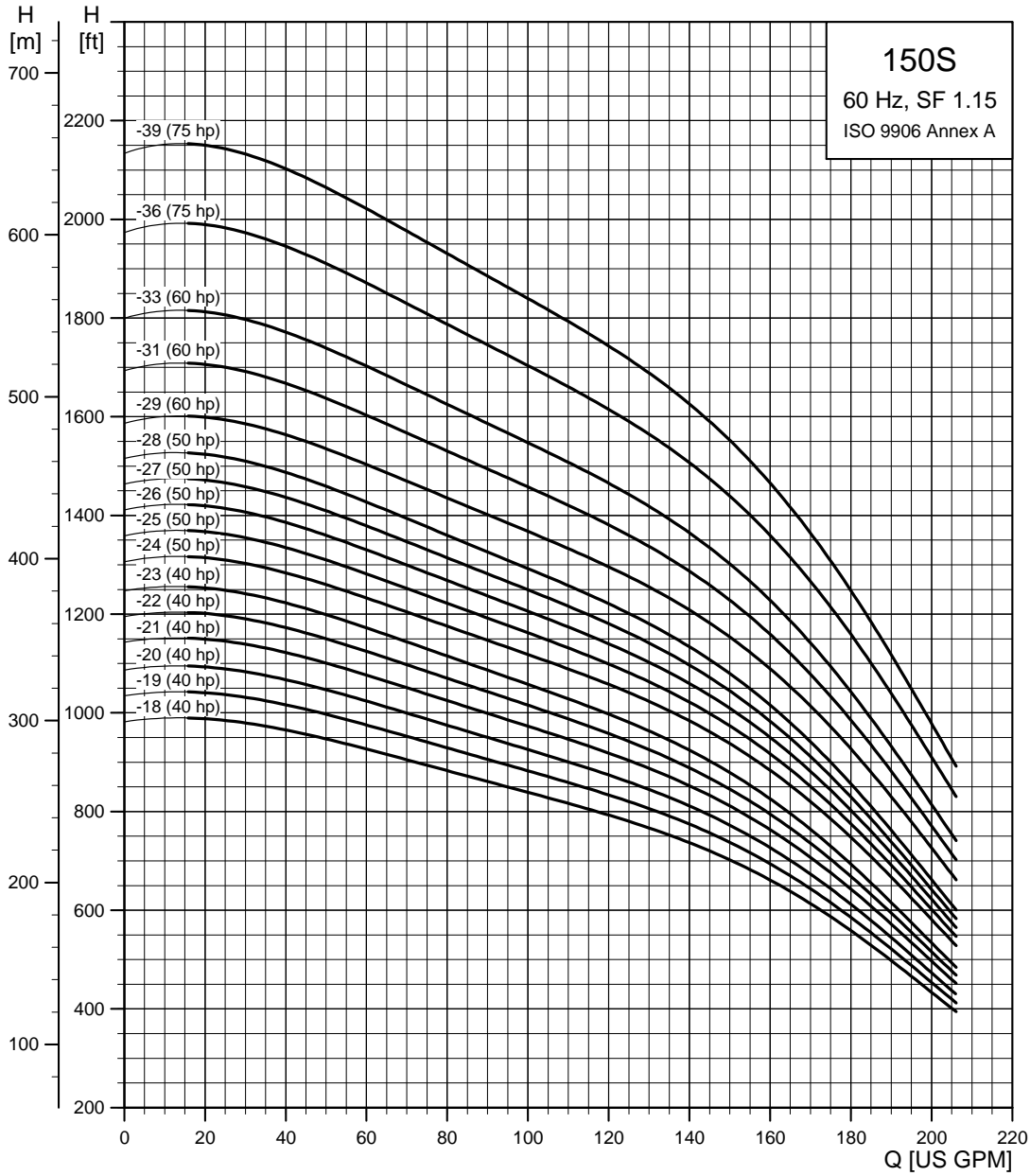

TM05 0240 1812

6" and larger wells - continued

SP 150S (150 gpm) pump power requirement (P2)

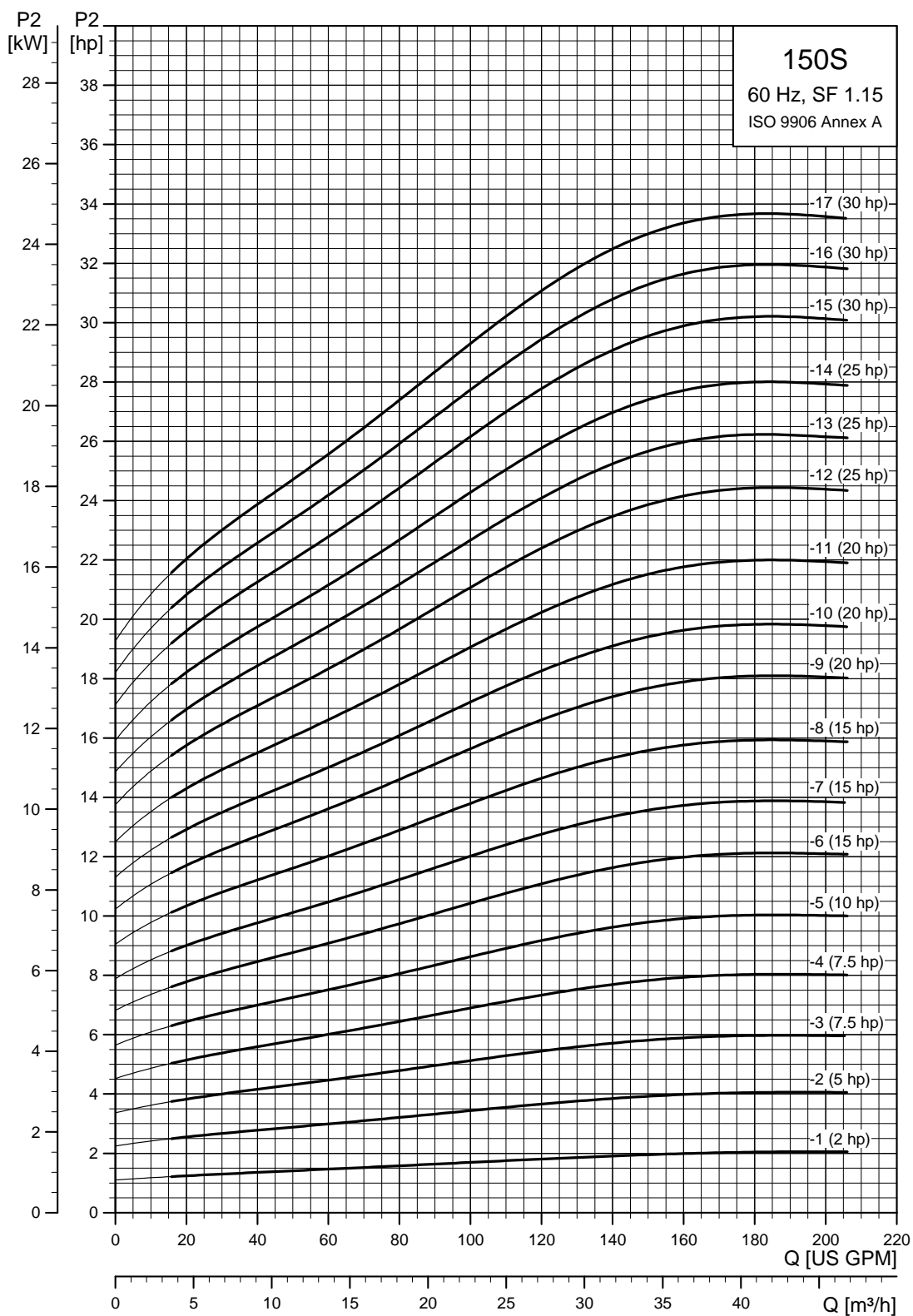

TM05 0241 1812

6" and larger wells - continued

SP 150S (150 gpm) pump power requirement (P2)

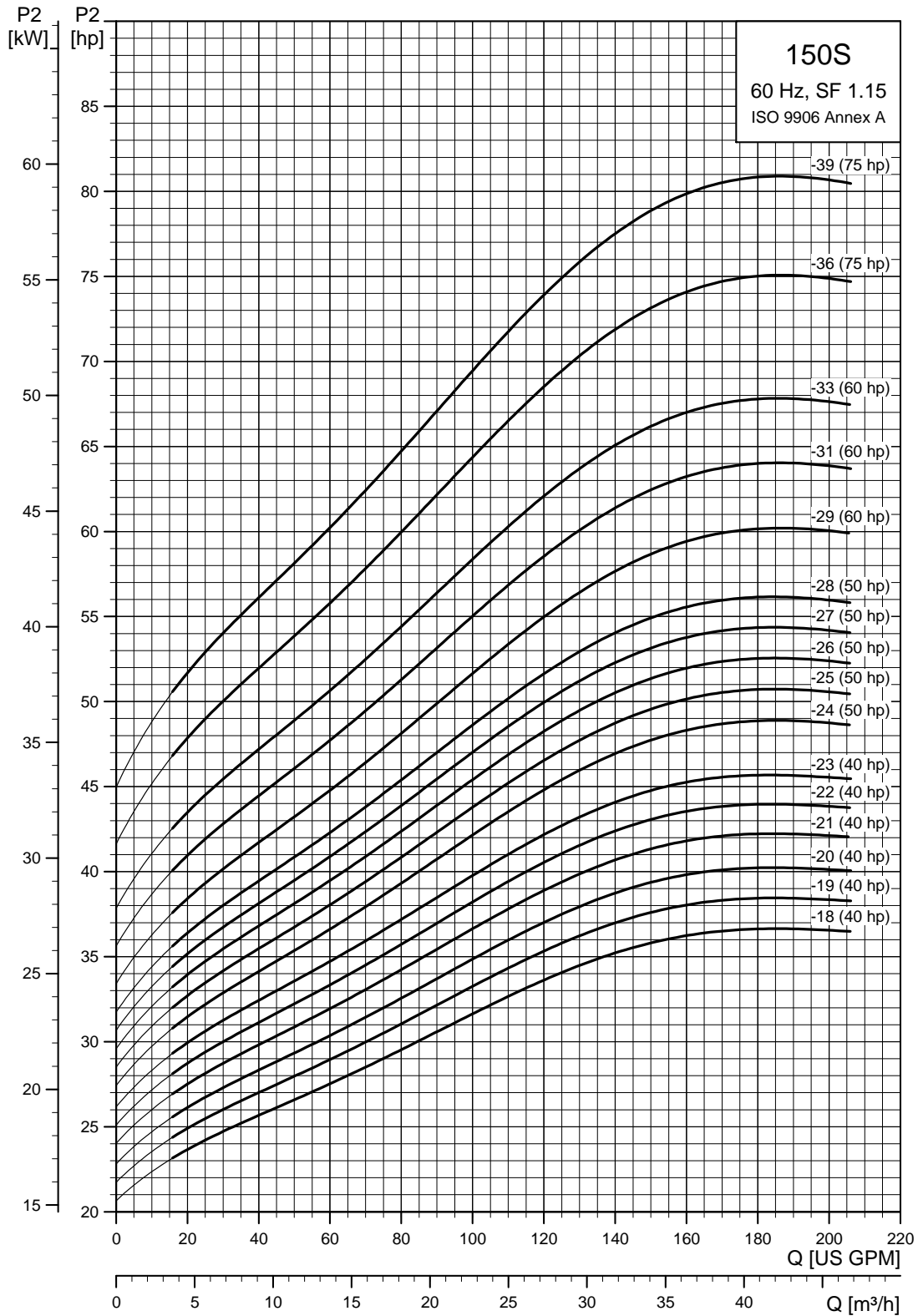

TM05 0242 1812

6" and larger wells - continued

SP 150S (150 gpm) / 4 inch motor

Pump model	Nom. head [ft]	Ph	Volts [V]	Motor [Hp]	Dimensions					Net weight (complete) [lb]	
					A [in. (mm)]	B [in. (mm)]	C [in. (mm)]	D [in. (mm)]	E [in. (mm)]		
150S - Motor dia. 4 inch, 3 wire motor, 60 Hz, rated flow 150 gpm (3" NPT)											
150S20-1	33	1	230	2	●	33.67 (855)	19.57 (497)	14.10 (358)	3.75 (95)	5.28 (134)	49.5
		3	230	2	■	29.34 (745)	15.24 (387)	14.10 (358)	3.75 (95)	5.28 (134)	45.0
		3	460	2	■	29.34 (745)	15.24 (387)	14.10 (358)	3.75 (95)	5.28 (134)	45.0
150S50-2	71	1	230	5	●	44.53 (1131)	26.66 (677)	17.88 (454)	3.75 (95)	5.28 (134)	67.5
		3	230	5	●	40.56 (1030)	22.68 (576)	17.88 (454)	3.75 (95)	5.28 (134)	42.3
		3	460	5	●	40.56 (1030)	22.68 (576)	17.88 (454)	3.75 (95)	5.28 (134)	42.3
150S75-3	108	3	230	7.5	●	48.27 (1226)	26.62 (676)	21.66 (550)	3.75 (95)	5.28 (134)	51.3
		3	460	7.5	●	48.27 (1226)	26.62 (676)	21.66 (550)	3.75 (95)	5.28 (134)	82.8
150S75-4	146	3	230	7.5	●	52.05 (1322)	26.62 (676)	25.44 (646)	3.75 (95)	5.28 (134)	85.5
		3	460	7.5	●	52.05 (1322)	26.62 (676)	25.44 (646)	3.75 (95)	5.28 (134)	85.5
150S100-5	184	3	460	10	●	59.77 (1518)	30.56 (776)	29.22 (742)	3.75 (95)	5.28 (134)	135.9
150S - Motor dia. 6 inch, 60 Hz, rated flow 150 gpm (3" NPT)											
150S75-4	146	3	230	7.5	▲	49.69 (1262)	23.51 (597)	26.19 (665)	5.52 (140)	5.52 (140)	99.9
		3	460	7.5	▲	49.69 (1262)	23.51 (597)	26.19 (665)	5.52 (140)	5.52 (140)	99.9
		3	230	10	▲	54.65 (1388)	24.69 (627)	29.97 (761)	5.52 (140)	5.52 (140)	73.8
150S100-5	184	3	460	10	▲	54.65 (1388)	24.69 (627)	29.97 (761)	5.52 (140)	5.52 (140)	73.8
		3	230	15	▲	60.79 (1544)	27.05 (687)	33.75 (857)	5.52 (140)	5.52 (140)	119.7
150S150-6	222	3	460	15	▲	60.79 (1544)	27.05 (687)	33.75 (857)	5.52 (140)	5.52 (140)	119.7
		3	230	15	▲	64.57 (1640)	27.05 (687)	37.52 (953)	5.52 (140)	5.52 (140)	127.8
150S150-7	260	3	460	15	▲	64.57 (1640)	27.05 (687)	37.52 (953)	5.52 (140)	5.52 (140)	127.8
		3	230	15	▲	68.35 (1736)	27.05 (687)	41.30 (1049)	5.52 (140)	5.52 (140)	137.7
150S150-8	297	3	460	15	▲	68.35 (1736)	27.05 (687)	41.30 (1049)	5.52 (140)	5.52 (140)	137.7
		3	230	20	▲	74.69 (1897)	29.61 (752)	45.08 (1145)	5.52 (140)	5.52 (140)	141.3
150S200-9	335	3	460	20	▲	74.69 (1897)	29.61 (752)	45.08 (1145)	5.52 (140)	5.52 (140)	141.3
		3	230	20	▲	78.47 (1993)	29.61 (752)	48.86 (1241)	5.52 (140)	5.52 (140)	151.2
150S200-10	373	3	460	20	▲	78.47 (1993)	29.61 (752)	48.86 (1241)	5.52 (140)	5.52 (140)	151.2
		3	230	20	▲	82.25 (2089)	29.61 (752)	52.64 (1337)	5.52 (140)	5.52 (140)	166.5
150S200-11	411	3	460	20	▲	82.25 (2089)	29.61 (752)	52.64 (1337)	5.52 (140)	5.52 (140)	166.5
		3	230	25	▲	88.19 (2240)	31.78 (807)	56.42 (1433)	5.52 (140)	5.52 (140)	188.1
150S250-12	448	3	460	25	▲	88.19 (2240)	31.78 (807)	56.42 (1433)	5.52 (140)	5.52 (140)	188.1
		3	230	25	▲	91.97 (2336)	31.78 (807)	60.20 (1529)	5.52 (140)	5.52 (140)	201.6
150S250-13	486	3	460	25	▲	91.97 (2336)	31.78 (807)	60.20 (1529)	5.52 (140)	5.52 (140)	201.6
		3	230	25	▲	95.75 (2432)	31.78 (807)	63.98 (1625)	5.52 (140)	5.52 (140)	206.1
150S250-14	524	3	460	25	▲	95.75 (2432)	31.78 (807)	63.98 (1625)	5.52 (140)	5.52 (140)	206.1

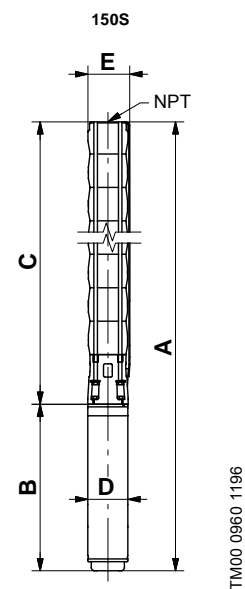

E = Maximum diameter of pump including cable guard and motor.

TM00 0960 1196

Notes:

Control box is required for 3-wire, single-phase applications. Data does not include control box. Performance conforms to ISO 9906: 1999 (E) Annex A. Minimum submergence is 2 feet.

- MS 402 motor.
- MS 4000 motor.
- ▲ MS 6000C motor.

6" and larger wells - continued

SP 150S (150 gpm) / 6, 8 inch motor

Pump model	Nom. head [ft]	Ph	Volts [V]	Motor [Hp]	Dimensions					Net weight (complete) [lb]
					A [in. (mm)]	B [in. (mm)]	C [in. (mm)]	D [in. (mm)]	E [in. (mm)]	
150S - Motor dia. 6 inch, 60 Hz, rated flow 150 gpm (3" NPT)										
150S300-15	562	3	230	30	▲ 101.89 (2588)	34.14 (867)	67.76 (1721)	5.52 (140)	5.52 (140)	209.7
		3	460	30	▲ 101.89 (2588)	34.14 (867)	67.76 (1721)	5.52 (140)	5.52 (140)	209.7
150S300-16	600	3	230	30	▲ 105.67 (2684)	34.14 (867)	71.54 (1817)	5.52 (140)	5.52 (140)	211.5
		3	460	30	▲ 105.67 (2684)	34.14 (867)	71.54 (1817)	5.52 (140)	5.52 (140)	211.5
150S300-17	637	3	230	30	▲ 109.45 (2780)	34.14 (867)	75.32 (1913)	5.52 (140)	5.52 (140)	216.0
		3	460	30	▲ 109.45 (2780)	34.14 (867)	75.32 (1913)	5.52 (140)	5.52 (140)	246.6
150S400-18	675	3	460	40	▲ 118.35 (3006)	39.26 (997)	79.10 (2009)	5.52 (140)	5.52 (140)	246.6
150S400-19	713	3	460	40	▲ 122.13 (3102)	39.26 (997)	82.88 (2105)	5.52 (140)	5.52 (140)	248.4
150S400-20	751	3	460	40	▲ 125.91 (3198)	39.26 (997)	86.66 (2201)	5.52 (140)	5.52 (140)	291.0
150S400-21	789	3	460	40	▲ 129.69 (3294)	39.26 (997)	90.44 (2297)	5.52 (140)	5.52 (140)	271.8
150S400-22	826	3	460	40	▲ 133.47 (3390)	39.26 (997)	94.22 (2393)	5.52 (140)	5.52 (140)	305.9
150S400-23	864	3	460	40	▲ 137.25 (3486)	39.26 (997)	98.00 (2489)	5.52 (140)	5.52 (140)	277.2
150S500-24	902	3	460	50	☼ 157.88 (4010)	56.11 (1425)	101.78 (2585)	5.67 (144)	5.67 (144)	411.8
150S500-25	940	3	460	50	☼ 161.66 (4106)	56.11 (1425)	105.56 (2681)	5.67 (144)	5.67 (144)	419.0
150S500-26	977	3	460	50	☼ 165.44 (4202)	56.11 (1425)	109.34 (2777)	5.67 (144)	5.67 (144)	426.2
150S500-27	1015	3	460	50	☼ 169.22 (4298)	56.11 (1425)	113.12 (2873)	5.67 (144)	5.67 (144)	433.4
150S500-28	1053	3	460	50	☼ 173.00 (4394)	56.11 (1425)	116.89 (2969)	5.67 (144)	5.67 (144)	440.6
150S600-29DS	1091	3	460	60	-	-	134.53 (3417)	-	6.89 (175)	-
150S600-31DS	1166	3	460	60	-	-	142.09 (3609)	-	6.89 (175)	-
150S600-33DS	1242	3	460	60	-	-	149.65 (3801)	-	6.89 (175)	-
150S - Motor dia. 8 inch, 60 Hz, rated flow 150 gpm (3" NPT)										
150S500-24	902	3	460	50	* 162.45 (4126)	45.67 (1160)	116.78 (2966)	7.56 (192)	7.56 (192)	484.5
150S500-25	940	3	460	50	* 166.23 (4222)	45.67 (1160)	120.56 (3062)	7.56 (192)	7.56 (192)	491.7
150S500-26	977	3	460	50	* 170.00 (4318)	45.67 (1160)	124.34 (3158)	7.56 (192)	7.56 (192)	498.9
150S500-27	1015	3	460	50	* 173.78 (4414)	45.67 (1160)	128.12 (3254)	7.56 (192)	7.56 (192)	506.1
150S500-28	1053	3	460	50	* 177.56 (4510)	45.67 (1160)	131.89 (3350)	7.56 (192)	7.56 (192)	513.3
150S600-29DS	1091	3	460	60	* 182.33 (4631)	50.00 (1270)	132.33 (3361)	7.56 (192)	7.56 (192)	612.7
150S600-31DS	1166	3	460	60	* 189.89 (4823)	50.00 (1270)	139.89 (3553)	7.56 (192)	7.56 (192)	623.7
150S600-33DS	1242	3	460	60	* 197.45 (5015)	50.00 (1270)	147.45 (3745)	7.56 (192)	7.56 (192)	639.1
150S750-36DS	1355	3	460	75	* 211.93 (5383)	53.15 (1350)	158.78 (4033)	7.56 (192)	7.56 (192)	689.2
150S750-39DS	1469	3	460	75	* 223.27 (5671)	53.15 (1350)	170.12 (4321)	7.56 (192)	7.56 (192)	704.6

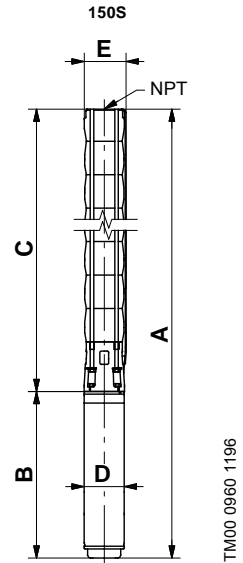

E = Maximum diameter of pump including cable guard and motor.

TM00 0960 1196

Notes:

Control box is required for 3-wire, single-phase applications. Data does not include control box.

DS designation = Built into sleeve, 1 - 1/2" NPT, 6" minimum well diameter.

Performance conforms to ISO 9906. 1999 (E) Annex A. Minimum submergence is 2 feet.

- ▲ MS 6000C motor.
- ☼ Takes MMS 6 motor; not available as complete.
- * Takes MMS 8000 motor; not available as complete.

6" and larger wells - continued SP 230S (230 gpm)

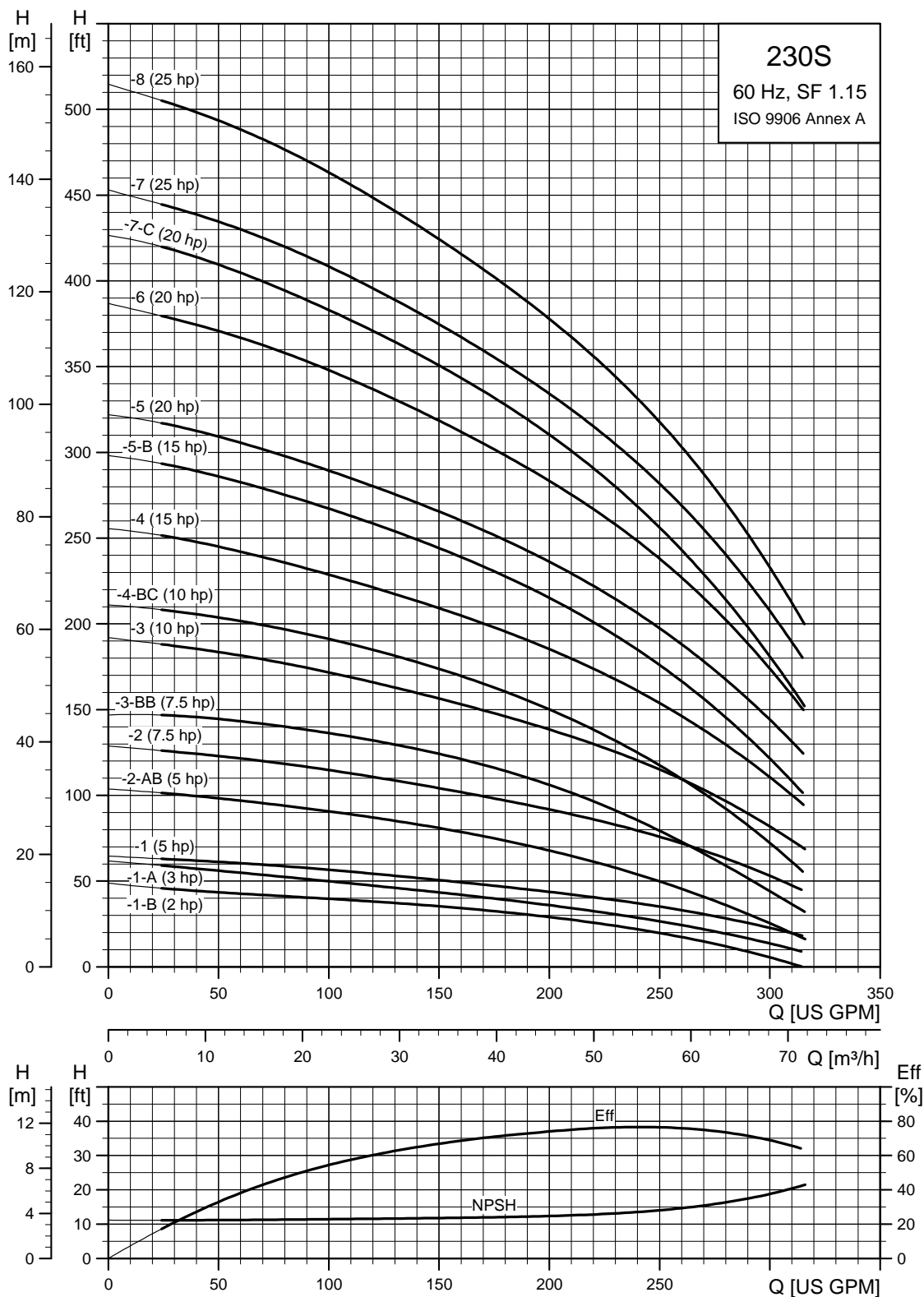

TM05 0243 1812

6" and larger wells - continued SP 230S (230 gpm)

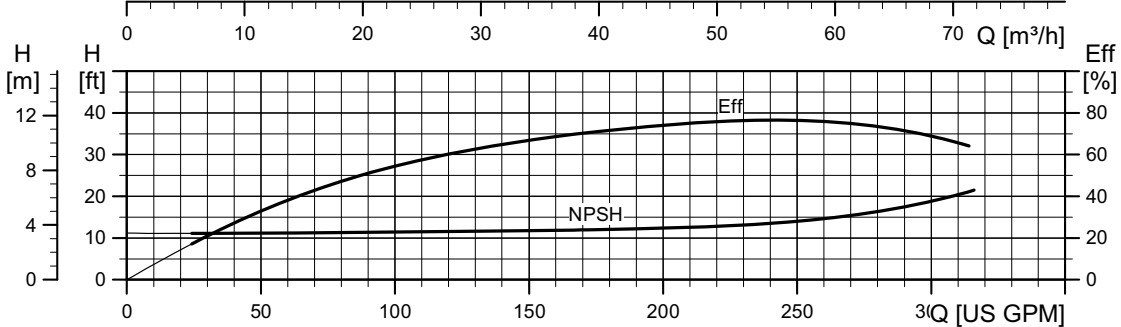
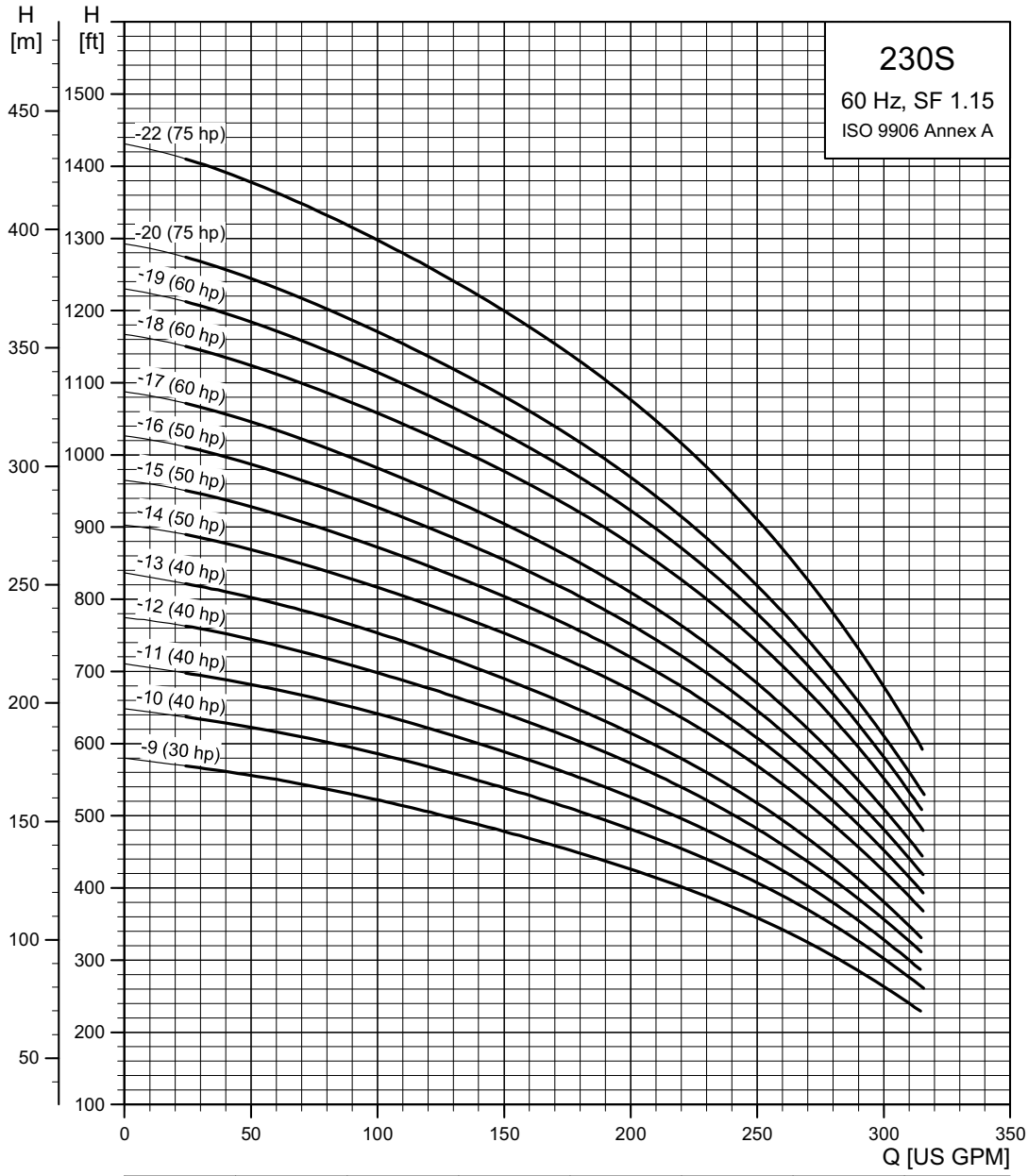

TM05 0244 5014

6" and larger wells - continued

SP 230S (230 gpm) pump power requirement (P2)

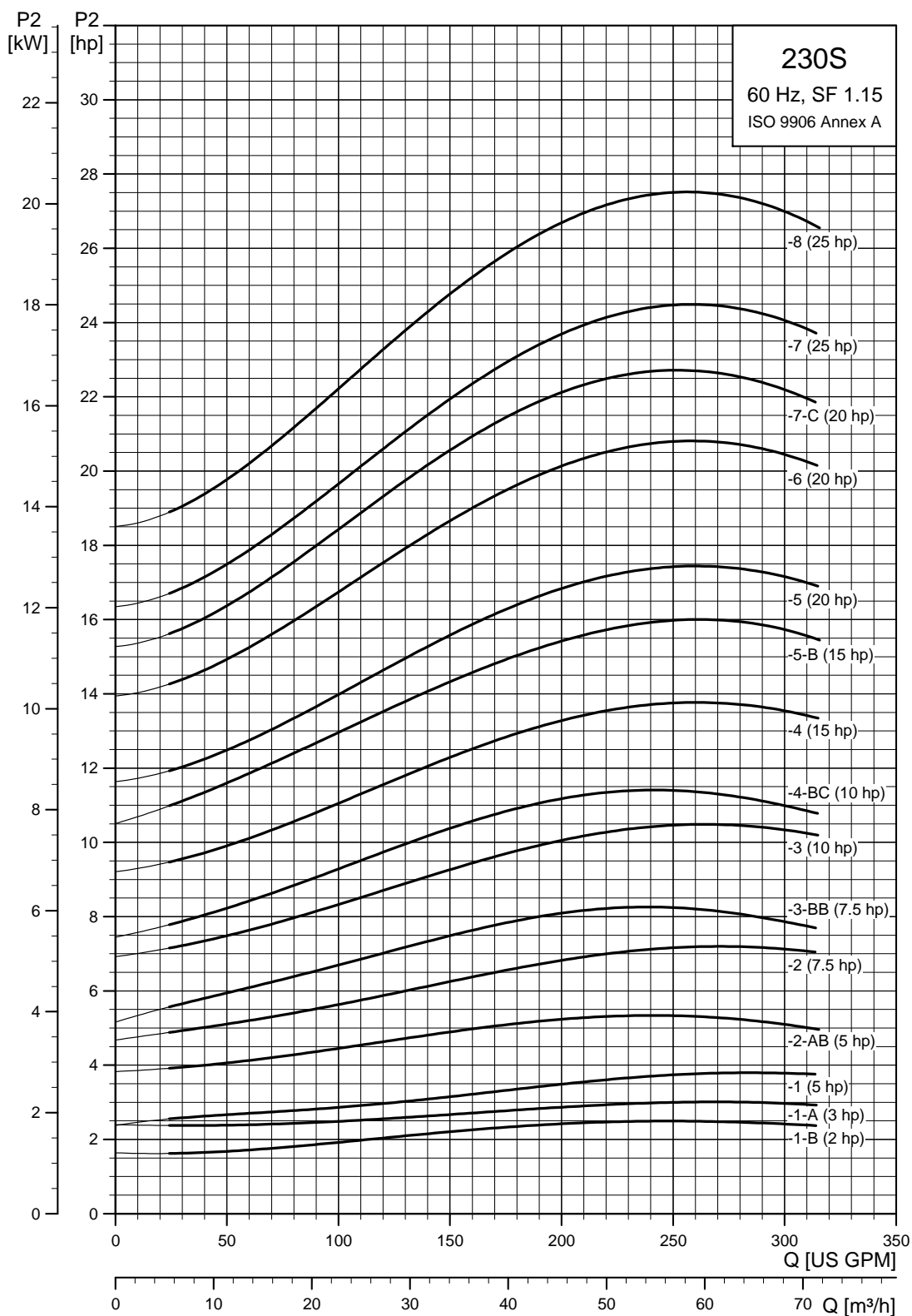

TM05 0245 1812

6" and larger wells - continued

SP 230S (230 gpm) pump power requirement (P2)

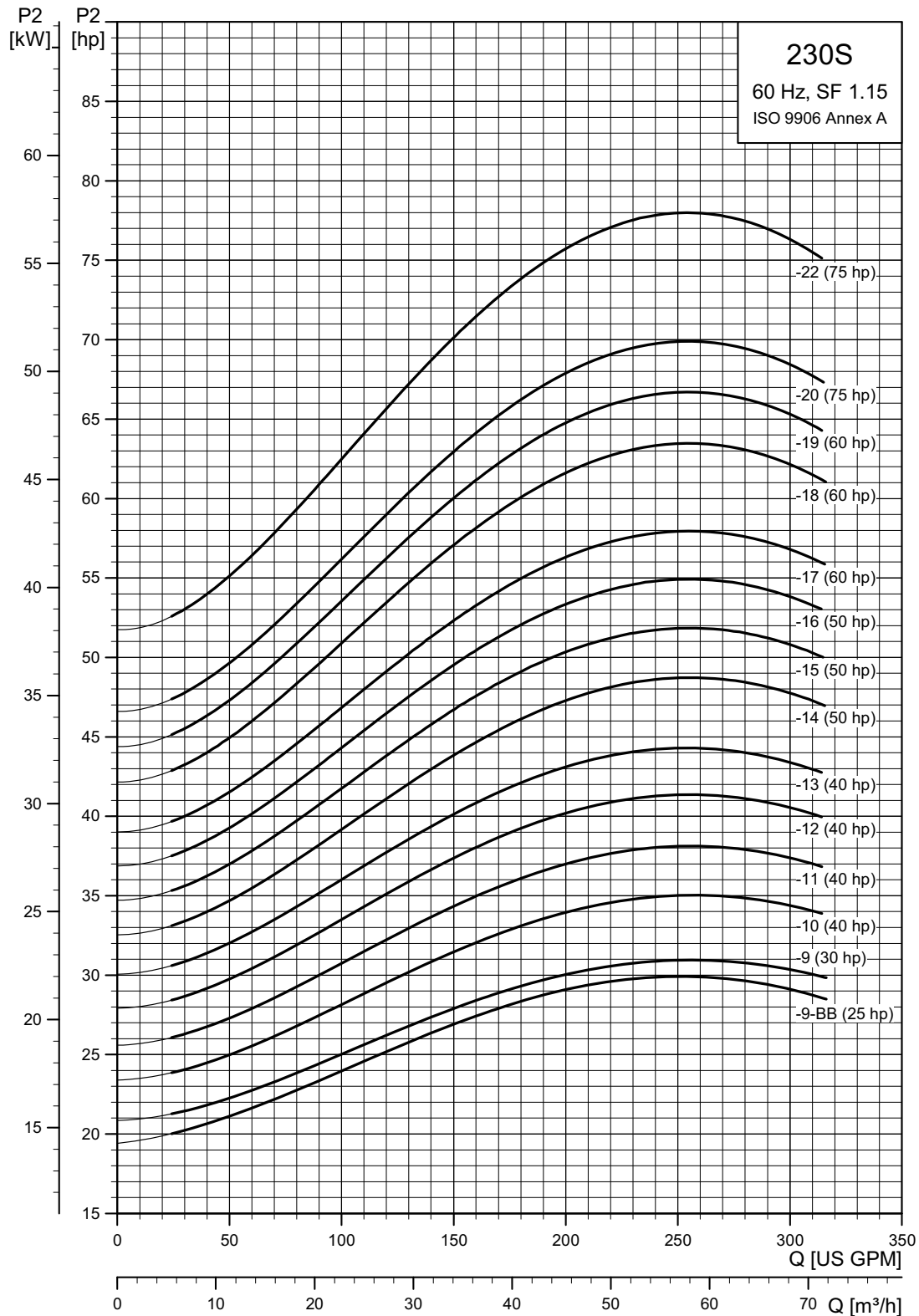

TM05 0246 5014

6" and larger wells - continued

SP 230S (230 gpm) / 4, 6 inch motor

Pump model	Nom. head [ft]	Ph	Volts [V]	Motor [Hp]	Dimensions					Net weight (complete) [lb]	
					A [in. (mm)]	B [in. (mm)]	C [in. (mm)]	D [in. (mm)]	E [in. (mm)]		
230S - Motor dia. 4 inch, 3 wire motor, 60 Hz, rated flow 230 gpm (3" NPT)											
230S20-1B	24	1	230	2	●	34.45 (875)	19.57 (497)	14.89 (378)	3.75 (95)	5.75 (146)	49.5
		3	230	2	●	30.12 (765)	15.24 (387)	14.89 (378)	3.75 (95)	5.75 (146)	49.5
		3	460	2	■	30.12 (765)	15.24 (387)	14.89 (378)	3.75 (95)	5.75 (146)	49.5
230S30-1A	30	1	230	3	●	37.60 (955)	22.72 (577)	14.89 (378)	3.75 (95)	5.75 (146)	49.5
		3	230	3	●	32.84 (834)	17.96 (456)	14.89 (378)	3.75 (95)	5.75 (146)	49.5
		3	460	3	●	32.84 (834)	17.96 (456)	14.89 (378)	3.75 (95)	5.75 (146)	49.5
230S50-1	37	1	230	5	●	41.54 (1055)	26.66 (677)	14.89 (378)	3.75 (95)	5.75 (146)	49.5
		3	230	5	●	37.56 (954)	22.68 (576)	14.89 (378)	3.75 (95)	5.75 (146)	49.5
		3	460	5	●	37.56 (954)	22.68 (576)	14.89 (378)	3.75 (95)	5.75 (146)	49.5
230S50-2AB	56	1	230	5	●	45.99 (1168)	26.66 (677)	19.34 (491)	3.75 (95)	5.75 (146)	49.5
		3	230	5	●	42.01 (1067)	22.68 (576)	19.34 (491)	3.75 (95)	5.75 (146)	79.2
		3	460	5	●	42.01 (1067)	22.68 (576)	19.34 (491)	3.75 (95)	5.75 (146)	79.2
230S75-2	80	3	230	7.5	●	45.95 (1167)	26.62 (676)	19.34 (491)	3.75 (95)	5.75 (146)	79.2
		3	460	7.5	●	45.95 (1167)	26.62 (676)	19.34 (491)	3.75 (95)	5.75 (146)	79.2
		3	230	7.5	●	50.40 (1280)	26.62 (676)	23.78 (604)	3.75 (95)	5.75 (146)	126.0
230S75-3BB	90	3	460	7.5	●	50.40 (1280)	26.62 (676)	23.78 (604)	3.75 (95)	5.75 (146)	126.0
		3	460	7.5	●	50.40 (1280)	26.62 (676)	23.78 (604)	3.75 (95)	5.75 (146)	126.0
230S100-3	123	3	460	10	●	54.34 (1380)	30.56 (776)	23.78 (604)	3.75 (95)	5.75 (146)	126.0
230S100-4BC	131	3	460	10	●	58.78 (1493)	30.56 (776)	28.23 (717)	3.75 (95)	5.75 (146)	144.9
230S - Motor dia. 6 inch, 60 Hz, rated flow 230 gpm (3" NPT)											
230S75-2	80	3	230	7.5	▲	43.47 (1104)	23.51 (597)	19.97 (507)	5.52 (140)	5.79 (147)	111.6
		3	460	7.5	▲	43.47 (1104)	23.51 (597)	19.97 (507)	5.52 (140)	5.79 (147)	111.6
230S75-3BB	90	3	230	7.5	▲	47.92 (1217)	23.51 (597)	24.41 (620)	5.52 (140)	5.79 (147)	131.4
		3	460	7.5	▲	47.92 (1217)	23.51 (597)	24.41 (620)	5.52 (140)	5.79 (147)	131.4
230S100-3	123	3	230	10	▲	49.10 (1247)	24.69 (627)	24.41 (620)	5.52 (140)	5.79 (147)	126.0
		3	460	10	▲	49.10 (1247)	24.69 (627)	24.41 (620)	5.52 (140)	5.79 (147)	126.0
230S100-4BC	131	3	230	10	▲	53.55 (1360)	24.69 (627)	28.86 (733)	5.52 (140)	5.79 (147)	144.9
		3	460	10	▲	53.55 (1360)	24.69 (627)	28.86 (733)	5.52 (140)	5.79 (147)	144.9
230S150-4	166	3	230	15	▲	55.91 (1420)	27.05 (687)	28.86 (733)	5.52 (140)	5.79 (147)	144.9
		3	460	15	▲	55.91 (1420)	27.05 (687)	28.86 (733)	5.52 (140)	5.79 (147)	144.9
230S150-5B	195	3	230	15	▲	60.36 (1533)	27.05 (687)	33.31 (846)	5.52 (140)	5.79 (147)	161.1
		3	460	15	▲	60.36 (1533)	27.05 (687)	33.31 (846)	5.52 (140)	5.79 (147)	161.1
230S200-5	208	3	230	20	▲	62.92 (1598)	29.61 (752)	33.31 (846)	5.52 (140)	5.79 (147)	161.1
		3	460	20	▲	62.92 (1598)	29.61 (752)	33.31 (846)	5.52 (140)	5.79 (147)	161.1
230S200-6	251	3	230	20	▲	67.37 (1711)	29.61 (752)	37.76 (959)	5.52 (140)	5.79 (147)	167.4
		3	460	20	▲	67.37 (1711)	29.61 (752)	37.76 (959)	5.52 (140)	5.79 (147)	167.4
230S200-7C	276	3	230	20	▲	71.82 (1824)	29.61 (752)	42.21 (1072)	5.52 (140)	5.79 (147)	181.8
		3	460	20	▲	71.82 (1824)	29.61 (752)	42.21 (1072)	5.52 (140)	5.79 (147)	181.8

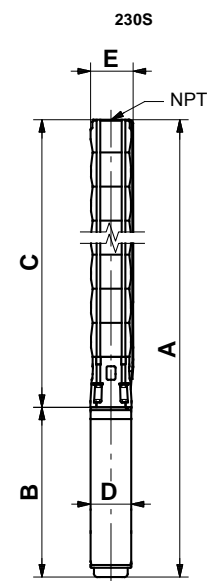

TMO0 0961 1196

E = Maximum diameter of pump including cable guard and motor.

Notes:

Control box is required for 3-wire, single-phase applications. Data does not include control box. Performance conforms to ISO 9906: 1999 (E) Annex A. Minimum submergence is 2 feet.

- MS 402 motor.
- MS 4000 motor.
- ▲ MS 6000C motor.

6" and larger wells - continued

SP 230S (230 gpm) / 6, 8 inch motor

Pump model	Nom. head [ft]	Ph	Volts [V]	Motor [Hp]	Dimensions					Net weight (complete) [lb]	
					A [in. (mm)]	B [in. (mm)]	C [in. (mm)]	D [in. (mm)]	E [in. (mm)]		
230S - Motor dia. 6 inch, 60 Hz, rated flow 230 gpm (3" NPT)											
230S250-7	294	3	230	25	▲	73.98 (1879)	31.78 (807)	42.21 (1072)	5.52 (140)	5.79 (147)	149.9
		3	460	25	▲	73.98 (1879)	31.78 (807)	42.21 (1072)	5.52 (140)	5.79 (147)	181.8
230S250-8B	329	3	230	25	▲	78.43 (1992)	31.78 (807)	46.66 (1185)	5.52 (140)	5.79 (147)	188.1
		3	460	25	▲	78.43 (1992)	31.78 (807)	46.66 (1185)	5.52 (140)	5.79 (147)	188.1
230S250-8	336	3	230	25	▲	78.43 (1992)	31.78 (807)	46.66 (1185)	5.52 (140)	5.79 (147)	188.1
		3	460	25	▲	78.43 (1992)	31.78 (807)	46.66 (1185)	5.52 (140)	5.79 (147)	188.1
230S250-9BB	352	3	230	25	▲	82.88 (2105)	31.78 (807)	51.11 (1298)	5.52 (140)	5.79 (147)	205.2
		3	460	25	▲	82.88 (2105)	31.78 (807)	51.11 (1298)	5.52 (140)	5.79 (147)	205.2
230S300-9	379	3	230	30	▲	85.24 (2165)	34.14 (867)	51.11 (1298)	5.52 (140)	5.79 (147)	205.2
		3	460	30	▲	85.24 (2165)	34.14 (867)	51.11 (1298)	5.52 (140)	5.79 (147)	205.2
230S400-10	422	3	460	40	▲	94.81 (2408)	39.26 (997)	55.56 (1411)	5.52 (140)	5.79 (147)	241.2
230S400-11	465	3	460	40	▲	99.26 (2521)	39.26 (997)	60.00 (1524)	5.52 (140)	5.79 (147)	245.7
230S400-12	507	3	460	40	▲	103.71 (2634)	39.26 (997)	64.45 (1637)	5.52 (140)	5.79 (147)	251.1
230S400-13	550	3	460	40	▲	108.15 (2747)	39.26 (997)	68.90 (1750)	5.52 (140)	5.79 (147)	255.6
230S500-14	593	3	460	50	▲	129.45 (3288)	56.11 (1425)	73.35 (1863)	5.67 (144)	5.79 (147)	356.0
230S500-15	635	3	460	50	▲	133.90 (3401)	56.11 (1425)	77.80 (1976)	5.67 (144)	5.79 (147)	360.5
230S500-16	678	3	460	50	▲	138.35 (3514)	56.11 (1425)	82.25 (2089)	5.67 (144)	5.79 (147)	365.0
230S600-17	721	3	460	60	☼	-	-	86.70 (2202)	-	5.79 (147)	-
230S600-18	763	3	460	60	☼	-	-	91.15 (2315)	-	5.79 (147)	-
230S600-19	806	3	460	60	☼	-	-	95.60 (2428)	-	5.79 (147)	-
230S - Motor dia. 8 inch, 60 Hz, rated flow 230 gpm (3" NPT)											
230S600-17	721	3	460	60	★	138.47 (3517)	50.00 (1270)	88.47 (2247)	7.56 (192)	7.56 (192)	546.0
230S600-18	763	3	460	60	★	142.92 (3630)	50.00 (1270)	92.92 (2360)	7.56 (192)	7.56 (192)	568.5
230S600-19	806	3	460	60	★	147.37 (3743)	50.00 (1270)	97.37 (2473)	7.56 (192)	7.56 (192)	591.0
230S750-20DS	849	3	460	75	★	164.69 (4183)	53.15 (1350)	111.54 (2833)	7.56 (192)	7.56 (192)	549.9
230S750-22DS	934	3	460	75	★	173.59 (4409)	53.15 (1350)	120.44 (3059)	7.56 (192)	7.56 (192)	620.4

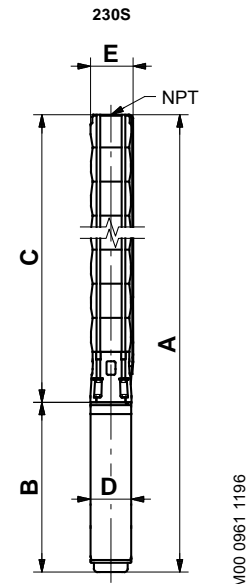

E = Maximum diameter of pump including cable guard and motor.

TM00 0961 1196

Notes:

Control box is required for 3-wire, single-phase applications. Data does not include control box.

DS designation = Built into sleeve, 1 - 1/2" NPT, 6" minimum well diameter.

Performance conforms to ISO 9906: 1999 (E) Annex A. Minimum submergence is 2 feet.

- ▲ MS 6000C motor.
- ▲ MMS 6 motor.
- ★ MMS 8000 motor.
- ☼ Takes MMS 6 motor; not available as complete.

6" and larger wells - continued

SP 300S (300 gpm)

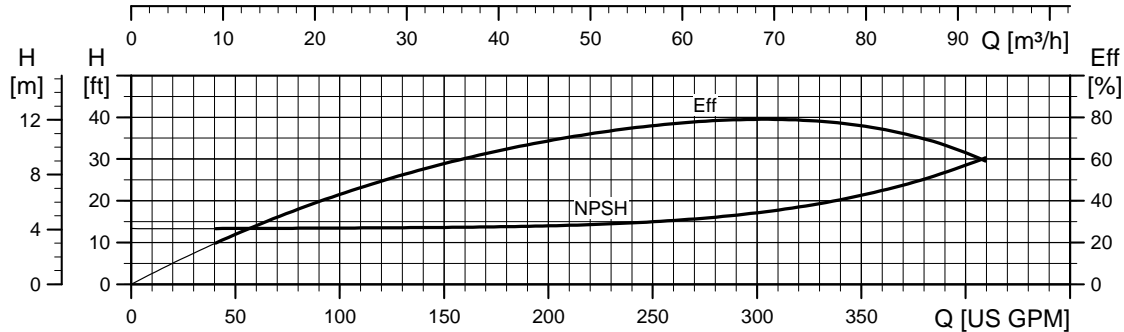
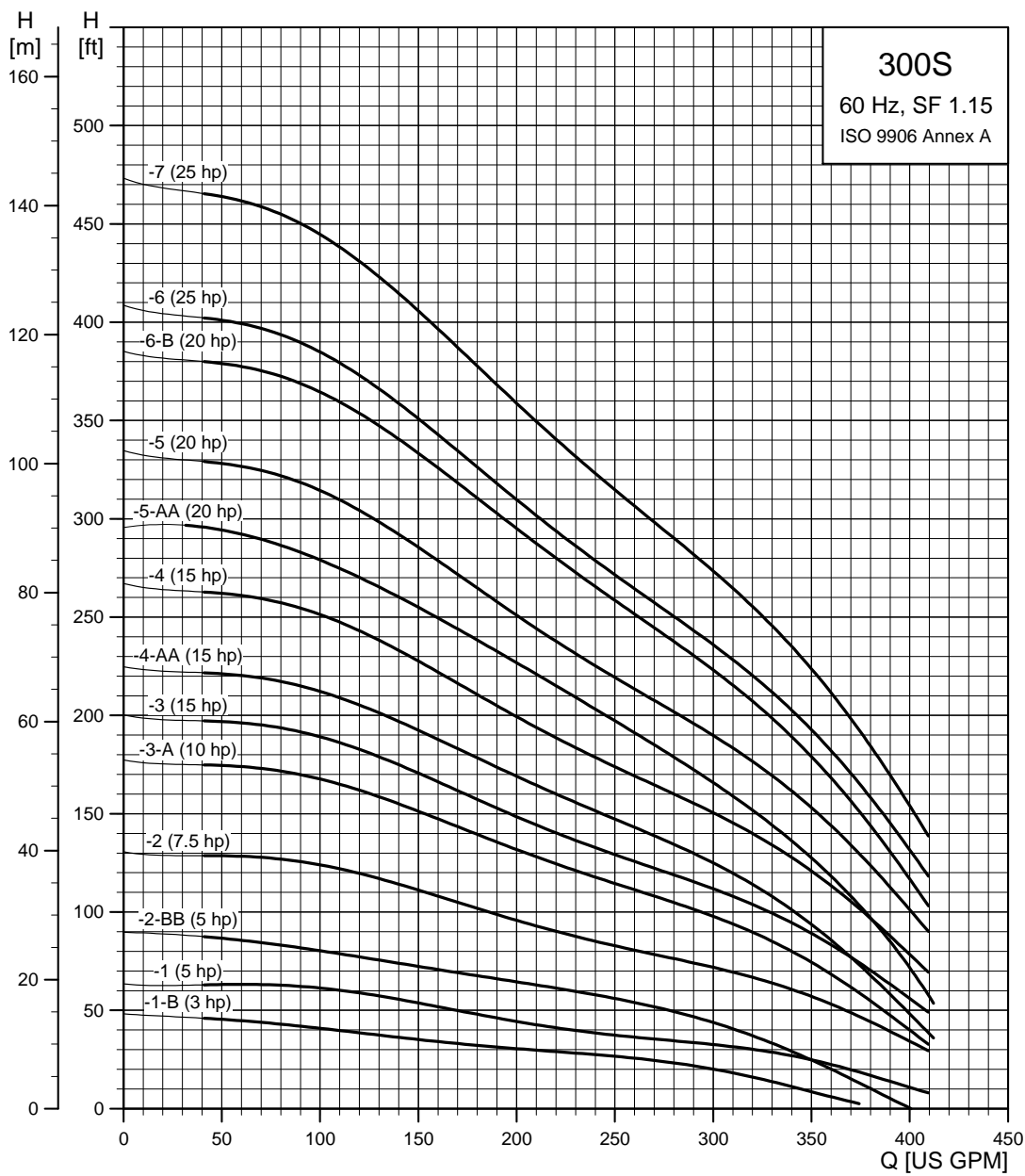

TM05 0247 1812

6" and larger wells - continued SP 300S (300 gpm)

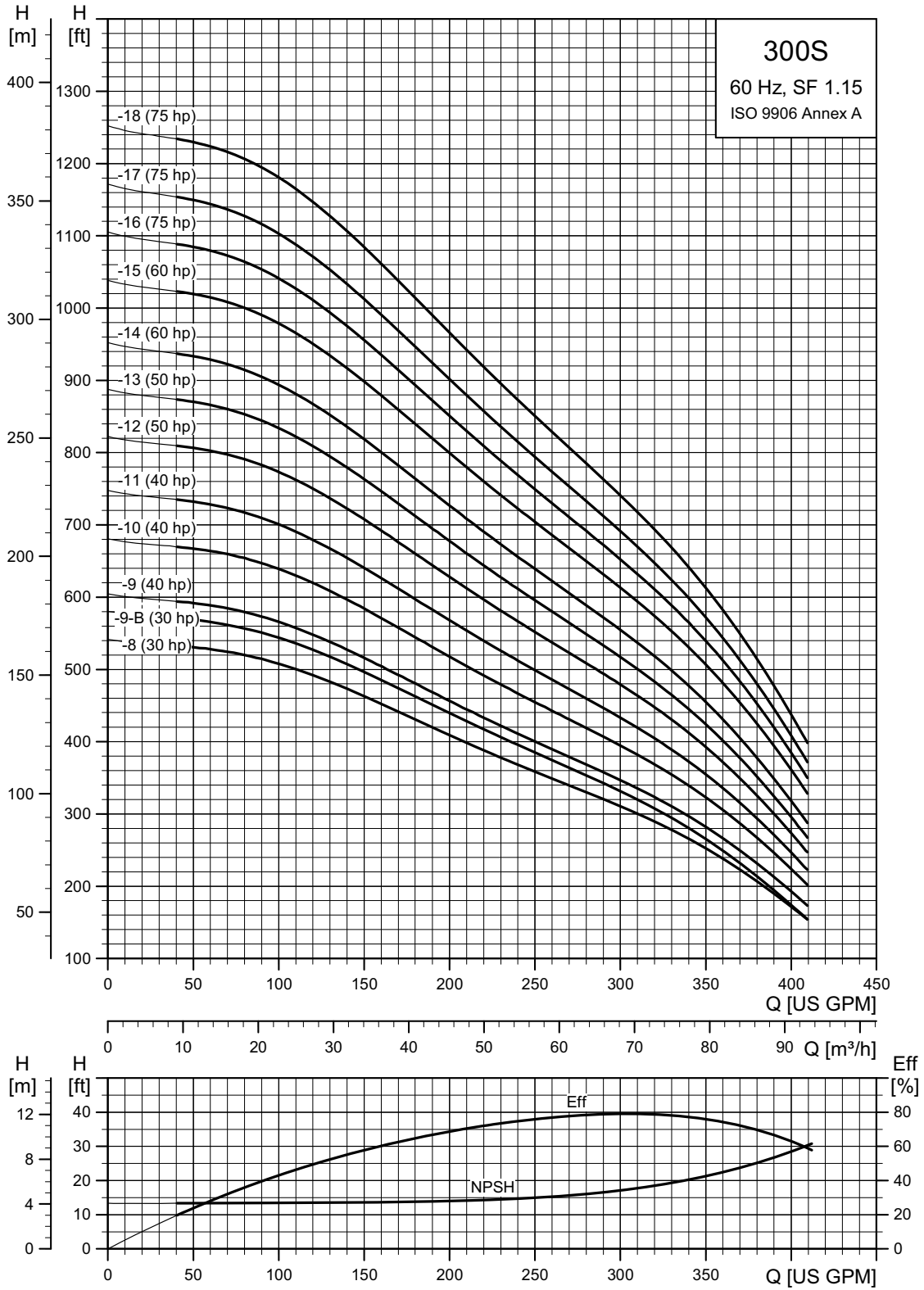

TM05 0248 5014

6" and larger wells - continued

SP 300S (300 gpm) pump power requirement (P2)

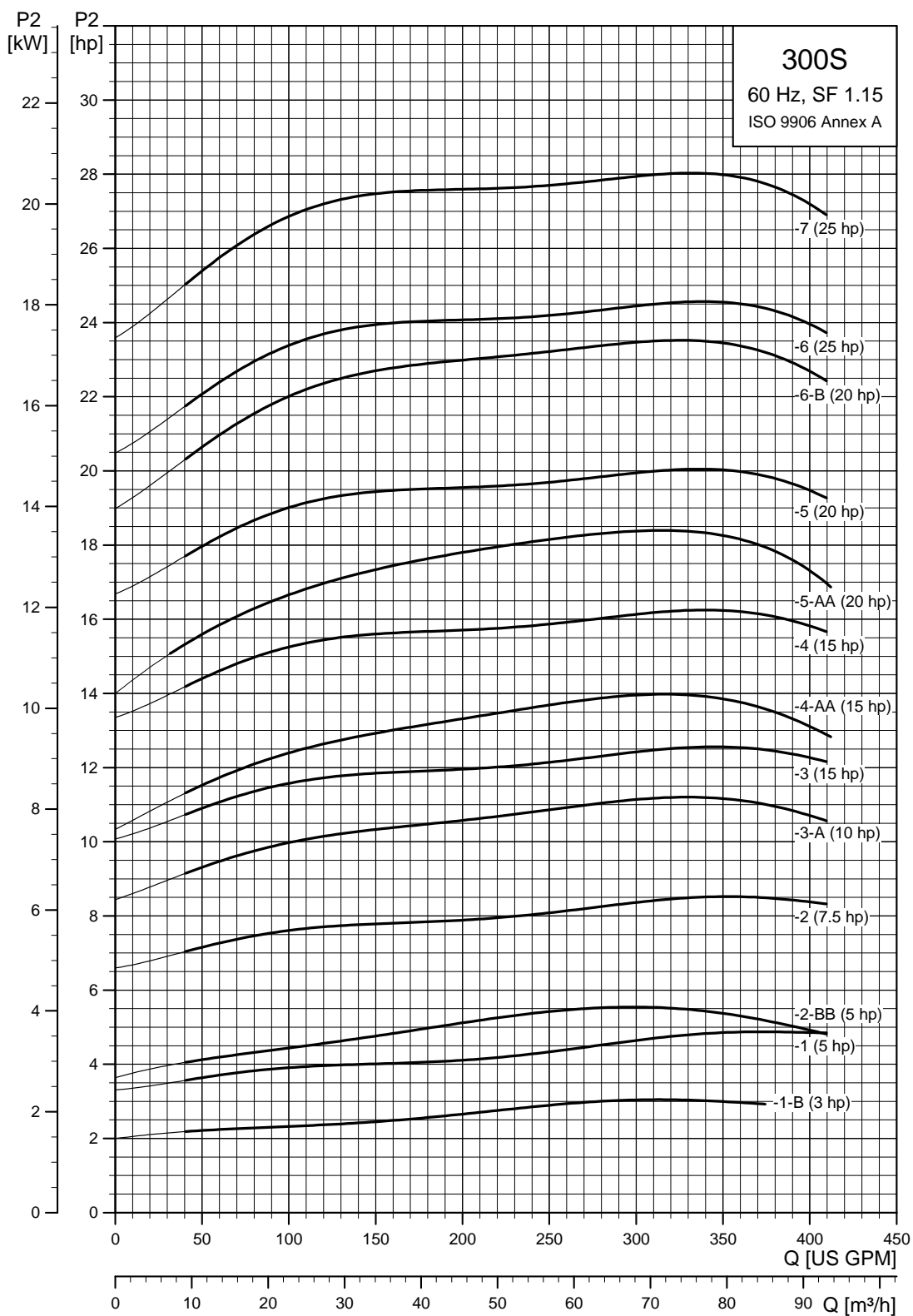

TM05 0249 1812

6" and larger wells - continued

SP 300S (300 gpm) pump power requirement (P2)

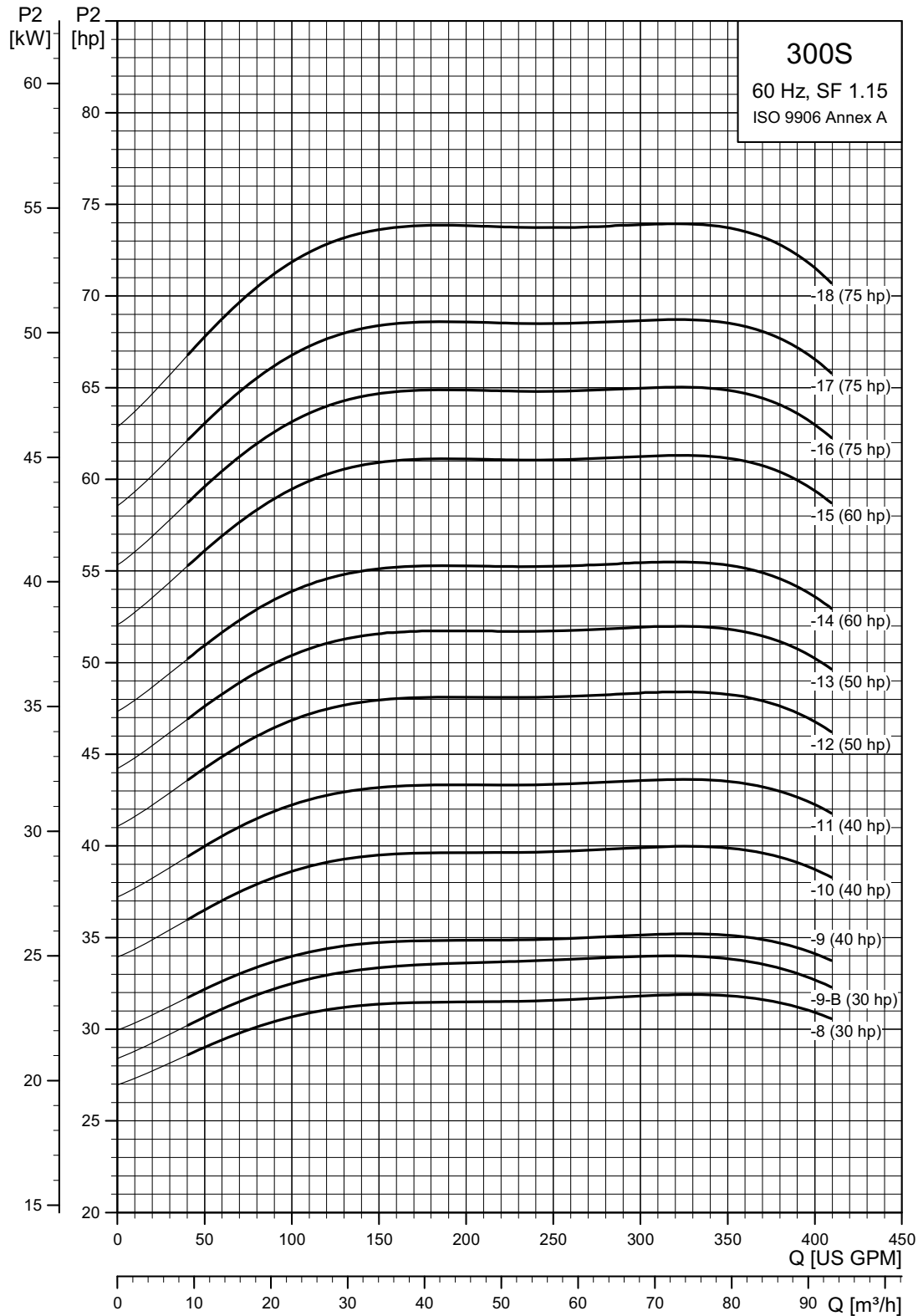

TM05 0250 5014

6" and larger wells - continued

SP 300S (300 gpm) / 4, 6 inch motor

Pump model	Nom. head [ft]	Ph	Volts [V]	Motor [Hp]	Dimensions					Net weight (complete) [lb]	
					A [in. (mm)]	B [in. (mm)]	C [in. (mm)]	D [in. (mm)]	E [in. (mm)]		
300S - Motor dia. 4 inch, 3 wire motor, 60 Hz, rated flow 300 gpm (3" NPT)											
300S30-1B	19	1	230	3	●	37.60 (955)	22.72 (577)	14.89 (378)	3.75 (95)	5.75 (146)	72.0
		3	230	3	●	32.84 (834)	17.96 (456)	14.89 (378)	3.75 (95)	5.75 (146)	72.0
		3	460	3	●	32.84 (834)	17.96 (456)	14.89 (378)	3.75 (95)	5.75 (146)	72.0
300S50-1	31	1	230	5	●	41.54 (1055)	26.66 (677)	14.89 (378)	3.75 (95)	5.75 (146)	74.7
		3	230	5	●	37.56 (954)	22.68 (576)	14.89 (378)	3.75 (95)	5.75 (146)	74.7
		3	460	5	●	37.56 (954)	22.68 (576)	14.89 (378)	3.75 (95)	5.75 (146)	74.7
300S50-2BB	42	1	230	5	●	45.99 (1168)	26.66 (677)	19.34 (491)	3.75 (95)	5.75 (146)	135.0
		3	230	5	●	42.01 (1067)	22.68 (576)	19.34 (491)	3.75 (95)	5.75 (146)	135.0
		3	460	5	●	42.01 (1067)	22.68 (576)	19.34 (491)	3.75 (95)	5.75 (146)	135.0
300S75-2	70	3	230	7.5	●	45.95 (1167)	26.62 (676)	19.34 (491)	3.75 (95)	5.75 (146)	101.7
		3	460	7.5	●	45.95 (1167)	26.62 (676)	19.34 (491)	3.75 (95)	5.75 (146)	101.7
300S100-3A	97	3	460	10	●	54.34 (1380)	30.56 (776)	23.78 (604)	3.75 (95)	5.75 (146)	145.8
300S - Motor dia. 6 inch, 60 Hz, rated flow 300 gpm (3" NPT)											
300S75-2	70	3	230	7.5	▲	43.47 (1104)	23.51 (597)	19.97 (507)	5.52 (140)	5.79 (147)	167.4
		3	460	7.5	▲	43.47 (1104)	23.51 (597)	19.97 (507)	5.52 (140)	5.79 (147)	167.4
300S100-3A	97	3	230	10	▲	49.10 (1247)	24.69 (627)	24.41 (620)	5.52 (140)	5.79 (147)	216.0
		3	460	10	▲	49.10 (1247)	24.69 (627)	24.41 (620)	5.52 (140)	5.79 (147)	216.0
300S150-3	110	3	230	15	▲	51.46 (1307)	27.05 (687)	24.41 (620)	5.52 (140)	5.79 (147)	216.0
		3	460	15	▲	51.46 (1307)	27.05 (687)	24.41 (620)	5.52 (140)	5.79 (147)	216.0
300S150-4AA	123	3	230	15	▲	55.91 (1420)	27.05 (687)	28.86 (733)	5.52 (140)	5.79 (147)	222.3
		3	460	15	▲	55.91 (1420)	27.05 (687)	28.86 (733)	5.52 (140)	5.79 (147)	222.3
300S150-4	149	3	230	15	▲	55.91 (1420)	27.05 (687)	28.86 (733)	5.52 (140)	5.79 (147)	222.3
		3	460	15	▲	55.91 (1420)	27.05 (687)	28.86 (733)	5.52 (140)	5.79 (147)	222.3
300S200-5AA	170	3	230	20	▲	62.92 (1598)	29.61 (752)	33.31 (846)	5.52 (140)	5.79 (147)	194.4
		3	460	20	▲	62.92 (1598)	29.61 (752)	33.31 (846)	5.52 (140)	5.79 (147)	194.4
300S200-5	188	3	230	20	▲	62.92 (1598)	29.61 (752)	33.31 (846)	5.52 (140)	5.79 (147)	194.4
		3	460	20	▲	62.92 (1598)	29.61 (752)	33.31 (846)	5.52 (140)	5.79 (147)	194.4
300S200-6B	211	3	230	20	▲	67.37 (1711)	29.61 (752)	37.76 (959)	5.52 (140)	5.79 (147)	198.0
		3	460	20	▲	67.37 (1711)	29.61 (752)	37.76 (959)	5.52 (140)	5.79 (147)	198.0
300S250-6	228	3	230	25	▲	69.53 (1766)	31.78 (807)	37.76 (959)	5.52 (140)	5.79 (147)	198.0
		3	460	25	▲	69.53 (1766)	31.78 (807)	37.76 (959)	5.52 (140)	5.79 (147)	198.0

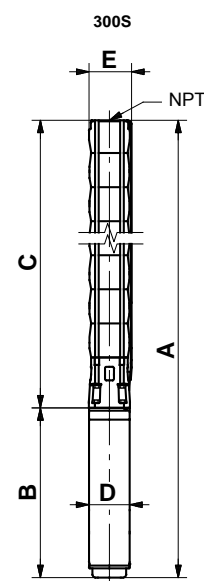

E = Maximum diameter of pump including cable guard and motor.

TM00 0961 1196

Notes:

Control box is required for 3-wire, single-phase applications. Data does not include control box. Performance conforms to ISO 9906. 1999 (E) Annex A. Minimum submergence is 2 feet.

- MS 4000 motor.
- ▲ MS 6000C motor.

6" and larger wells - continued

SP 300S (300 gpm) / 6, 8 inch motor

Pump model	Nom. head [ft]	Ph	Volts [V]	Motor [Hp]	Dimensions					Net weight (complete) [lb]	
					A [in. (mm)]	B [in. (mm)]	C [in. (mm)]	D [in. (mm)]	E [in. (mm)]		
300S - Motor dia. 6 inch, 60 Hz, rated flow 300 gpm (4" NPT)											
300S250-7AA	249	3	230	25	▲	73.98 (1879)	31.78 (807)	42.21 (1072)	5.52 (140)	5.79 (147)	217.8
					▲	73.98 (1879)	31.78 (807)	42.21 (1072)	5.52 (140)	5.79 (147)	217.8
300S300-7	267	3	230	30	▲	76.34 (1939)	34.14 (867)	42.21 (1072)	5.52 (140)	5.79 (147)	217.8
					▲	76.34 (1939)	34.14 (867)	42.21 (1072)	5.52 (140)	5.79 (147)	217.8
300S300-8	307	3	230	30	▲	80.79 (2052)	34.14 (867)	46.66 (1185)	5.52 (140)	5.79 (147)	224.1
					▲	80.79 (2052)	34.14 (867)	46.66 (1185)	5.52 (140)	5.79 (147)	224.1
300S300-9B	329	3	230	30	▲	85.24 (2165)	34.14 (867)	51.11 (1298)	5.52 (140)	5.79 (147)	261.0
					▲	85.24 (2165)	34.14 (867)	51.11 (1298)	5.52 (140)	5.79 (147)	261.0
300S400-9	346	3	460	40	▲	90.36 (2295)	39.26 (997)	51.11 (1298)	5.52 (140)	5.79 (147)	296.0
300S400-10	385	3	460	40	▲	94.81 (2408)	39.26 (997)	55.56 (1411)	5.52 (140)	5.79 (147)	300.5
300S400-11	425	3	460	40	☼	99.26 (2521)	39.26 (997)	60.00 (1524)	5.52 (140)	5.79 (147)	352.0
300S500-12	464	3	460	50	☼	120.56 (3062)	56.11 (1425)	64.45 (1637)	5.67 (144)	5.79 (147)	348.8
300S500-13	504	3	460	50	☼	125.00 (3175)	56.11 (1425)	68.90 (1750)	5.67 (144)	5.79 (147)	355.1
300S600-14	543	3	460	60	*	-	-	73.35 (1863)	-	5.79 (147)	-
300S600-15	582	3	460	60	*	-	-	77.80 (1976)	-	5.79 (147)	-
SP 300S - Motor dia. 8 inch, 60 Hz, rated flow 230 gpm (4" NPT)											
300S600-14	543	3	460	60	*	125.12 (3178)	50.00 (1270)	75.12 (1908)	7.56 (192)	7.56 (192)	479.4
300S600-15	582	3	460	60	*	129.57 (3291)	50.00 (1270)	79.57 (2021)	7.56 (192)	7.56 (192)	519.4
300S750-16	622	3	460	75	*	137.17 (3484)	53.15 (1350)	84.02 (2134)	7.56 (192)	7.56 (192)	569.1
300S750-17	661	3	460	75	*	141.62 (3597)	53.15 (1350)	88.47 (2247)	7.56 (192)	7.56 (192)	575.4
300S750-18	701	3	460	75	*	146.07 (3710)	53.15 (1350)	92.92 (2360)	7.56 (192)	7.56 (192)	581.7

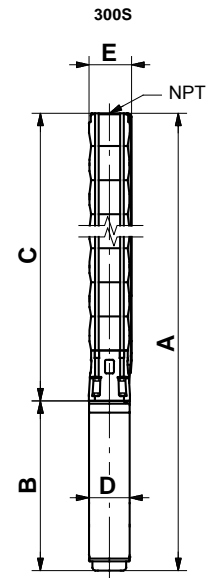

TM00 0961 1196

E = Maximum diameter of pump including cable guard and motor.

Notes:

Control box is required for 3-wire, single-phase applications. Data does not include control box. Performance conforms to ISO 9906 Annex A @ 8 ft. minimum submergence.

- ▲ MS 6000C motor.
- ☼ Takes MMS 6 motor; not available as complete.
- * Takes MMS 8000 motor; not available as complete.

8" and larger wells SP 385S (385 gpm)

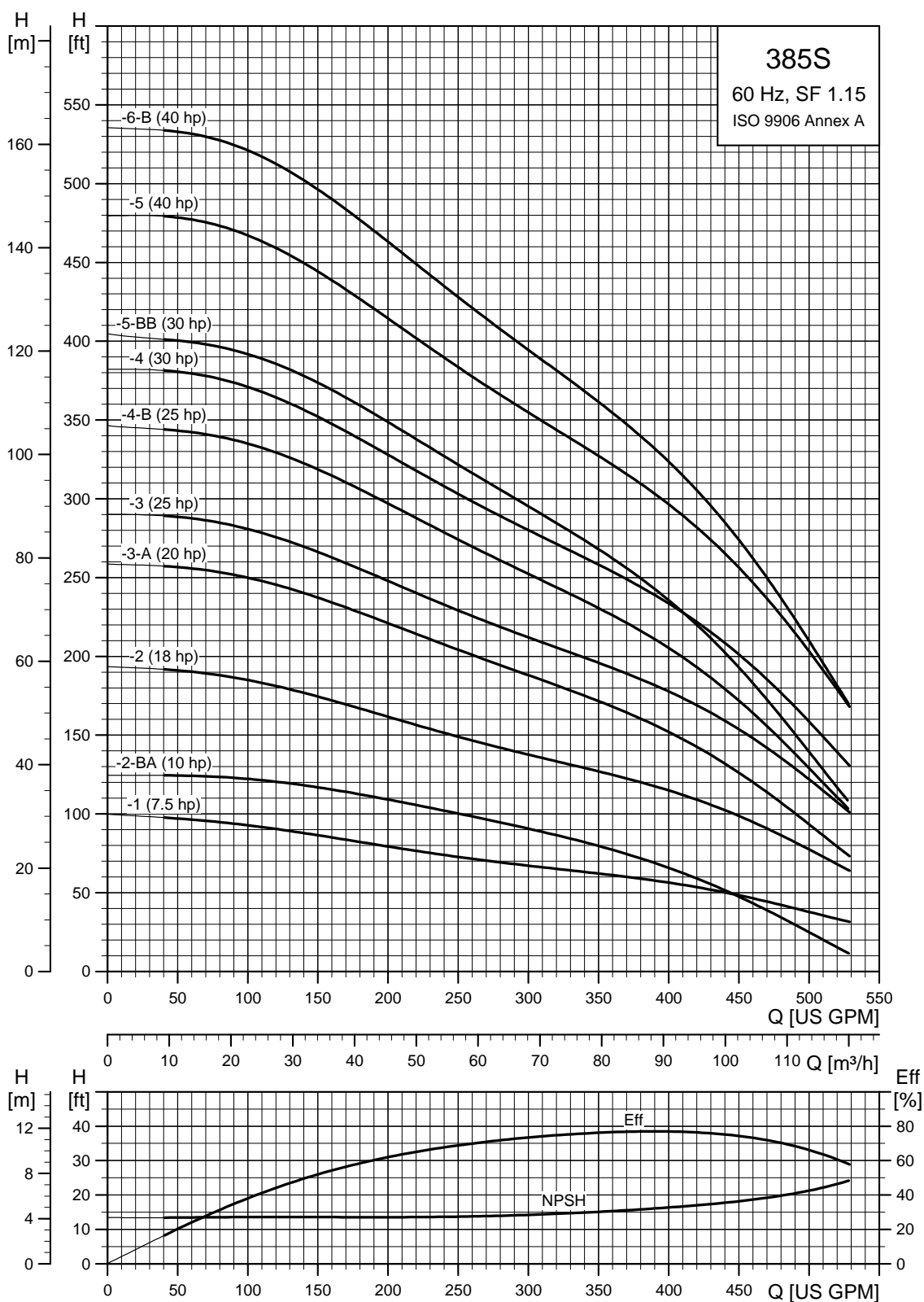

TM05 0251 1812

8" and larger wells - continued

SP 385S (385 gpm)

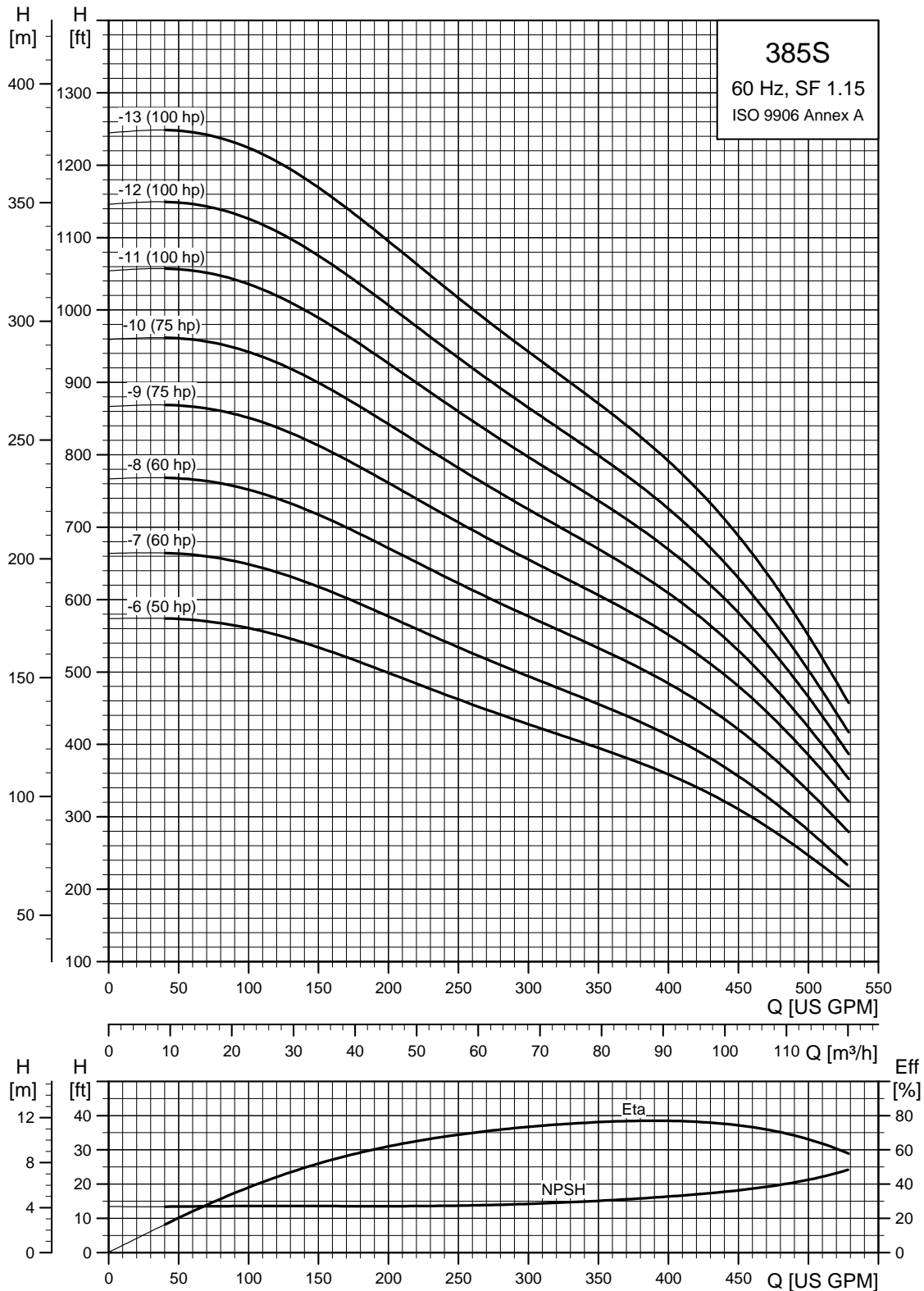

TM05 0252 1812

8" and larger wells - continued

SP 385S (385 gpm) pump power requirement (P2)

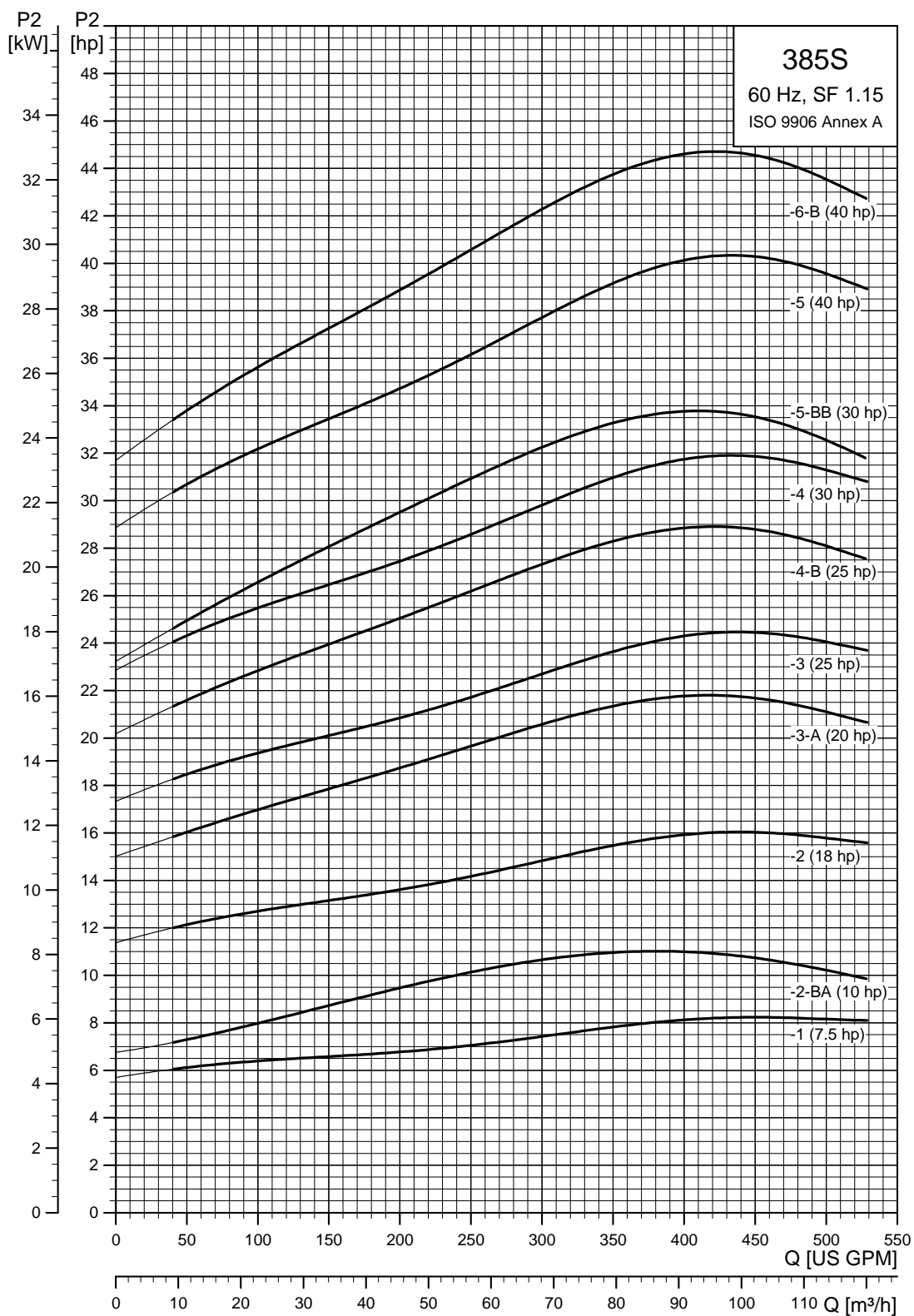

TM05 0253 1812

8" and larger wells - continued

SP 385S (385 gpm) pump power requirement (P2)

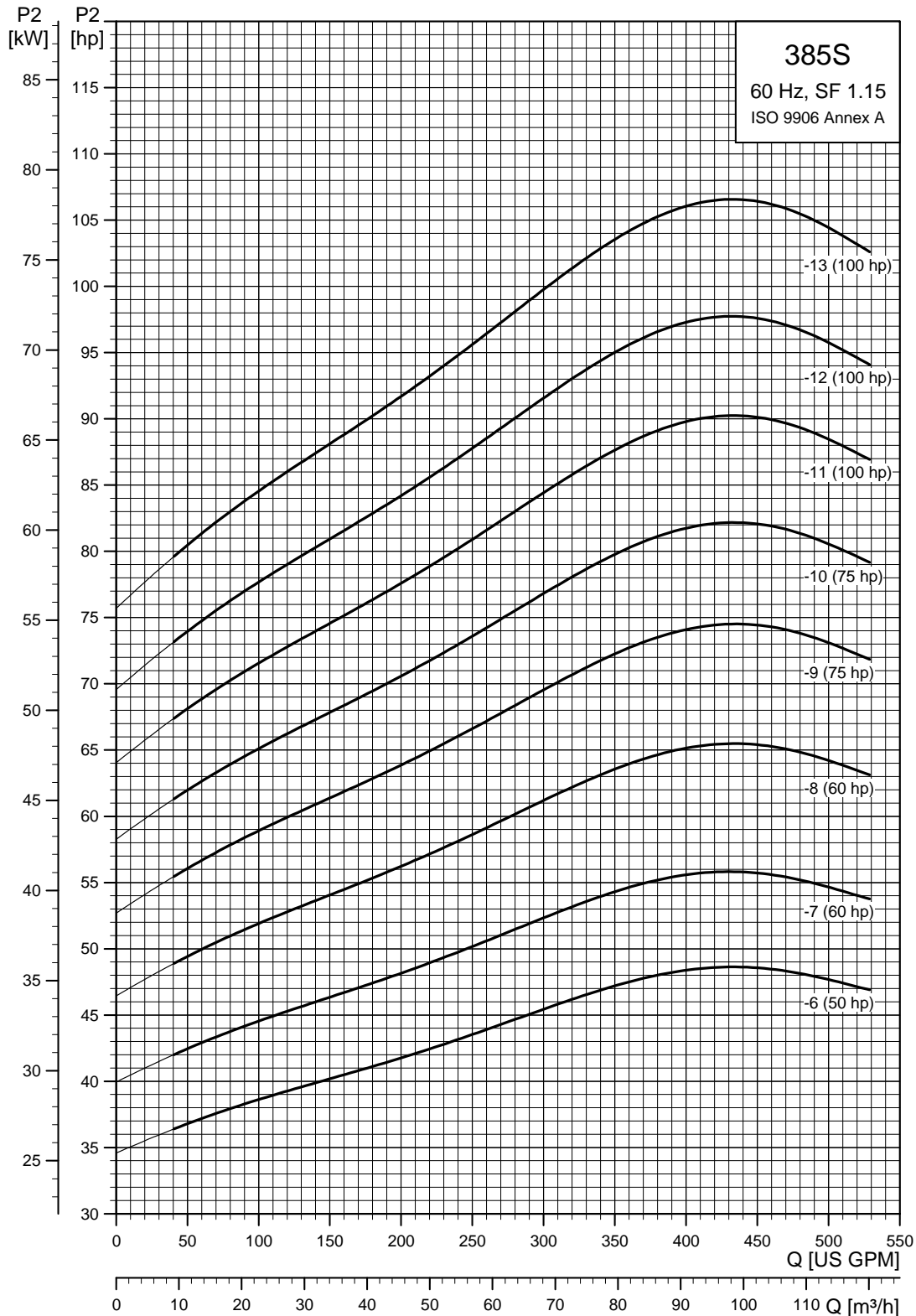

TM05 0254 1812

8" and larger wells - continued

SP 385S (385 gpm) / 6, 8, 10 inch motor

Pump model	Nom. head [ft]	Ph	Volts [V]	Motor [Hp]	Dimensions					Net weight (complete) [lb]
					A [in. (mm)]	B [in. (mm)]	C [in. (mm)]	D [in. (mm)]	E [in. (mm)]	
385S - Motor dia. 6 inch, 60 Hz, rated flow 385 gpm (4" NPT)										
385S75-1	57	3	230	7.5 ▲	46.58 (1183)	22.25 (565)	24.34 (618)	5.63 (143)	7.01 (178)	135.9
		3	460	7.5 ▲	46.58 (1183)	22.25 (565)	24.34 (618)	5.63 (143)	7.01 (178)	135.9
385S100-2BA	69	3	230	10 ▲	52.6 (1336)	23.23 (590)	29.38 (746)	5.63 (143)	7.01 (178)	169.2
		3	460	10 ▲	52.6 (1336)	23.23 (590)	29.38 (746)	5.63 (143)	7.01 (178)	169.2
385S150-2	117	3	230	15 ▲	57.25 (1454)	27.88 (708)	29.38 (746)	5.63 (143)	7.01 (178)	169.2
		3	460	15 ▲	57.25 (1454)	27.88 (708)	29.38 (746)	5.63 (143)	7.01 (178)	169.2
385S200-3A	155	3	230	20 ▲	65.24 (1657)	30.83 (783)	34.41 (874)	5.63 (143)	7.01 (178)	188.1
		3	460	20 ▲	65.24 (1657)	30.83 (783)	34.41 (874)	5.63 (143)	7.01 (178)	188.1
385S250-3	177	3	230	25 ▲	67.41 (1712)	33.00 (838)	34.41 (874)	5.63 (143)	7.01 (178)	188.1
		3	460	25 ▲	67.41 (1712)	33.00 (838)	34.41 (874)	5.63 (143)	7.01 (178)	188.1
385S250-4B	210	3	230	25 ▲	72.45 (1840)	33.00 (838)	39.45 (1002)	5.63 (143)	7.01 (178)	239.4
		3	460	25 ▲	72.45 (1840)	33.00 (838)	39.45 (1002)	5.63 (143)	7.01 (178)	239.4
385S300-4	237	3	230	30 ▲	75.00 (1905)	35.56 (903)	39.45 (1002)	5.63 (143)	7.01 (178)	239.4
		3	460	30 ▲	75.00 (1905)	35.56 (903)	39.45 (1002)	5.63 (143)	7.01 (178)	239.4
385S300-5BB	343	3	230	30 ▲	80.04 (2033)	35.56 (903)	44.49 (1130)	5.63 (143)	7.01 (178)	247.5
		3	460	30 ▲	80.04 (2033)	35.56 (903)	44.49 (1130)	5.63 (143)	7.01 (178)	247.5
385S400-5	297	3	460	40 ▲	84.77 (2153)	40.28 (1023)	44.49 (1130)	5.63 (143)	7.01 (178)	247.5
385S400-6B	330	3	460	40 ▲	89.81 (2281)	40.28 (1023)	49.53 (1258)	5.63 (143)	7.01 (178)	252.0
385S500-6	357	3	460	50 ✨	110.99 (2825)	56.11 (1425)	54.88 (1394)	5.67 (144)	7.88 (200)	-
385S500-7A	400	3	460	50 ✨	110.99 (2825)	56.11 (1425)	54.88 (1394)	5.67 (144)	7.88 (200)	-
385S600-7	416	3	460	60 †	-	-	55.12 (1400)	-	7.88 (200)	-
385S600-8	476	3	460	60 †	-	-	55.12 (1400)	-	7.88 (200)	-
385S - Motor dia. 8 inch, 60 Hz, rated flow 385 gpm (4" NPT)										
385S400-6B	330	3	460	40 *	93.78 (2382)	43.71 (1110)	50.08 (1272)	7.56 (192)	7.88 (200)	428.3
385S500-6	357	3	460	50 *	95.75 (2432)	45.67 (1160)	50.08 (1272)	7.56 (192)	7.88 (200)	451.2
385S500-7A	400	3	460	50 *	100.79 (2560)	45.67 (1160)	55.12 (1400)	7.56 (192)	7.88 (200)	461.1
385S600-7	416	3	460	60 *	105.12 (2670)	50.00 (1270)	55.12 (1400)	7.56 (192)	7.88 (200)	507.3
385S600-8	476	3	460	60 *	110.16 (2798)	50.00 (1270)	60.16 (1528)	7.56 (192)	7.88 (200)	517.2
385S750-9	536	3	460	75 *	118.35 (3006)	53.15 (1350)	65.2 (1656)	7.56 (192)	7.88 (200)	558.7
385S750-10	596	3	460	75 *	123.39 (3134)	53.15 (1350)	70.24 (1784)	7.56 (192)	7.88 (200)	568.6
385S1000-11	656	3	460	100 *	137.88 (3502)	62.60 (1590)	75.28 (1912)	7.56 (192)	7.88 (200)	677.5
385S1000-12	716	3	460	100 *	142.92 (3630)	62.60 (1590)	80.32 (2040)	7.56 (192)	7.88 (200)	687.4
385S1000-13	776	3	460	100 *	147.96 (3758)	62.60 (1590)	85.36 (2168)	7.56 (192)	7.88 (200)	697.3

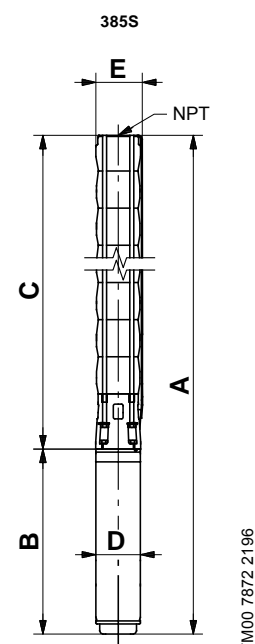

TM00 7872 2196

E = Maximum diameter of pump including cable guard and motor.

Notes:

Control box is required for 3-wire, single-phase applications. Data does not include control box. Performance conforms to ISO 9906 Annex A @ 8 ft. minimum submergence.

- ▲ MS 6000C motor.
- ✨ Takes MMS 6 motor; not available as complete.
- * Takes MMS 8000 motor; not available as complete.
- † Takes MMS 10000 motor; not available as complete.

8" and larger wells - continued SP 475S (475 gpm)

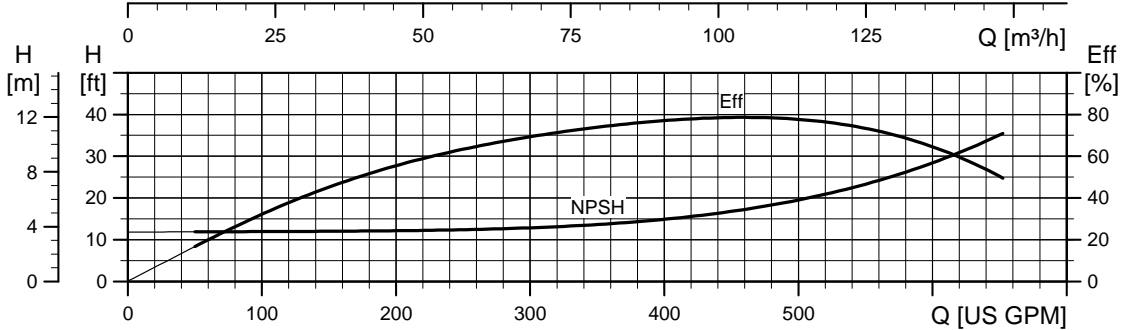
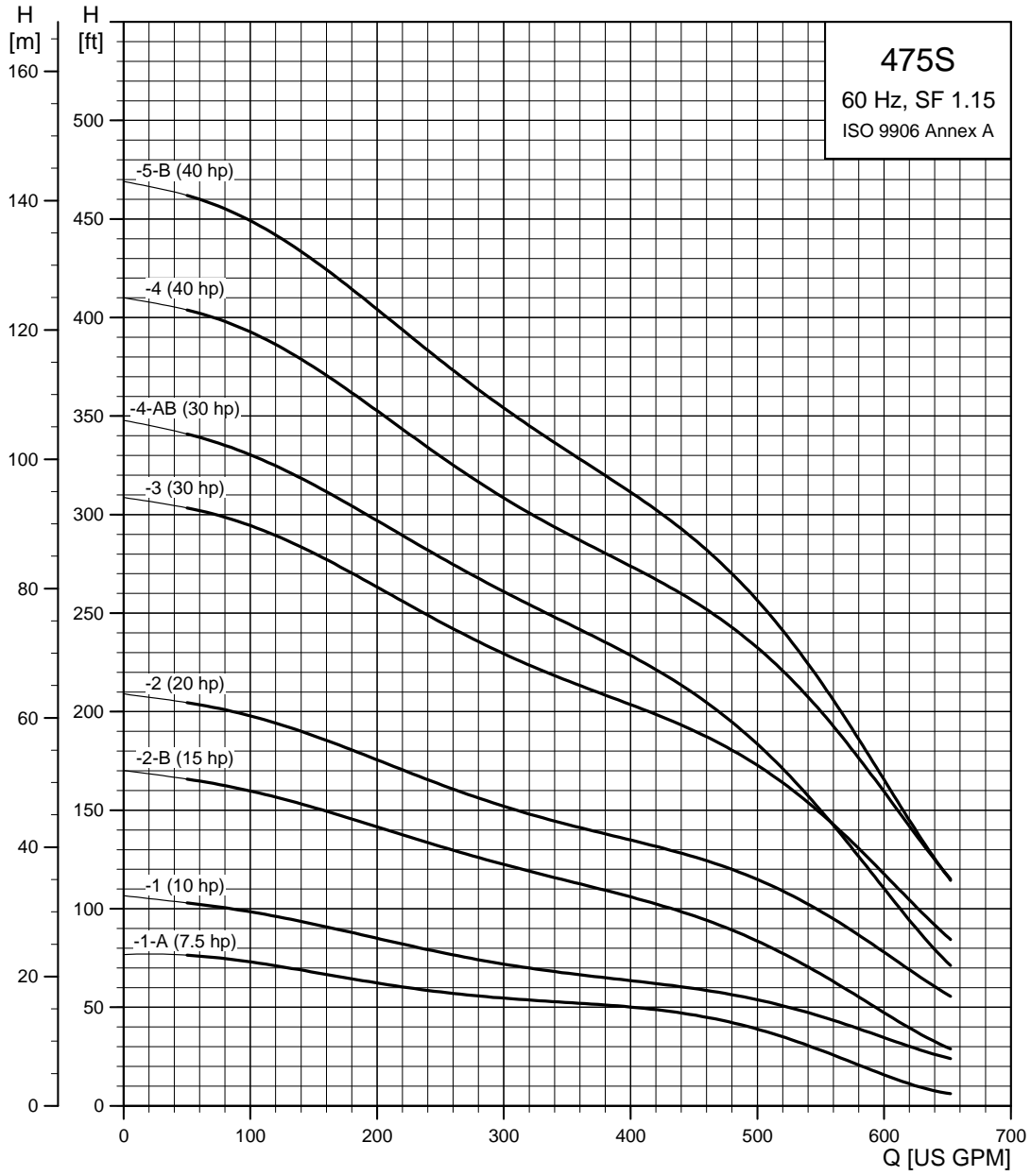

TM05 0255 2112

8" and larger wells - continued

SP 475S (475 gpm)

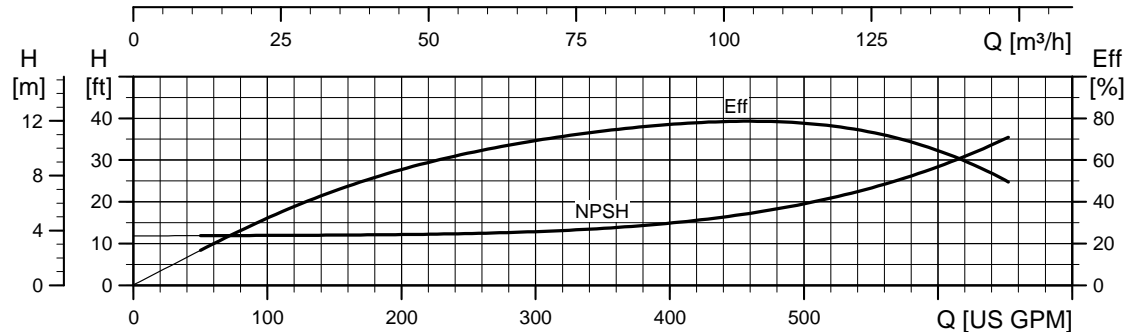
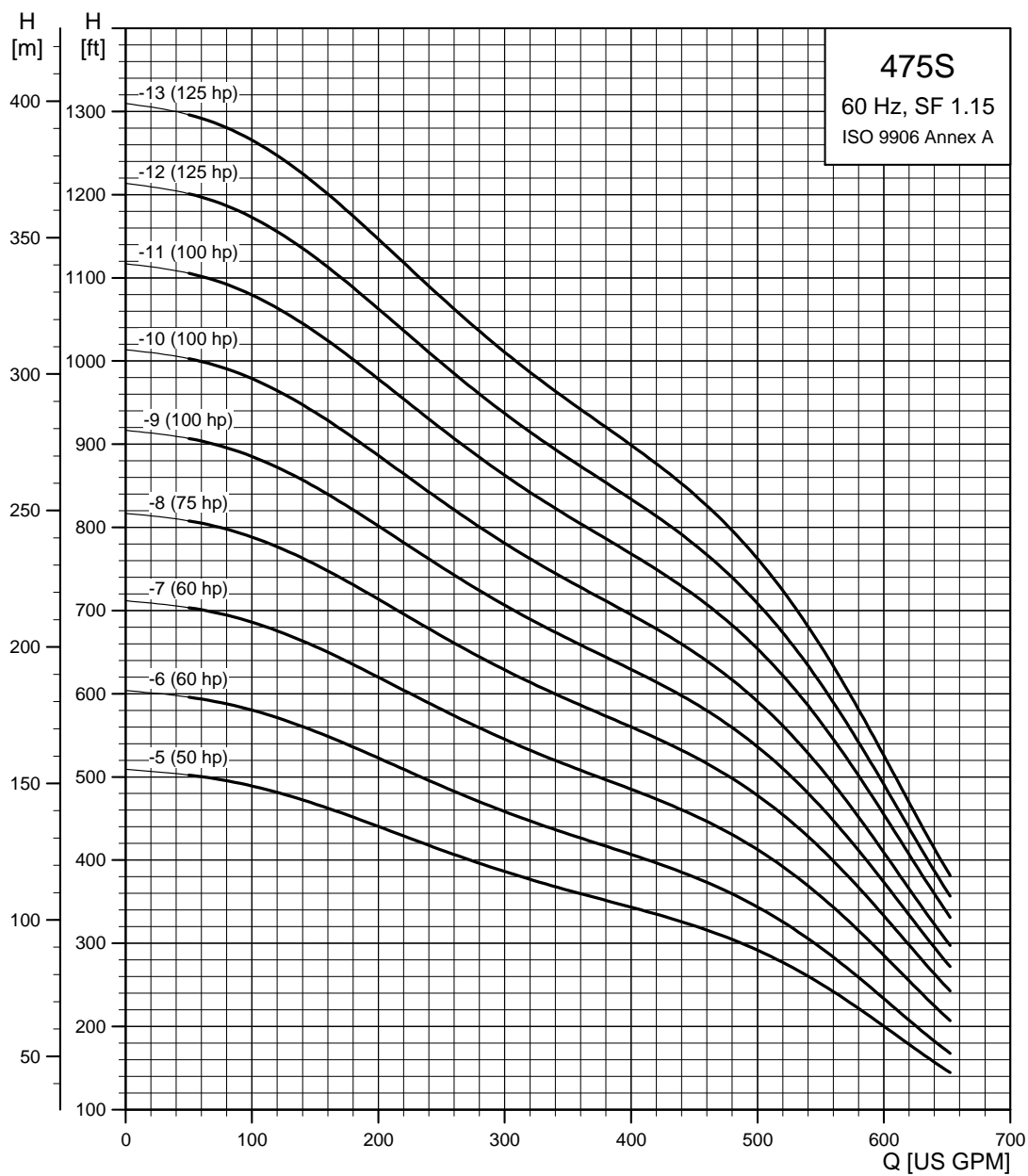

TM05 0256 2112

8" and larger wells - continued

SP 475S (475 gpm) pump power requirement (P2)

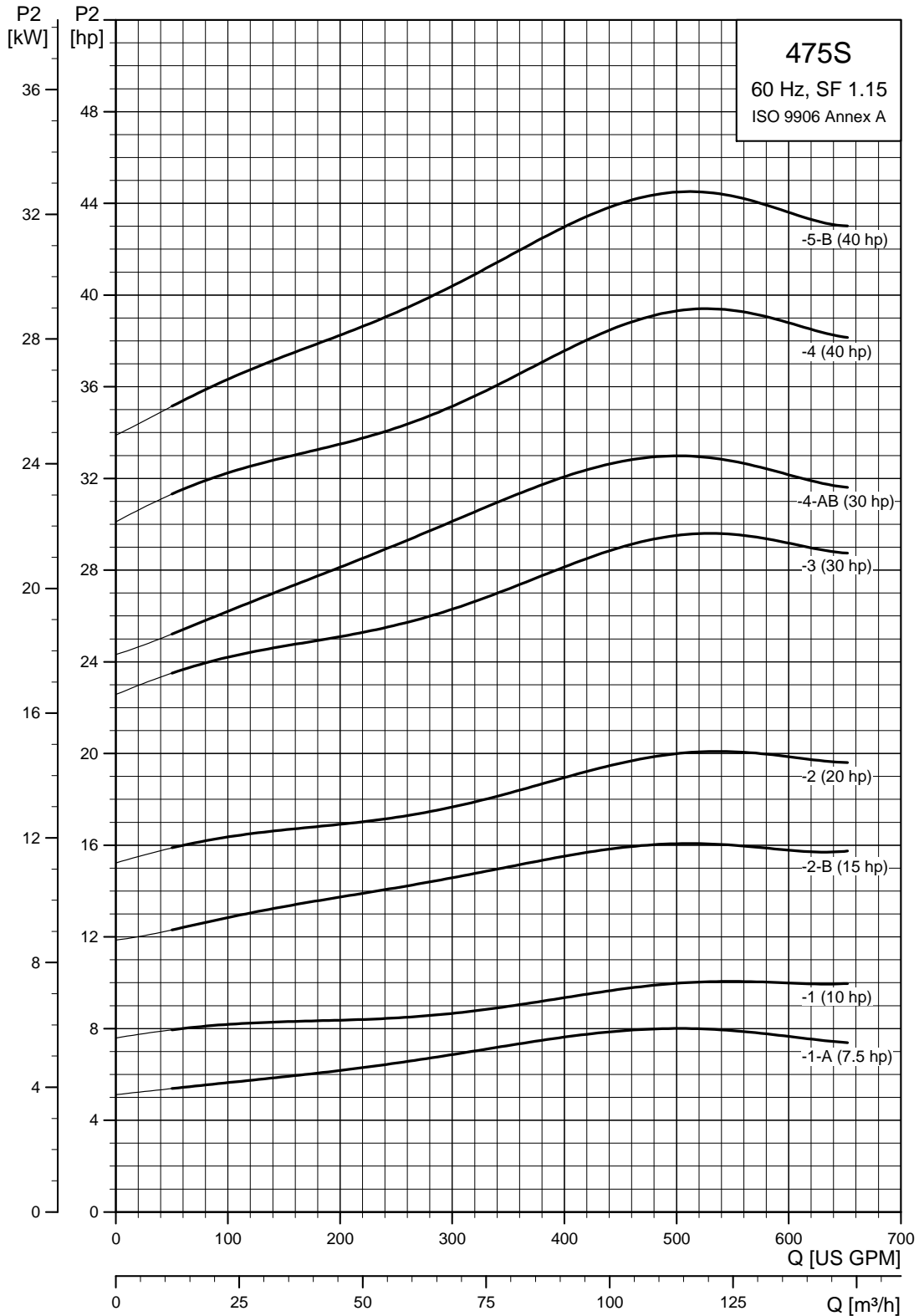

TM05 0257 1812

8" and larger wells - continued

SP 475S (475 gpm) pump power requirement (P2)

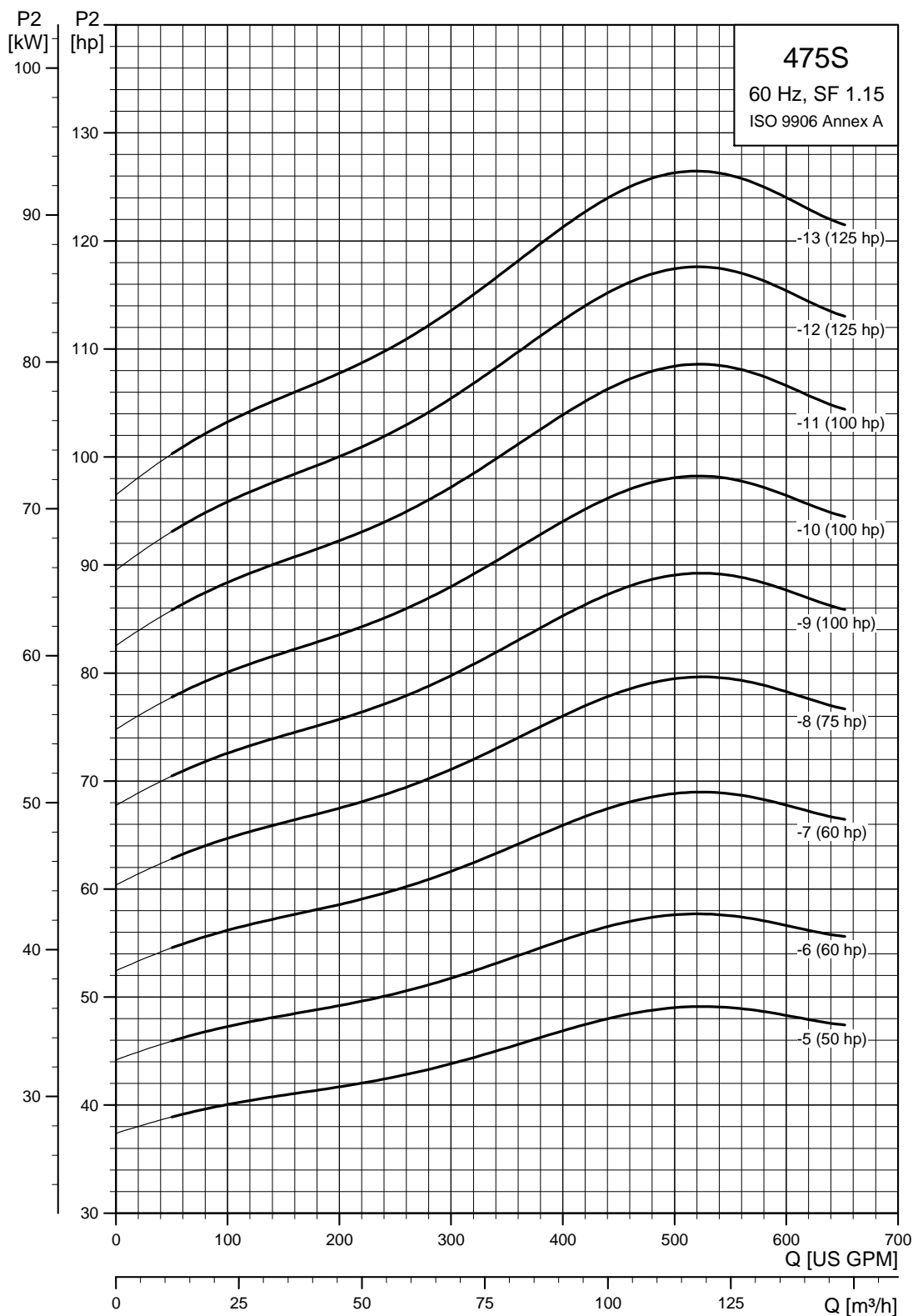

TM05 0258 1812

8" and larger wells - continued

SP 475S (475 gpm) / 6, 8 inch motors

Pump model	Nom. head [ft]	Ph	Volts [V]	Motor [Hp]	Dimensions					Net weight (complete) [lb]
					A [in. (mm)]	B [in. (mm)]	C [in. (mm)]	D [in. (mm)]	E [in. (mm)]	
475S - Motor dia. 6 inch, 60 Hz, rated flow 475 gpm (5" NPT)										
475S75-1A	42	3	230	7.5	▲ 46.58 (1183)	22.25 (565)	24.34 (618)	5.63 (143)	7.05 (179)	132.3
		3	460	7.5	▲ 46.58 (1183)	22.25 (565)	24.34 (618)	5.63 (143)	7.05 (179)	132.3
475S100-1	58	3	230	10	▲ 47.56 (1208)	23.23 (590)	24.34 (618)	5.63 (143)	7.05 (179)	132.3
		3	460	10	▲ 47.56 (1208)	23.23 (590)	24.34 (618)	5.63 (143)	7.05 (179)	132.3
475S150-2B	89	3	230	15	▲ 57.25 (1454)	27.88 (708)	29.38 (746)	5.63 (143)	7.05 (179)	170.1
		3	460	15	▲ 57.25 (1454)	27.88 (708)	29.38 (746)	5.63 (143)	7.05 (179)	170.1
475S200-2	117	3	230	20	▲ 60.20 (1529)	30.83 (783)	29.38 (746)	5.63 (143)	7.05 (179)	198.7
		3	460	20	▲ 60.20 (1529)	30.83 (783)	29.38 (746)	5.63 (143)	7.05 (179)	198.7
475S250-3A	166	3	230	25	▲ 67.41 (1712)	33.00 (838)	34.41 (874)	5.63 (143)	7.05 (179)	218.2
		3	460	25	▲ 67.41 (1712)	33.00 (838)	34.41 (874)	5.63 (143)	7.05 (179)	218.2
475S300-3	177	3	230	30	▲ 69.97 (1777)	35.56 (903)	34.41 (874)	5.63 (143)	7.05 (179)	233.6
		3	460	30	▲ 69.97 (1777)	35.56 (903)	34.41 (874)	5.63 (143)	7.05 (179)	233.6
475S300-4AB	168	3	230	30	▲ 75.00 (1905)	35.56 (903)	39.45 (1002)	5.63 (143)	7.05 (179)	239.9
		3	460	30	▲ 75.00 (1905)	35.56 (903)	39.45 (1002)	5.63 (143)	7.05 (179)	239.9
475S400-4	236	3	460	40	▲ 79.73 (2025)	40.28 (1023)	39.45 (1002)	5.63 (143)	7.05 (179)	268.5
475S - Motor dia. 6 inch, 60 Hz, rated flow 475 gpm (6" NPT)										
475S400-5B	268	3	460	40	▲ 84.77 (2153)	40.28 (1023)	44.49 (1130)	5.63 (143)	7.05 (179)	356.0
475S500-5	296	3	460	50	☼ 100.6 (2555)	56.11 (1425)	44.49 (1130)	5.67 (144)	7.05 (179)	384.0
475S500-6A	344	3	460	50	☼ 105.63 (2683)	56.11 (1425)	49.53 (1258)	5.67 (144)	7.05 (179)	385.0
475S600-6	355	3	460	60	*	-	50.08 (1272)	-	7.05 (179)	-
475S600-7	415	3	460	60	*	-	55.12 (1400)	-	7.05 (179)	-
475S - Motor dia. 8 inch, 60 Hz, rated flow 475 gpm (6" NPT)										
475S400-4	236	3	460	40	* 83.71 (2126)	43.71 (1110)	40.00 (1016)	7.56 (192)	8.08 (205)	406.5
475S400-5B	268	3	460	40	* 88.75 (2254)	43.71 (1110)	45.04 (1144)	7.56 (192)	8.08 (205)	-
475S500-5	296	3	460	50	* 90.71 (2304)	45.67 (1160)	45.04 (1144)	7.56 (192)	8.08 (205)	420.4
475S500-6A	344	3	460	50	* 95.75 (2432)	45.67 (1160)	50.08 (1272)	7.56 (192)	8.08 (205)	-
475S600-6	355	3	460	60	* 100.08 (2542)	50.00 (1270)	50.08 (1272)	7.56 (192)	8.08 (205)	476.0
475S600-7	415	3	460	60	* 105.12 (2670)	50.00 (1270)	55.12 (1400)	7.56 (192)	8.08 (205)	482.6
475S750-8	534	3	460	75	* 113.31 (2878)	53.15 (1350)	60.16 (1528)	7.56 (192)	8.08 (205)	524.4
475S1000-9	534	3	460	100	* 127.8 (3246)	62.60 (1590)	65.20 (1656)	7.56 (192)	8.08 (205)	631.0
475S1000-10	593	3	460	100	* 132.84 (3374)	62.60 (1590)	70.24 (1784)	7.56 (192)	8.08 (205)	637.6
475S1000-11	653	3	460	100	* 137.88 (3502)	62.60 (1590)	75.28 (1912)	7.56 (192)	8.08 (205)	644.3
475S1250-12	712	3	460	125	* 152.37 (3870)	72.05 (1830)	80.32 (2040)	7.56 (192)	8.08 (205)	754.1
475S1250-13	772	3	460	125	* 157.41 (3998)	72.05 (1830)	85.36 (2168)	7.56 (192)	8.08 (205)	760.7

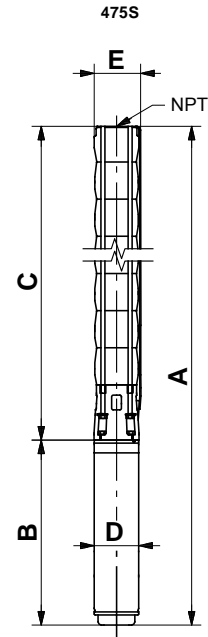

E = Maximum diameter of pump including cable guard and motor.

TM00 7872 2196

Notes:

Control box is required for 3-wire, single-phase applications. Data does not include control box. Performance conforms to ISO 9906. 1999 (E) Annex A. Minimum submergence is 2 feet.

- ▲ MS 6000C motor.
- ☼ Takes MMS 6 motor; not available as complete.
- * Takes MMS 8000 motor; not available as complete.

10" and larger wells SP 625S (625 gpm)

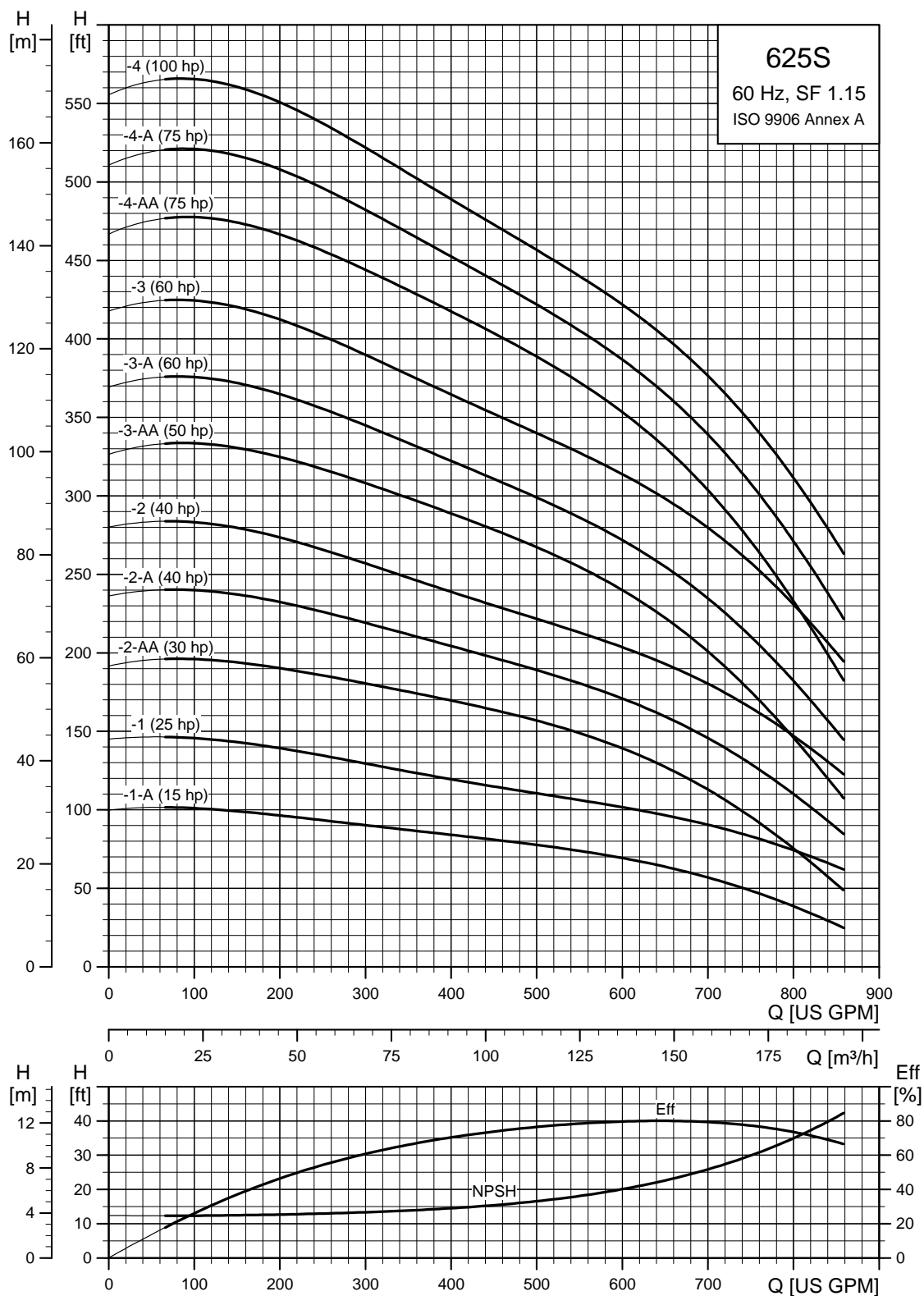

TM05 0259 1812

10" and larger wells - continued

SP 625S (625 gpm)

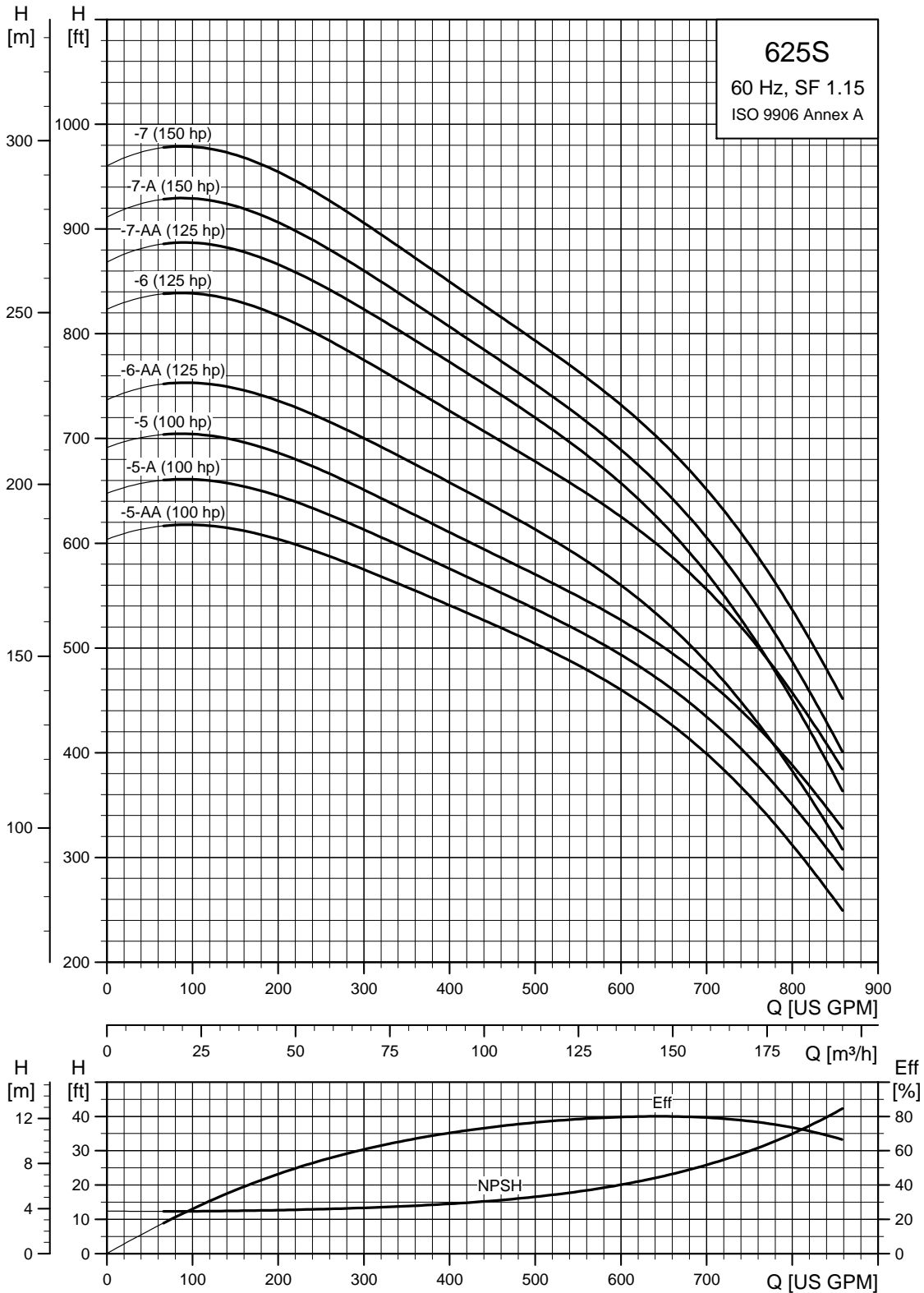

TM05 0260 1812

10" and larger wells - continued

SP 625S (625 gpm) pump power requirement (P2)

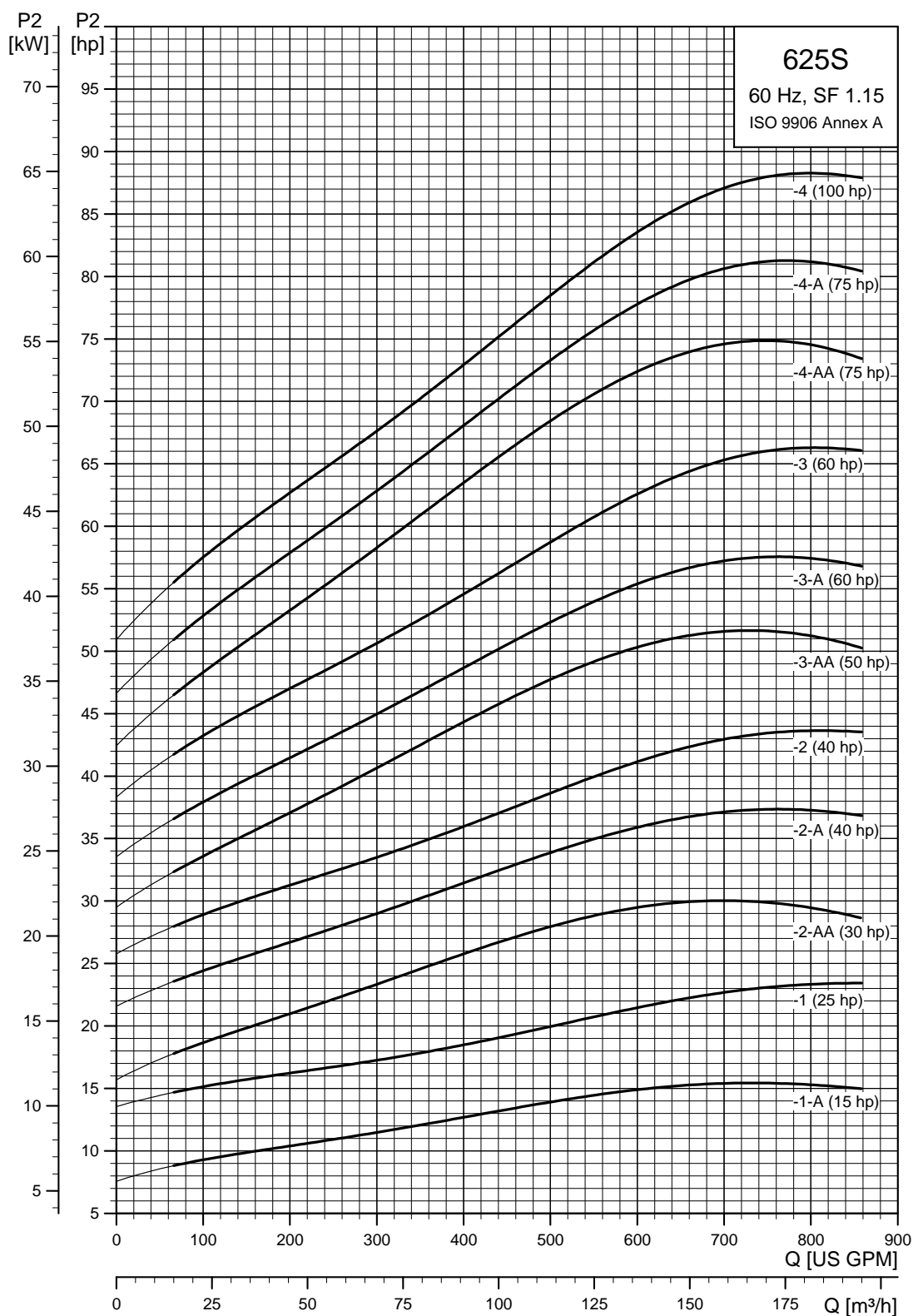

TM05 0261 1812

10" and larger wells - continued

SP 625S (625 gpm) pump power requirement (P2)

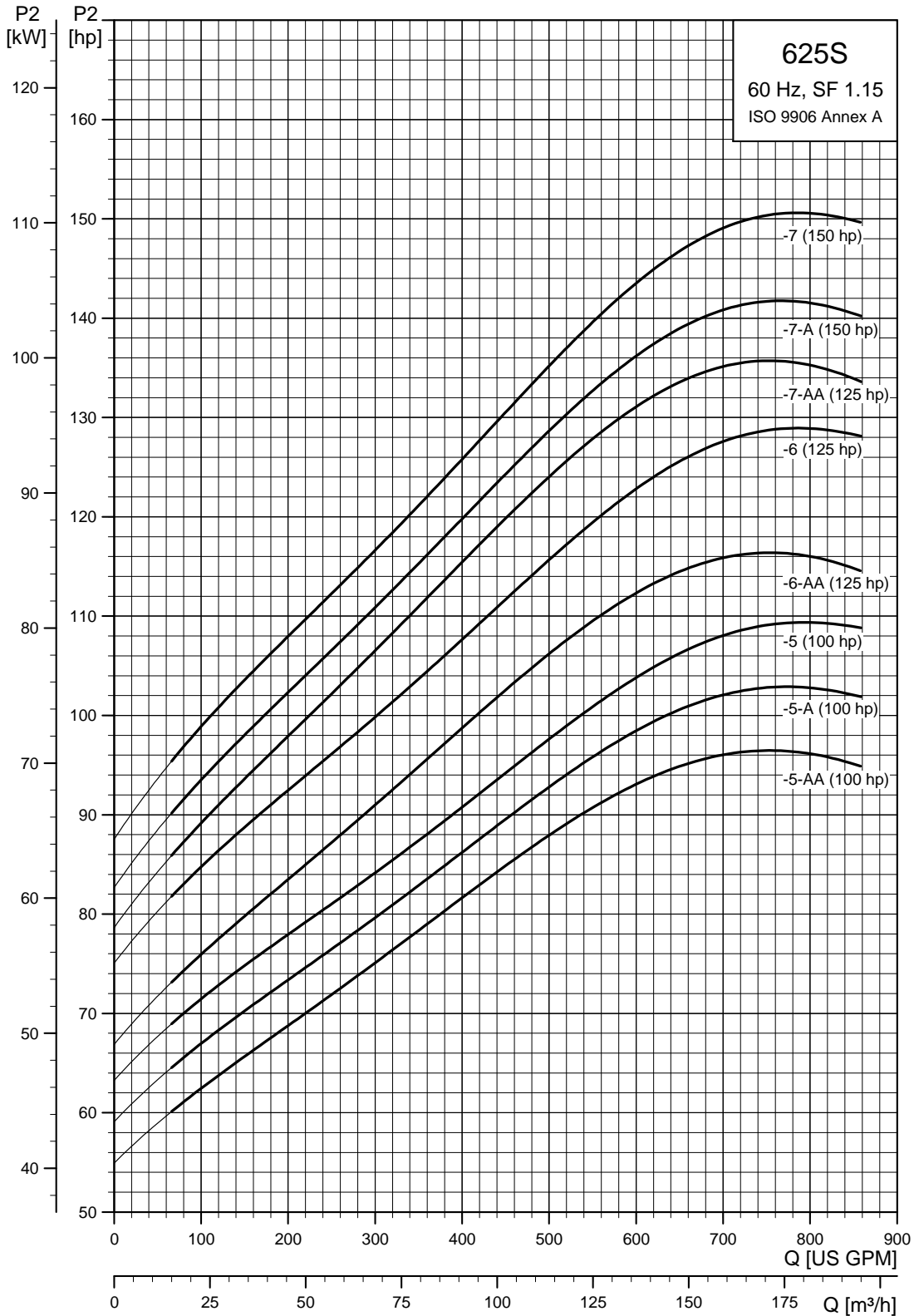

TM05 0262 1812

10" and larger wells - continued

SP 625S (625 gpm) / 6, 8 inch motors

Pump model	Nom. head [ft]	Ph	Volts [V]	Motor [Hp]	Dimensions					Net weight (complete) [lb]	
					A [in. (mm)]	B [in. (mm)]	C [in. (mm)]	D [in. (mm)]	E [in. (mm)]		
625S - Motor dia. 6 inch, 60 Hz, rated flow 625 gpm (6" NPT)											
625S150-1A	65	3	230	15	▲	53.51 (1359)	27.88 (708)	25.63 (651)	5.63 (143)	8.31 (211)	193.0
		3	460	15	▲	53.51 (1359)	27.88 (708)	25.63 (651)	5.63 (143)	8.31 (211)	193.0
625S250-1	95	3	230	25	▲	58.63 (1489)	33.00 (838)	25.63 (651)	5.63 (143)	8.31 (211)	189.9
		3	460	25	▲	58.63 (1489)	33.00 (838)	25.63 (651)	5.63 (143)	8.31 (211)	198.9
625S300-2AA	130	3	230	30	▲	67.33 (1710)	35.56 (903)	31.78 (807)	5.63 (143)	8.31 (211)	213.0
		3	460	30	▲	67.33 (1710)	35.56 (903)	31.78 (807)	5.63 (143)	8.31 (211)	222.3
625S400-2A	159	3	460	40	▲	72.05 (1830)	40.28 (1023)	31.78 (807)	5.63 (143)	8.31 (211)	333.8
625S400-2	194	3	460	40	▲	72.05 (1830)	40.28 (1023)	31.78 (807)	5.63 (143)	8.31 (211)	333.8
625S500-3AA	224	3	460	50	◆	94.02 (2388)	56.11 (1425)	37.94 (963)	5.63 (143)	8.31 (211)	376.4
625S600-3A	258	3	460	60	*	-	-	37.92 (963)	-	8.31 (211)	-
625S600-3	292	3	460	60	*	-	-	37.92 (963)	-	8.31 (211)	-
625S - Motor dia. 8 inch, 60 Hz, rated flow 625 gpm (6" NPT)											
625S400-2	194	3	460	40	*	76.03 (1931)	43.71 (1110)	32.33 (821)	7.56 (192)	8.39 (213)	409.4
625S500-3AA	224	3	460	50	*	83.59 (2123)	45.67 (1160)	37.92 (963)	7.56 (192)	8.39 (213)	444.6
625S600-3A	258	3	460	60	*	87.92 (2233)	50.00 (1270)	37.92 (963)	7.56 (192)	8.39 (213)	490.8
625S600-3	292	3	460	60	*	87.92 (2233)	50.00 (1270)	37.92 (963)	7.56 (192)	8.39 (213)	490.8
625S750-4AA	322	3	460	75	*	97.21 (2469)	53.15 (1350)	44.06 (1119)	7.56 (192)	8.39 (213)	534.8
625S750-4A	357	3	460	75	*	97.21 (2469)	53.15 (1350)	44.06 (1119)	7.56 (192)	8.39 (213)	534.8
625S1000-4	391	3	460	100	*	106.66 (2709)	62.60 (1590)	44.06 (1119)	7.56 (192)	8.39 (213)	633.8
625S1000-5AA	421	3	460	100	*	112.76 (2864)	62.60 (1590)	50.16 (1274)	7.56 (192)	8.39 (213)	649.3
625S1000-5A	455	3	460	100	*	112.76 (2864)	62.60 (1590)	50.16 (1274)	7.56 (192)	8.39 (213)	649.3
625S1000-5	490	3	460	100	*	112.76 (2864)	62.60 (1590)	50.16 (1274)	7.56 (192)	8.39 (213)	649.3
625S1250-6AA	520	3	460	125	*	128.31 (3259)	72.05 (1830)	56.26 (1429)	7.56 (192)	8.39 (213)	761.5
625S1250-6	554	3	460	125	*	128.31 (3259)	72.05 (1830)	56.26 (1429)	7.56 (192)	8.39 (213)	761.5
625S1250-7AA	618	3	460	125	*	134.45 (3415)	72.05 (1830)	62.41 (1585)	7.56 (192)	8.39 (213)	774.7
625S1500-7A	653	3	460	150	*	143.51 (3645)	81.11 (2060)	62.41 (1585)	7.56 (192)	8.39 (213)	884.7
625S1500-7	687	3	460	150	*	143.51 (3645)	81.11 (2060)	62.41 (1585)	7.56 (192)	8.39 (213)	884.7

Notes:

Control box is required for 3-wire, single-phase applications. Data does not include control box. Performance conforms to ISO 9906: 1999 (E) Annex A. Minimum submergence is 2 feet.

- ▲ MS 6000C motor.
- ◆ Takes MS 6000C motor; not available as complete.
- * Takes MMS 8000 motor; not available as complete.

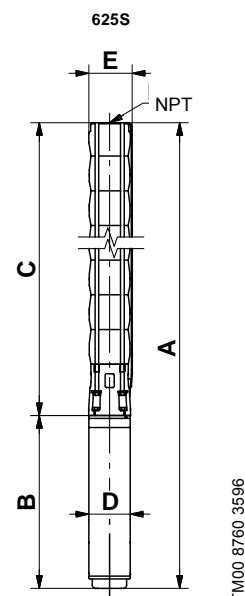

E = Maximum diameter of pump including cable guard and motor.

10" and larger wells - continued

SP 800S (800 gpm)

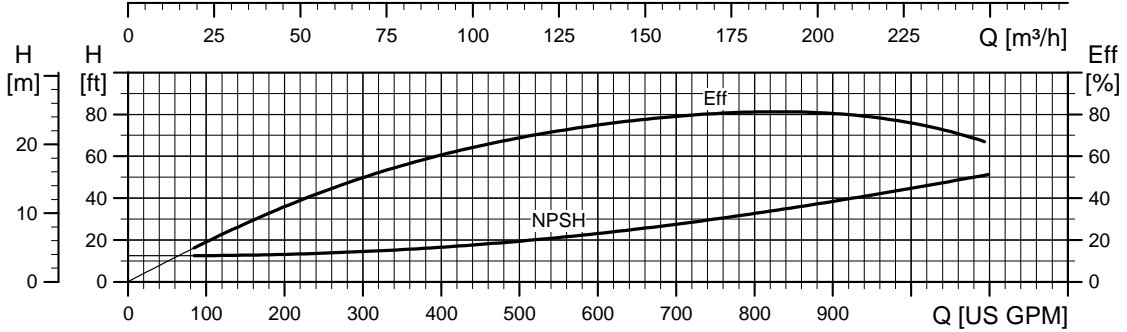
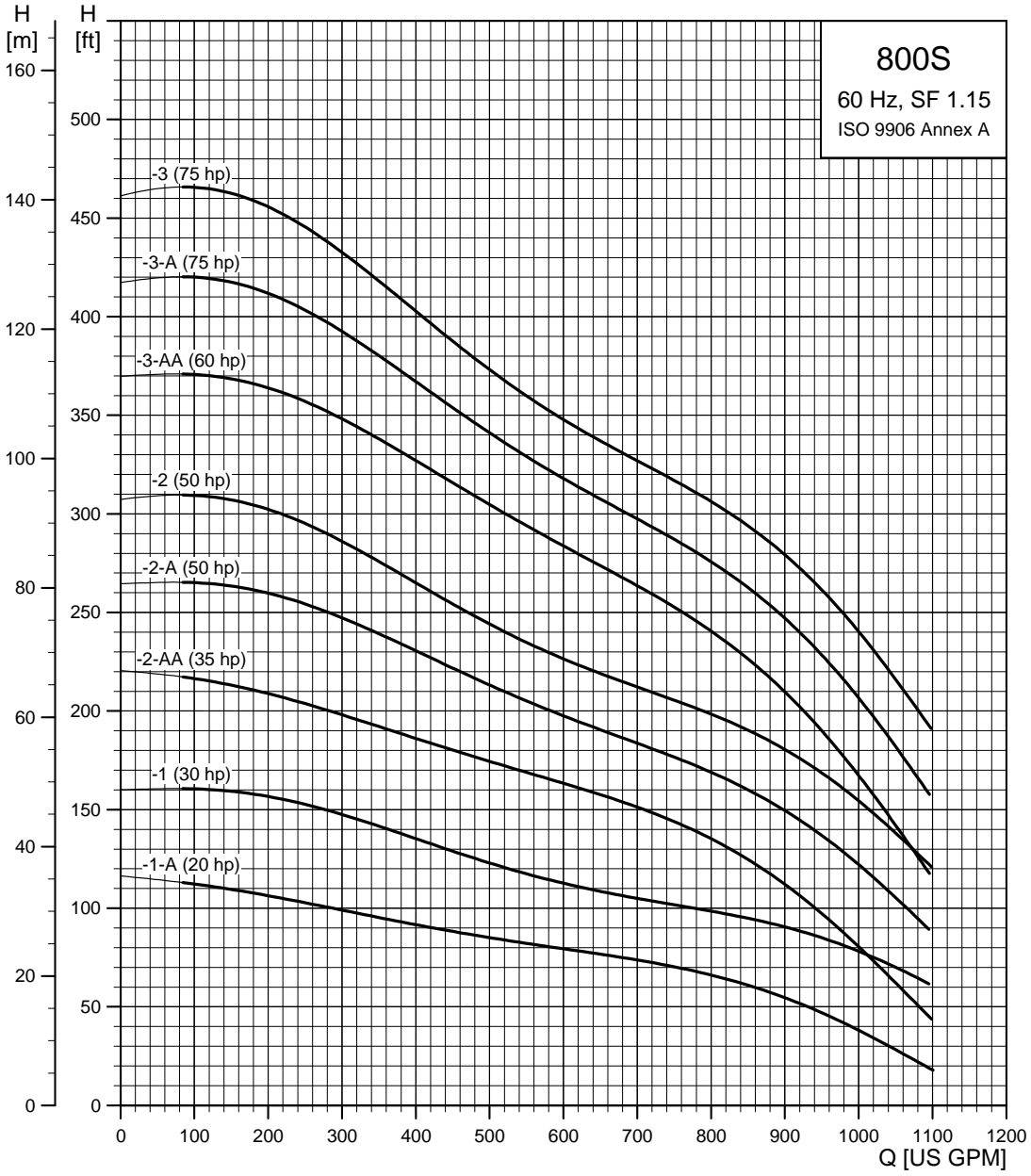

TM05 0263 1812

10" and larger wells - continued

SP 800S (800 gpm)

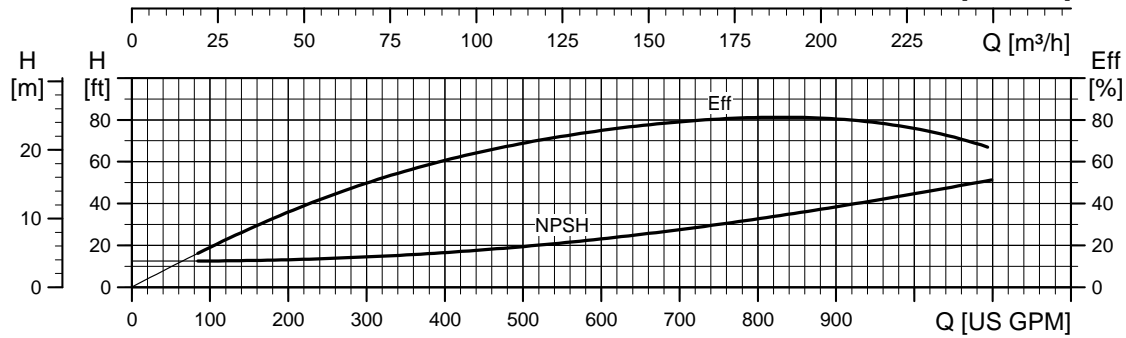
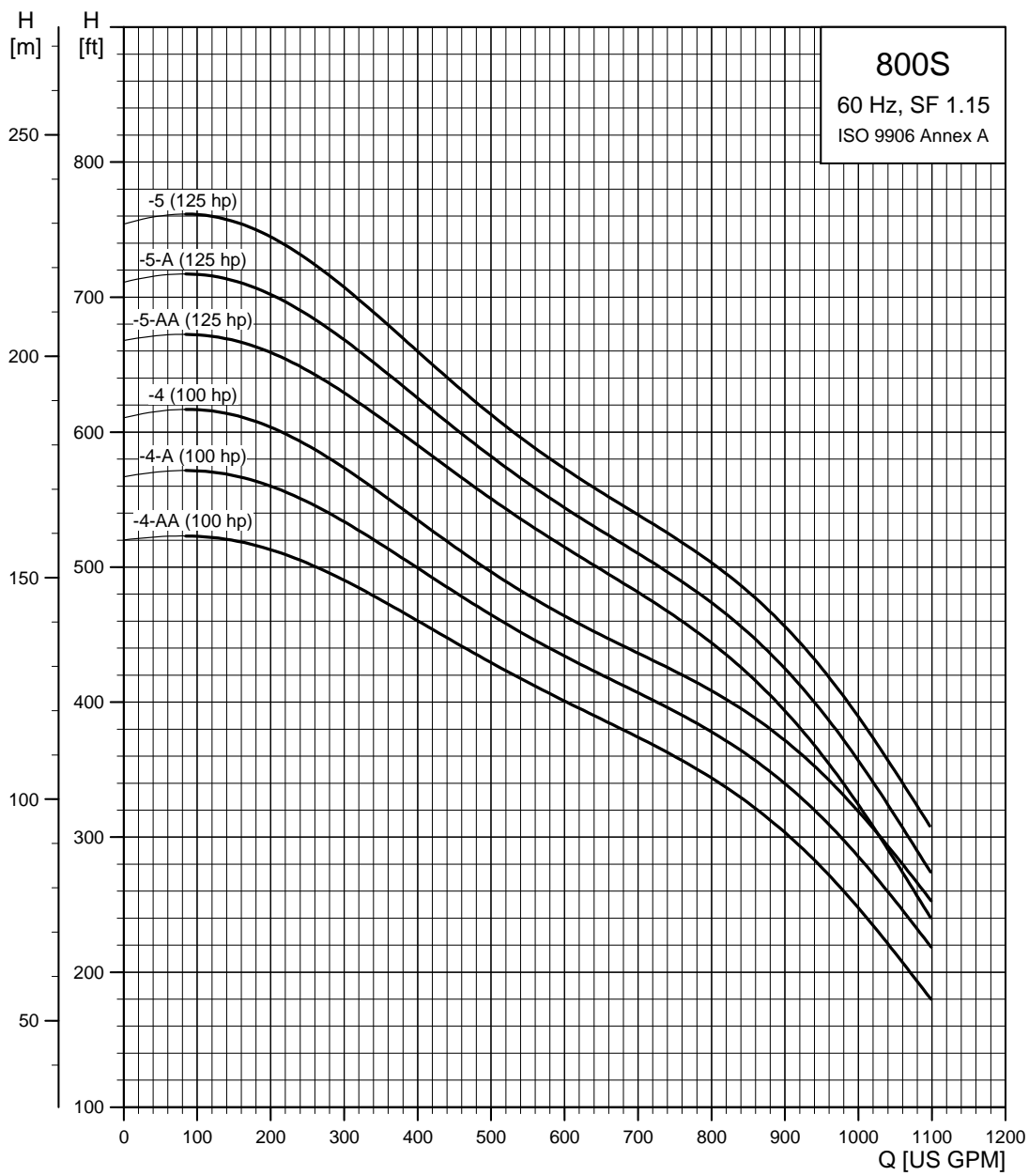

TM05 0264 1812

10" and larger wells - continued SP 800S (800 gpm) pump power requirement (P2)

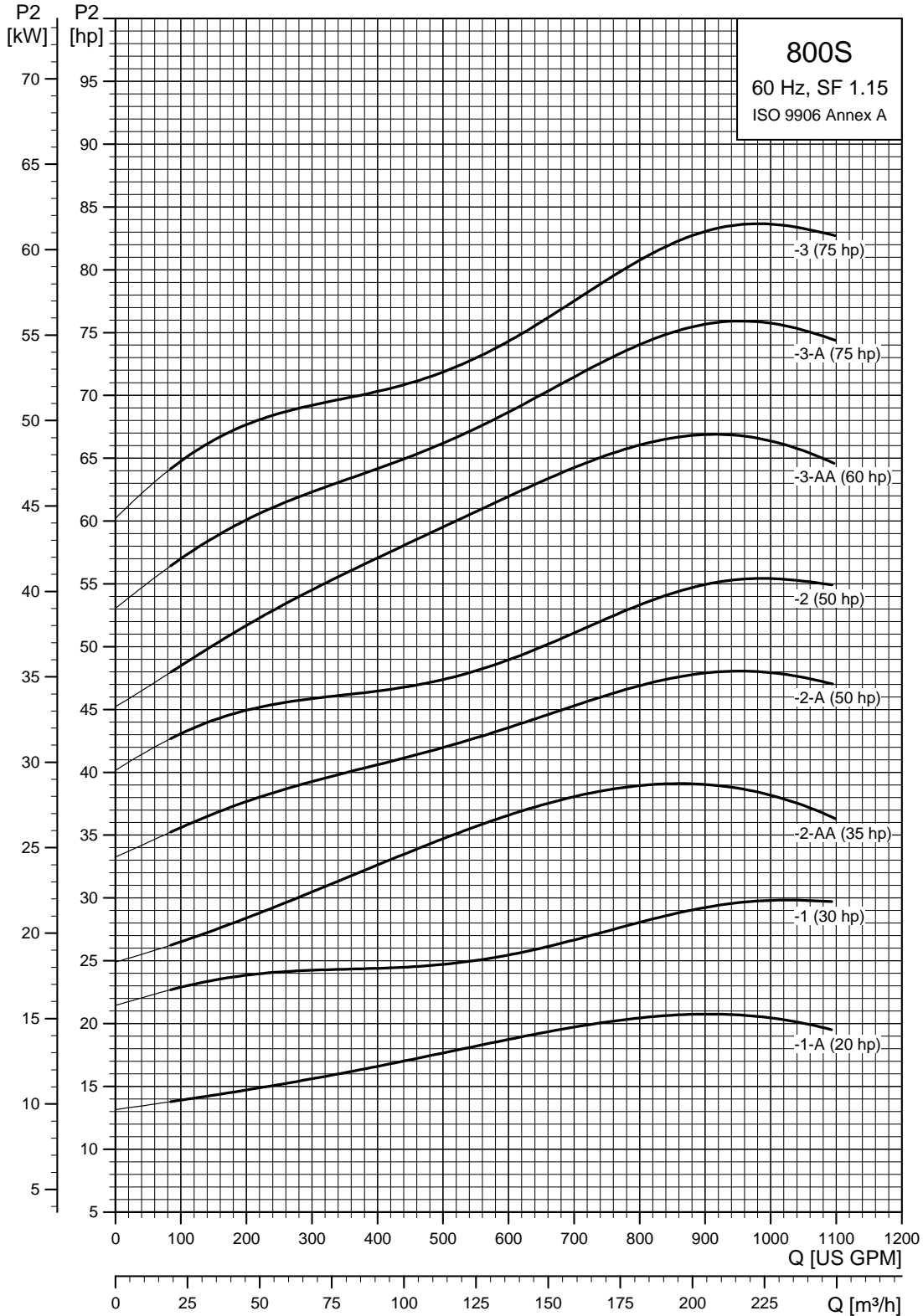

TM05 0265 1812

10" and larger wells - continued

SP 800S (800 gpm) pump power requirement (P2)

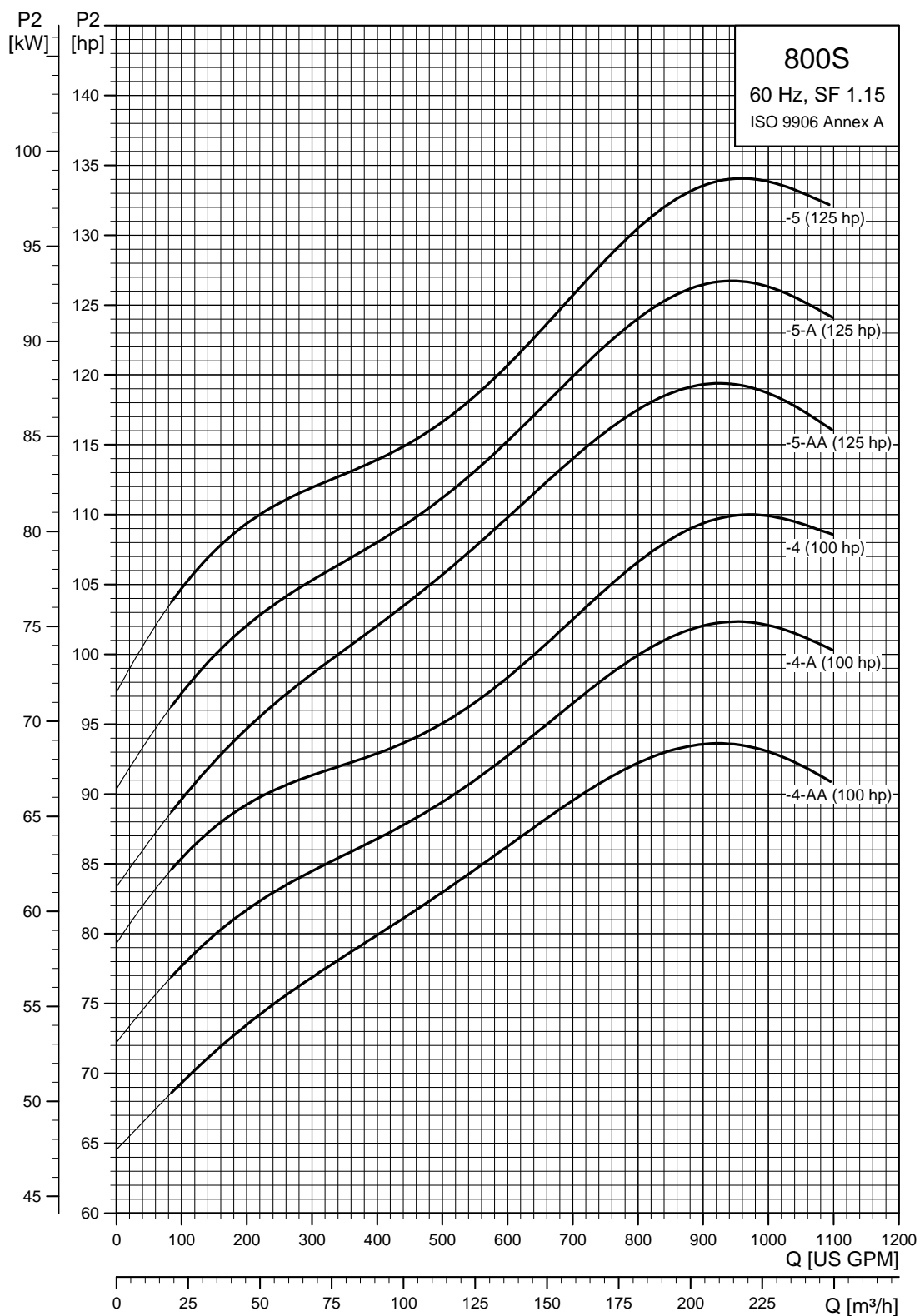

TM05 0266 1812

10" and larger wells - continued

SP 800S (800 gpm) / 6, 8 inch motors

Pump model	Nom. head [ft]	Ph	Volts [V]	Motor [Hp]	Dimensions					Net weight (complete) [lb]	
					A [in. (mm)]	B [in. (mm)]	C [in. (mm)]	D [in. (mm)]	E [in. (mm)]		
800S - Motor dia. 6 inch, 60 Hz, rated flow 800 gpm (6" NPT)											
800S200-1A	64	3	230	20	▲	56.50 (1435)	30.83 (783)	25.67 (652)	5.63 (143)	8.31 (211)	180.0
			460	20	▲	56.50 (1435)	30.83 (783)	25.67 (652)	5.63 (143)	8.31 (211)	180.0
800S300-1	96	3	230	30	▲	61.23 (1555)	35.56 (903)	25.67 (652)	5.63 (143)	8.31 (211)	202.5
			460	30	▲	61.23 (1555)	35.56 (903)	25.67 (652)	5.63 (143)	8.31 (211)	202.5
800S400-2AA	131	3	460	40	▲	72.05 (1830)	40.28 (1023)	31.78 (807)	5.63 (143)	8.31 (211)	257.4
800S500-2A	162	3	460	50	☼	88.00 (2235)	56.11 (1425)	31.87 (810)	7.56 (192)	8.39 (213)	363.2
800S500-2	194	3	460	50	☼	88.00 (2235)	56.11 (1425)	31.87 (810)	7.56 (192)	8.39 (213)	363.2
800S600-3AA	197	3	460	60	*	87.92 (2233)	50.00 (1270)	37.92 (963)	7.56 (192)	8.39 (213)	490.8
800S - Motor dia. 8 inch, 60 Hz, rated flow 800 gpm (6" NPT)											
800S400-2AA	131	3	460	40	*	75.48 (1917)	43.71 (1110)	31.78 (807)	7.56 (192)	8.39 (213)	409.4
800S500-2A	162	3	460	50	*	77.45 (1967)	45.67 (1160)	31.78 (807)	7.56 (192)	8.39 (213)	431.4
800S500-2	187	3	460	50	*	77.45 (1967)	45.67 (1160)	31.78 (807)	7.56 (192)	8.39 (213)	438.0
800S600-3AA	229	3	460	60	*	87.92 (2233)	50.00 (1270)	37.92 (963)	7.56 (192)	8.39 (213)	490.8
800S750-3A	260	3	460	75	*	91.07 (2313)	53.15 (1350)	37.92 (963)	7.56 (192)	8.39 (213)	523.8
800S750-3	292	3	460	75	*	91.07 (2313)	53.15 (1350)	37.92 (963)	7.56 (192)	8.39 (213)	523.8
800S1000-4AA	327	3	460	100	*	106.62 (2708)	62.60 (1590)	44.02 (1118)	7.56 (192)	8.39 (213)	633.8
800S1000-4A	358	3	460	100	*	106.62 (2708)	62.60 (1590)	44.02 (1118)	7.56 (192)	8.39 (213)	633.8
800S1000-4	389	3	460	100	*	106.62 (2708)	62.60 (1590)	44.02 (1118)	7.56 (192)	8.39 (213)	633.8
800S1250-5AA	426	3	460	125	*	122.21 (3104)	72.05 (1830)	50.16 (1274)	7.56 (192)	8.39 (213)	748.3
800S1250-5A	456	3	460	125	*	122.21 (3104)	72.05 (1830)	50.16 (1274)	7.56 (192)	8.39 (213)	748.3
800S1250-5	487	3	460	125	*	122.21 (3104)	72.05 (1830)	50.16 (1274)	7.56 (192)	8.39 (213)	746.6

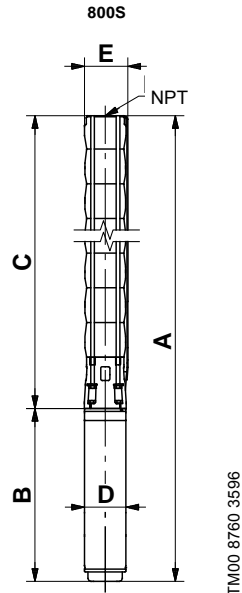

E = Maximum diameter of pump including cable guard and motor.

TM00 8760 3596

Notes:

Control box is required for 3-wire, single-phase applications. Data does not include control box. Performance conforms to ISO 9906, 1999 (E) Annex A. Minimum submergence is 2 feet.

- ▲ MS 6000C motor.
- ☼ Takes MMS 6 motor; not available as complete.
- * Takes MMS 8000 motor; not available as complete.

10" and larger wells - continued

SP 1100S (1100 gpm)

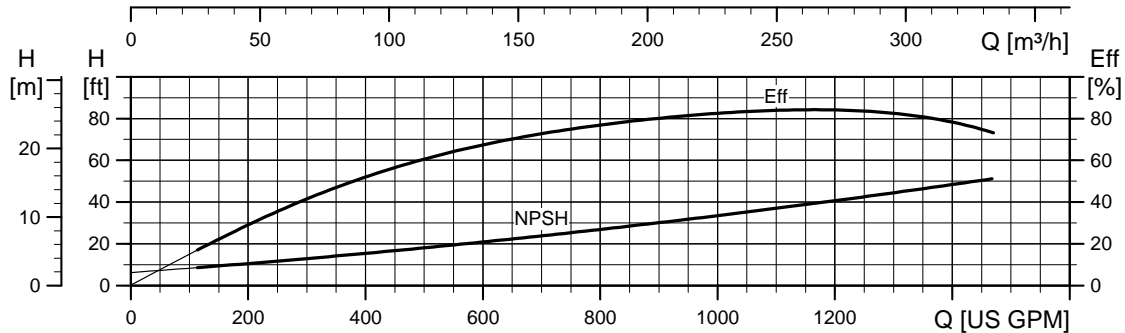
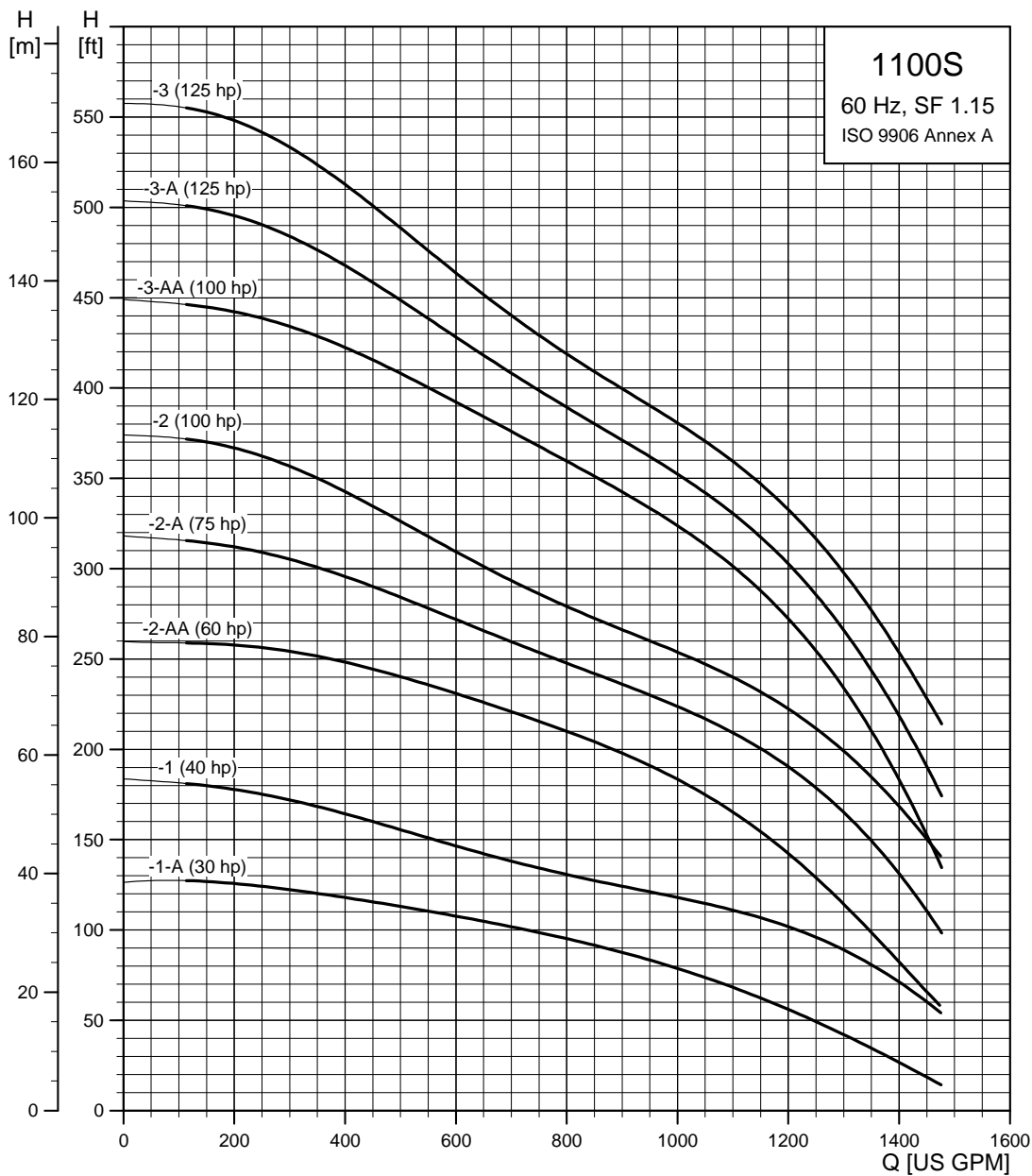

TM05 0267 1812

10" and larger wells - continued SP 1100S (1100 gpm)

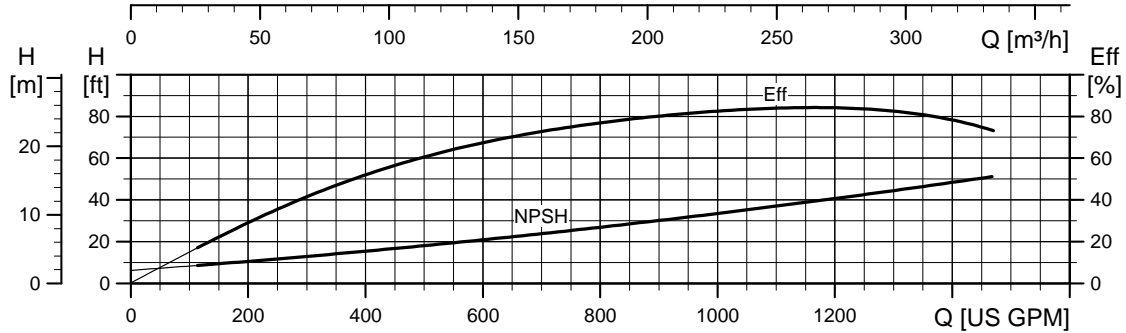
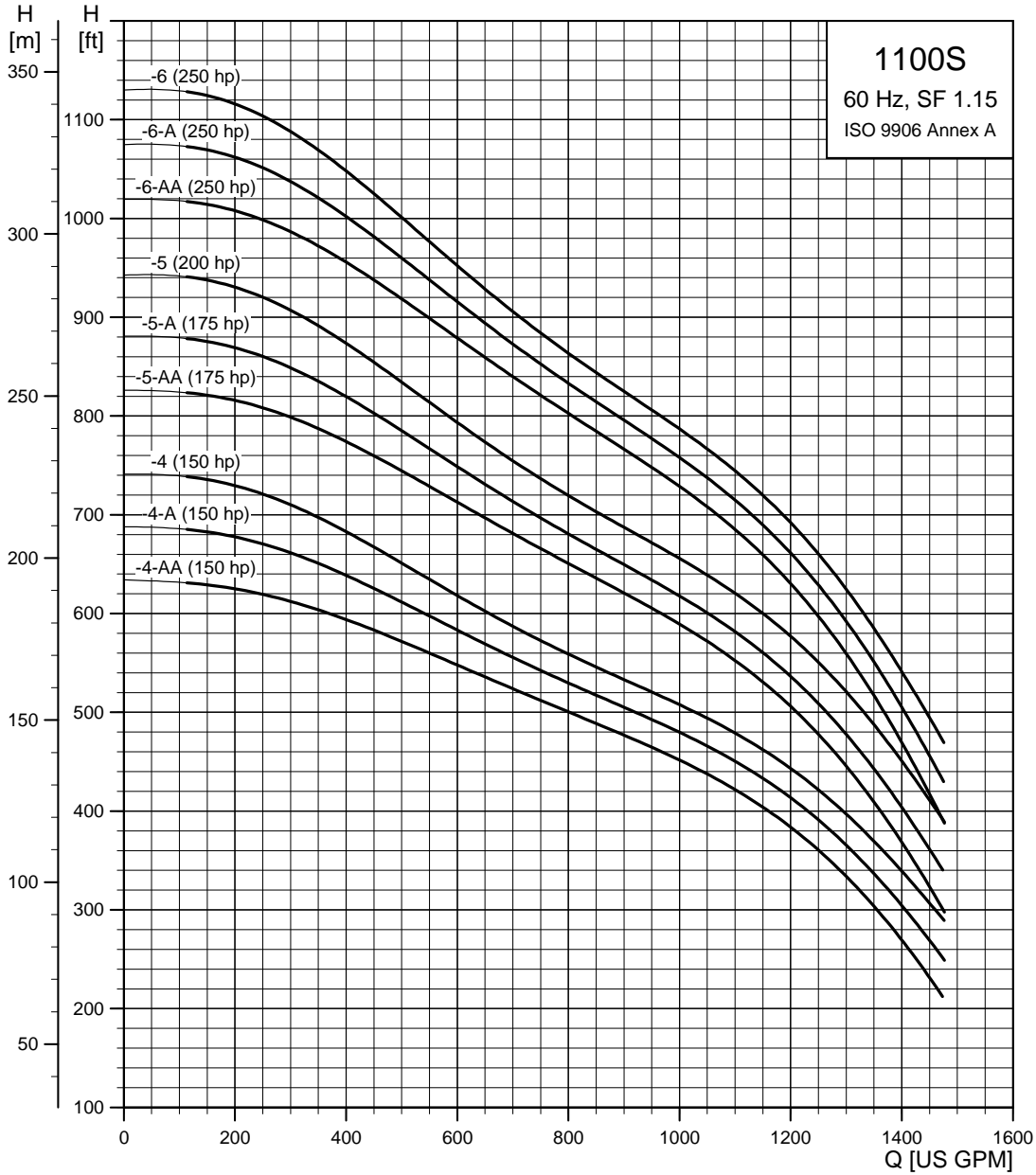

TM05 0268 1812

10" and larger wells - continued

SP 1100S (1100 gpm) pump power requirement (P2)

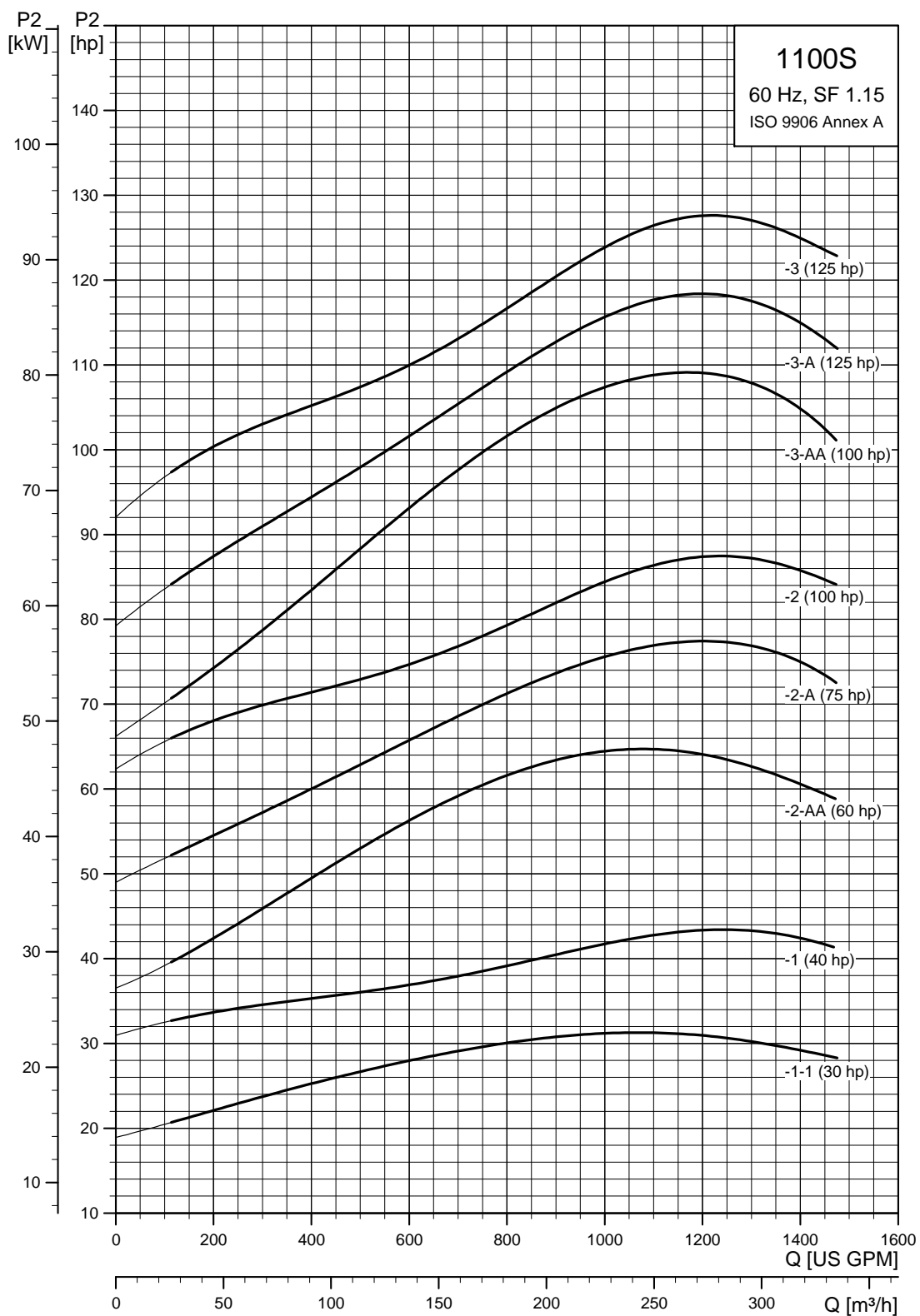

TM05 0269 1812

10" and larger wells - continued

SP 1100S (1100 gpm) pump power requirement (P2)

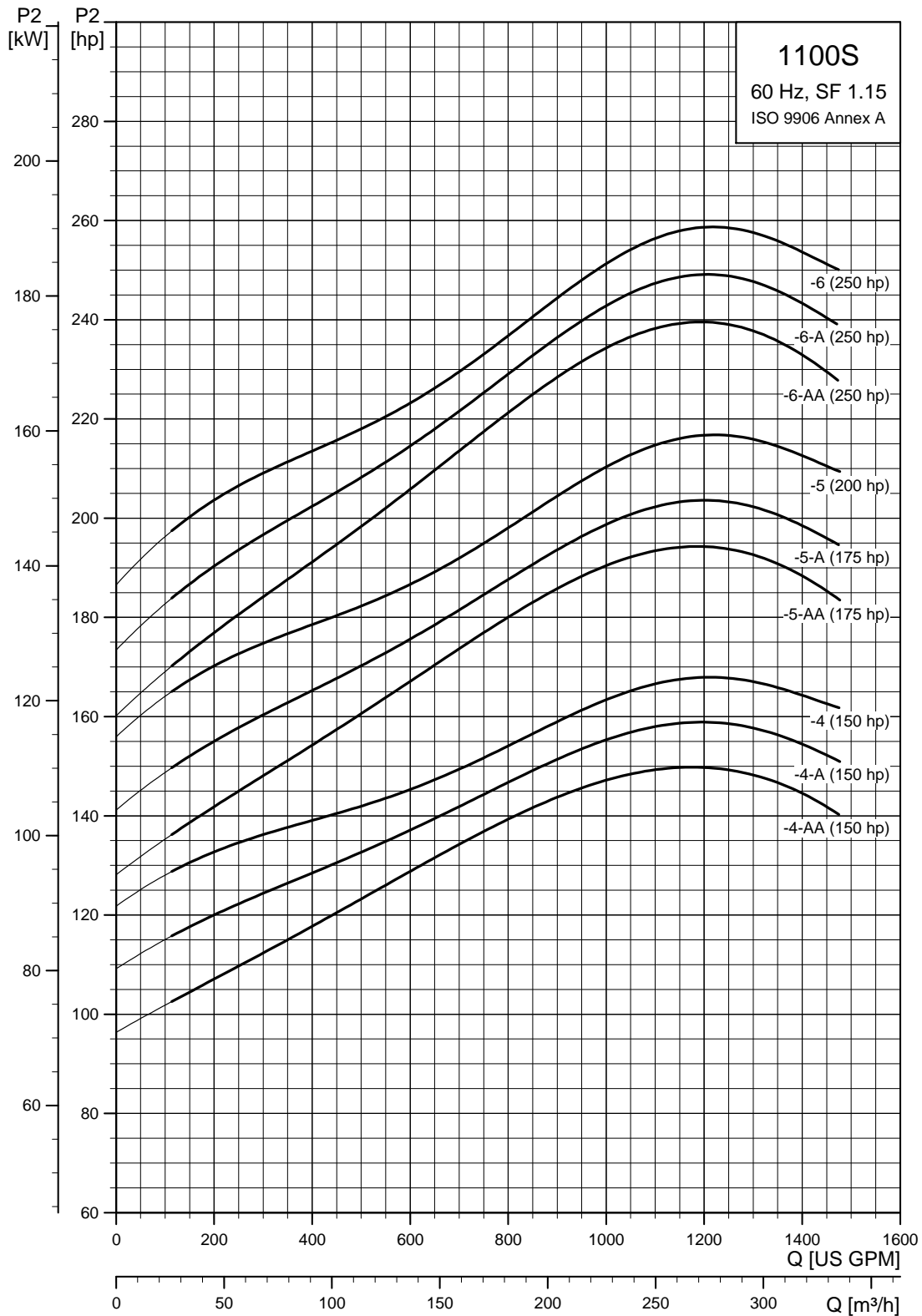

TM05 0270 1812

10" and larger wells - continued

SP 1100S (1100 gpm) / 6, 8, 10 inch motors

Pump model	Nom. head [ft]	Ph	Volts [V]	Motor [Hp]	Dimensions					Net weight (complete) [lb]
					A [in. (mm)]	B [in. (mm)]	C [in. (mm)]	D [in. (mm)]	E [in. (mm)]	
1100S - Motor dia. 6 inch, 60 Hz, rated flow 1100 gpm (6" NPT)										
1100S300-1A	67	3	230	30 ▲	66.66 (1693)	35.56 (903)	31.11 (790)	5.63 (143)	9.30 (236)	261.0
		3	460	30 ▲	66.66 (1693)	35.56 (903)	31.11 (790)	5.63 (143)	9.30 (236)	261.0
1100S400-1	108	3	460	40 ▲	71.38 (1813)	40.28 (1023)	31.11 (790)	5.63 (143)	9.30 (236)	290.6
1100S600-2AA	155	3	460	60 †	-	-	38.04 (966)	-	9.30 (236)	-
1100S - Motor dia. 8 inch, 60 Hz, rated flow 1100 gpm (6" NPT)										
1100S400-1	108	3	460	40 *	74.81 (1900)	43.71 (1110)	31.11 (790)	7.56 (192)	9.41 (239)	407.2
1100S600-2AA	155	3	460	60 *	88.04 (2236)	50.00 (1270)	38.04 (966)	7.56 (192)	9.41 (239)	501.8
1100S750-2A	197	3	460	75 *	91.19 (2316)	53.15 (1350)	38.04 (966)	7.56 (192)	9.41 (239)	534.8
1100S1000-2	227	3	460	100 *	100.63 (2556)	62.60 (1590)	38.04 (966)	7.56 (192)	9.41 (239)	633.8
1100S1000-3AA	286	3	460	100 *	107.56 (2732)	62.60 (1590)	44.97 (1142)	7.56 (192)	9.41 (239)	655.9
1100S1250-3A	316	3	460	125 *	117.01 (2972)	72.05 (1830)	44.97 (1142)	7.56 (192)	9.41 (239)	757.1
1100S1250-3	346	3	460	125 *	117.01 (2972)	72.05 (1830)	44.97 (1142)	7.56 (192)	9.41 (239)	757.1
1100S1500-4AA	405	3	460	150 *	133.00 (3378)	81.11 (2060)	51.89 (1318)	7.56 (192)	9.41 (239)	889.1
1100S1500-4A	435	3	460	150 *	133.00 (3378)	81.11 (2060)	51.89 (1318)	7.56 (192)	9.41 (239)	889.1
1100S1500-4	465	3	460	150 *	133.00 (3378)	81.11 (2060)	51.89 (1318)	7.56 (192)	9.41 (239)	889.1
1100S1750-5AA	524	3	460	175 *	-	-	58.82 (1494)	-	9.41 (239)	-
1100S1750-5A	554	3	460	175 *	-	-	58.82 (1494)	-	9.41 (239)	-
1100S2000-5	584	3	460	200 *	-	-	58.82 (1494)	-	9.41 (239)	-
1100S - Motor dia. 10 inch, 60 Hz, rated flow 1100 gpm (6" NPT)										
1100S1750-5AA	524	3	460	175 †	132.45 (3364)	73.63 (1870)	58.82 (1494)	9.34 (237)	9.85 (250)	1142.2
1100S1750-5A -1800	554	3	460	175 †	132.45 (3364)	73.63 (1870)	58.82 (1494)	9.34 (237)	9.85 (250)	1137.0
1100S2000-5	584	3	460	200 †	140.32 (3564)	81.5 (2070)	58.82 (1494)	9.34 (237)	9.85 (250)	1285.2
1100S2500-6AA -2600	703	3	460	250 †	160.24 (4070)	94.49 (2400)	65.75 (1670)	9.34 (237)	9.85 (250)	1478.0
1100S2500-6A-2600	673	3	460	250 †	160.24 (4070)	94.49 (2400)	65.75 (1670)	9.34 (237)	9.85 (250)	1483.2
1100S2500-6-2600	703	3	460	250 †	160.24 (4070)	94.49 (2400)	65.75 (1670)	9.34 (237)	9.85 (250)	1483.2

Notes:

Control box is required for 3-wire, single-phase applications. Data does not include control box. Performance conforms to ISO 9906: 1999 (E) Annex A. Minimum submergence is 2 feet.

- ▲ MS 6000C motor.
- * Takes MMS 8000 motor; not available as complete.
- † Takes MMS 10000 motor; not available as complete.

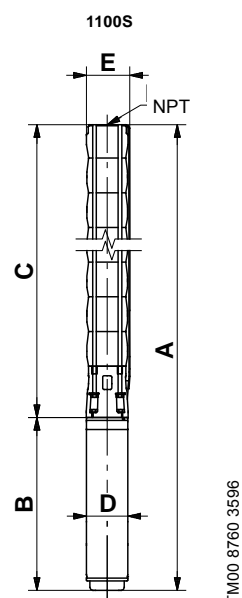

E = Maximum diameter of pump including cable guard and motor.

7. Electrical data

Grundfos submersible pump motors - 60 Hz											
Hp	Ph	Volt [V]	S.F.	Circuit breaker or fuses		Amperage		Full load		Max. thrust [lb]	Product number
				Std.	Delay	Start [A]	Max. [A]	Eff. [%]	PF [%]		
4-inch, single-phase, 2-wire motors (control box not required)											
.5	1	115	1.60	35	15	55.0	12.0	62	76	900	96465574
.5	1	230	1.60	15	7	34.5	6.0	62	76	900	96465616
.75	1	230	1.50	20	9	40.5	8.4	62	75	900	96465618
1	1	230	1.40	25	12	48.4	9.8	63	82	900	96465620
1.5	1	230	1.30	35	15	62.0	13.1	64	85	900	96465622
4-inch, single-phase, 3-wire motors											
.5	1	115	1.60	35	15	42.5	12.0	61	76	900	96023039
.5	1	230	1.60	15	7	21.5	6.0	62	76	900	96465606
.75	1	230	1.50	20	9	31.4	8.4	62	75	900	96465608
1	1	230	1.40	25	12	37.0	9.8	63	82	900	96465610
1.5	1	230	1.30	35	15	45.9	11.6	69	89	900	96465612
2	1	230	1.25	35	20	57.0	13.2	72	86	1500	96449947
3	1	230	1.15	45	30	77.0	17.0	74	93	1500	96449948
5	1	230	1.15	70	45	110.0	27.5	77	92	1500	96449949
4-inch, three-phase motors											
1.5	3	230	1.30	15	8	40.3	7.3	75	72	900	96465629
1.5	3	460	1.30	10	4	20.1	3.7	75	72	900	96465651
1.5	3	575	1.30	10	4	16.1	2.9	75	72	900	96785912
2	3	230	1.25	20	10	48	8.7	76	75	900	96465630
2	3	460	1.25	10	5	24	4.4	76	75	900	96465652
2	3	575	1.25	10	4	19.2	3.5	76	75	900	96785917
3	3	230	1.15	30	15	56	12.2	77	75	1500	96405801
3	3	460	1.15	15	7	28	6.1	77	75	1500	96405810
3	3	575	1.15	15	6	22	4.8	77	75	1500	96405815
5	3	230	1.15	40	25	108	19.8	80	82	1500	96405802
5	3	460	1.15	20	12	54	9.9	80	82	1500	96405811
5	3	575	1.15	15	9	54	7.9	80	82	1500	96405816
7.5	3	230	1.15	60	30	130	25.0	81	82	1500	96405805
7.5	3	460	1.15	35	15	67	13.2	81	82	1500	96405814
7.5	3	575	1.15	30	15	67	10.6	81	82	1500	96405819
10	3	460	1.15	50	30	90	18	81	80	1500	96440318
6-inch, three-phase motors											
7.5	3	208-230	1.15	65	40	114 - 130	23.4 - 27.5	81	85 - 84	6070	96166181
7.5	3	460	1.15	30	17	68	13.2	81	85	6070	96166161
7.5	3	575	1.15	30	17	51	10.2	81	85	6070	96166141
10	3	208-230	1.15	90	50	126 - 142	30.0 - 37.5	82	86 - 84	6070	96166182
10	3	460	1.15	40	25	75	17.4	82	85	6070	96166162
10	3	575	1.15	40	25	56.5	13.4	82	85	6070	96166142
15	3	208-230	1.15	130	75	198 - 224	44.5 - 53.5	83	86 - 84	6070	96166184
15	3	460	1.15	60	35	112	25	83	84	6070	96166164
15	3	575	1.15	60	35	84	19.4	83	84	6070	96166144
20	3	208-230	1.15	175	100	310 - 350	57.5 - 71.5	84	86 - 84	6070	96166186
20	3	460	1.15	80	45	186	33.5	84	84	6070	96166166
20	3	575	1.15	80	45	144	26	84	84	6070	96166146
25	3	208-230	1.15	200	125	395 - 445	71 - 87	84	87 - 84	6070	96166187
25	3	460	1.15	100	60	236	41	84	84	6070	96166167
25	3	575	1.15	100	60	180	32	84	84	6070	96166147
30	3	208-230	1.15	250	150	445 - 500	81 - 104	84	87 - 84	6070	96166188
30	3	460	1.15	125	70	265	48	85	85	6070	96166168
30	3	575	1.15	125	70	194	37	85	85	6070	96166148
40	3	460	1.15	170	90	330	65	85	84	6070	96166170
40	3	575	1.15	170	90	250	49.5	85	84	6070	96166150
50	3	460	1.15	225	125	405	73.0	83	83	6182	96879560
8-inch, three-phase motors											
40	3	460	1.15	175	100	380	55.7	83	85	13000	96023204
50	3	460	1.15	225	125	550	67.8	84	85	13000	96023205
60	3	460	1.15	250	150	640	80.4	86	85	13000	96023206
75	3	460	1.15	300	175	580	97.4	86	86	13000	96023207
100	3	460	1.15	400	225	570	130.4	87	86	13000	96023208
125	3	460	1.15	500	300	600	160.0	87	87	13000	96023209
150	3	460	1.15	600	350	580	191.3	86	87	13000	96023210
10-inch, three-phase motors											
175	3	460	1.15	700	400	570	230.4	88	85	13000	96937300
200	3	460	1.15	800	500	620	265.2	87	82	13000	96937302
250	3	460	1.15	1100	600	610	352.2	87	79	13000	96937316

Other motor manufacturers: For Hitachi motors refer to the Hitachi submersible motors application maintenance manual; for Franklin motors refer to the Franklin submersible motors application maintenance manual.

8. Accessories

MP 204

The MP 204 is an electronic motor protector, designed for the protection of an asynchronous motor or a pump.

The motor protector consists of:

- a cabinet incorporating transformers and electronics
- a control panel with operating buttons and display for reading of data.

The MP 204 operates with two sets of limits:

- a set of warning limits and
- a set of trip limits.

If one or more of the warning limits are exceeded, the motor continues to run, but the warnings will appear in the MP 204 display.

Some values only have a warning limit.

The warning can also be read out by means of the Grundfos GO.

If one of the trip limits is exceeded, the trip relay will stop the motor. At the same time, the signal relay is operating to indicate that the limit has been exceeded.

Applications

The MP 204 can be used as a stand-alone motor protector.

The MP 204 can be monitored via a Grundfos GENIbus.

The power supply to the MP 204 is in parallel with the supply to the motor. Motor currents up to 120 A are passed directly through the MP 204. The MP 204 protects the motor primarily by measuring the motor current by means of a true RMS measurement. The MP 204 disconnects the contactor if, for example, the current exceeds the preset value.

Secondarily, the motor is protected via temperature measuring by a Tempcon sensor, a Pt100/Pt1000 sensor and a PTC sensor/thermal switch.

The MP 204 is designed for single- and three-phase motors. In single-phase motors, the starting and run capacitors are also measured. $\cos \varphi$ is measured in both single- and three-phase systems.

Benefits

The MP 204 offers these benefits:

- Suitable for both single- and three-phase motors
- Dry-running protection
- Overload protection
- Very high accuracy
- Made for submersible pumps.

Many monitoring options

The MP 204 monitors the following parameters:

- Insulation resistance before start-up
- Temperature (Tempcon, Pt sensor and PTC/thermal switch)
- Overload/underload
- Overvoltage/undervoltage
- Phase sequence
- Phase failure
- Power factor
- Power consumption
- Harmonic distortion
- Operating hours and number of starts.



Fig. 20 MP 204

Five sizes of single-turn transformers, 120-999 A.

Note: Monitoring of motor temperature with Tempcon sensor is not possible when single-turn transformers are used.



Fig. 21 Single-turn transformers

TM03 1471 2205

TM03 2033 3505

Product numbers

Product	Description	Product number
MP 204	Motor protector	96079927
MI 202	Dongle for iPhone 4/4s, iPad, or iPod touch (30 pin connector compatible)	9804637
MI 204	Dongle for iPhone 5/5s, iPad, or iPod touch (lightening connector compatible)	98424092
MI 301	Universal Bluetooth dongle for Android or iOS device	98046408
MI 204	MI204 Kit with MI204 dongle, Apple iPod 5, sleeve and cover	98612711

Functions

- Phase-sequence monitoring
- Indication of current or temperature (user selection)
- Indication of temperature in °F or °C (user selection)
- 4-digit, 7-segment display
- Setting and status reading with the Grundfos GO.
- Setting and status reading via the GENIbus.

Tripping conditions

- Overload
- Underload (dry running)
- Temperature (Tempcon sensor, PTC/thermal switch and Pt sensor)
- Phase failure
- Phase sequence
- Overvoltage
- Undervoltage
- Power factor (cos ϕ)
- Current unbalance.

Warnings

- Overload
 - Underload
 - Temperature (Tempcon and Pt sensor)
 - Overvoltage
 - Undervoltage
 - Power factor (cos ϕ)
- Note:** In connection with single- and three-phase connection.
- Run capacitor (single-phase operation)
 - Starting capacitor (single-phase operation)
 - Loss of communication in network
 - Harmonic distortion.

Learning function

- Phase sequence (three-phase operation)
- Run capacitor (single-phase operation)
- Starting capacitor (single-phase operation)
- Identification and measurement of Pt100/Pt1000 sensor circuit.

External current transformers

When fitted with external current transformers, the MP 204 unit can handle currents from 120 to 999 A. Grundfos can supply approved current transformers from stock (200/5A, 300/5A, 500/5A, 750/5A, 1000/5A).

Grundfos GO

The GO from Grundfos allows for wireless infrared remote control of your MP 204 unit.

With the GO, you get access to a full range of options such as factory setting adjustment, service and fault finding.

Ready for bus communication

The MP 204 allows for monitoring and communication via GENIbus, a Grundfos-designed bus for exchange of pump data, alarms, status information, and setpoints. This enables users to connect the MP 204 to, for instance, SCADA systems.

Technical data - MP 204

Enclosure class	IP20
Ambient temperature	-4 °F to +140 °F (-20 °C to +60 °C)
Relative air humidity	99 %
Voltage range	100-480 VAC
Current range	3-999 A
Frequency	50 to 60 Hz
IEC trip class	1-45
Special Grundfos trip class	0.1 to 30 s
Voltage variation	- 25 %/+ 15 % of nominal voltage
Approvals	EN 60947, EN 60335, UL/CSA 508
Marking	CE, cUL, C-tick
Consumption	Max. 5 W
Plastic type	Black PC / ABS

	Measuring range	Accuracy	Resolution
Current without external current transformers	3-120 A	± 1 %	0.1 A
Current with external current transformers	120-999 A	± 1 %	1 A
Phase-to-phase voltage	80-610 VAC	± 1 %	1 V
Frequency	47-63 Hz	± 1 %	0.5 Hz
Power	0-1 MW	± 2 %	1 W
Power factor	0 - 0.99	± 2 %	0.01
Energy consumption	0-4 x 10 ⁹ kWh	± 5 %	1 kWh

IO 112	Description	Product number
	<p>The IO 112 is a measuring module and a 1-channel protection unit for use in connection with the MP 204 motor protection unit. The module can be used for protection of pump against other factors than the electrical conditions, for instance dry-running. It can also be used as a stand-alone protection module.</p> <p>The IO 112 interface has three inputs for measured values one potentiometer for setting of limits indicator lights indicating the</p> <ul style="list-style-type: none"> • measured value of the input • value of the limit set • alarm source • pump status. <p>Electrical data:</p> <ul style="list-style-type: none"> • Supply voltage: 24 VAC ± 10 % 50/60 Hz or 24 VDC ± 10 % • Supply current: Min. 2.4 A; max. 8 A • Power consumption: Max. 5 W • Ambient temperature: -13 °F to +149 °F (-25 °C to +65 °C) • Enclosure class: IP20 	96651601

Control functions

This table describes the protection provided by MP 204.

Control parameters	Function	Problem	Advantages
Temperature	<p>MS The motor temperature is measured by means of the built-in Tempcon temperature transmitter and a signal is sent to MP 204 via the phase leads. In MP 204 the measured temperature is compared with the factory-set value of 167 °F (75 °C).</p> <p>MMS The motor temperature is measured by means of the Pt100. The signal is sent to the MP 204 where the measured temperature is compared with the factory-set value. Temperature protection requires a submersible motor with a Pt100. The motor temperature must be monitored during variable frequency drive operation.</p>	Overload, frequent starts/stops, operation against blocked discharge pipe, insufficient flow velocity past the motor.	Longer motor life, safe operating conditions, service indication.
Overvoltage/undervoltage	If the set trip value is exceeded, the motor will stop.	The installation is close to a transformer. The mains do not absorb load variations.	Important installation parameter, possibility of improving operating conditions.
Overload	The motor power input is measured on each of the three phases. The registered power input is an average of these three values. If the factory-set value is exceeded, the motor will stop.	Incorrect sizing of pump/motor, voltage supply failure, defective cable, blocking, wear or corrosion.	Longer pump life, safe operating conditions, service indication.
Underload (dry running)	The motor power input is measured on each of the three phases. The registered power input is an average of these three values. If the average value is lower than the factory-set value, the motor will stop.	Pump exposed to dry running or underload, for example caused by wear.	Traditional dry-running protection is no longer necessary, no extra cables.
Current unbalance	The power input of the motor is measured on each of the three phases.	Mains load is uneven, incipient motor defect, phase voltages diverging.	Motor protection against overload, service indication.
Phase sequence	MP 204 and motor are installed so that the phase sequence corresponds to correct direction of rotation. MP 204 monitors changes in the phase sequence.	Two phases are wrongly connected.	Ensures correct pump performance.
Phase failure	MP 204 checks the phases connected, phase failure will cause an alarm.	Phase failure	Indication of phase failure, and alarm.

Grundfos GO remote app and Grundfos GO CAPS

Grundfos GO is the mobile tool box for professional users on the go. The Grundfos GO app can be used to establish wireless connection to Grundfos products. Grundfos GO gives you intuitive handheld pump control, and full access to all the Grundfos Online tools on the go. Grundfos GO consists of two Apps: GO Remote and GO CAPS. It is available from Apple App Store and Google Play.

The Grundfos GO app must be used in conjunction with one of these MI (mobile interface) devices:

- Grundfos MI 202
- Grundfos MI 204
- Grundfos MI 301.

The mobile interfaces are modules with built-in IR and radio communication.

The Grundfos product must support either IR communication or radio communication.

Grundfos GO Remote

Grundfos GO Remote works with all our E-pumps and communicates both using both radio and infrared technology. It provides easy-to-follow tips and guidance as well as live pump data feeds.

To communicate with the pumps, special hardware (Mobile Interfaces) from Grundfos is required. The Grundfos GO Remote app can be downloaded for free for both Apple iOS and Android devices.

While connected to a Grundfos product, the following features are available:

- Product dashboard - gives the user a quick overview of the connected product
- Status data - monitor status data from the Grundfos product
- Alarms and warnings - see detailed alarm information with timestamps
- Configuration/commissioning
- Create installation report in pdf format
- Read / write profiles - copy configuration from one product to another
- Supports 28 languages

Grundfos GO CAPS

GO CAPS works online and supports all the basic CAPS functionalities. It is available for Apple iOS devices only, and is free to download. Features:

- Search product by: Number, Name or QR code
- Size a product (Heating, Air-conditioning, Pressure boosting & Wastewater)
- Catalog
- Replace product
- Compare products
- Product view
- Projects
- Favorites
- Supports 11 languages

MI 202 and MI 204

The MI 202 and MI 204 are add-on modules for Apple devices. For Apple iPod touch 4 and iPhone 4 and 4S, use the MI 202. For Apple products with Lightning connector, e.g. iPhone 5 and iPhone 6, use the MI 204.

Note: "Made for iPod, iPhone" means that an electronic accessory has been designed to connect specifically to iPod or iPhone and has been certified by the developer to meet Apple performance standards. Apple is not responsible for the operation of this device or its compliance with safety and regulatory standards. Please note that the use of this accessory with iPod may affect wireless performance.



Fig. 22 MI 202 and MI 204

MI 301

The MI 301 is a module that connects to an Android or iOS-based smart device via Bluetooth. The MI 301 has a rechargeable Li-ion battery and must be charged separately.



Fig. 23 MI 301

Supported devices

The smart devices listed below have been tested and are supported by Grundfos GO.

Make	Model	MI 202	MI 204	MI 301
Apple	iPod touch 4G	•		•
	iPod touch 5G		•	•
	iPhone 4, 4S	•		•
	iPhone 5, 5S, 5C, 6, 6 Plus		•	•
	iPad, iPad Mini		•	•
Asus	Nexus 7			•
	Transformer TF101, TF300			•
Google	Galaxy Nexus, Nexus 4, Nexus 10			•
HTC	Desire S, One S, Sensation			•
Motorola	Xoom2, Moto X (XT1053)			•
Samsung	Galaxy S II, Galaxy S III			•
	Galaxy tab 2 7.0			•
Sony	Xperia Arc, Arc S, Xperia Tipo, Xperia V			•

Note: Similar Android and iOS-based devices may work as well, but have not been tested by Grundfos.

For further details, features and screens, see Grundfos GO instructions part number 98133717 that are included with GO Remote product.

Connecting pieces

The tables below show the range of connecting pieces for connection of thread-to-flange and thread-to-thread.

Thread-to- thread

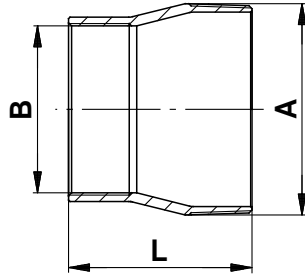

TM01 2397 1698 - GrA2555

Fig. 24 Dimensional sketch and photo of connecting piece thread-to-thread

Type	Connecting piece	Dimensions			Product number	
		Thread-to-thread		L [in. (mm)]	304 stainless steel	316 stainless steel
		A	B			
385S	NPT 5→ NPT 4	NPT 5	NPT 4	4.76 (121)	190064	190586
475S	NPT 5→ NPT 6	NPT 5	NPT 6	5.91 (150)	190070	190592
625S	NPT 6→ NPT 5	NPT 6	NPT 5	5.91 (150)	200135	200645
800S						
1100S						

Zinc anodes

Application

Cathodic protection by means of zinc can be used for corrosion protection of SP pumps in chloride-containing liquids such as brackish water and seawater.

Sacrificial anodes are placed on the outside of the pump and motor as protection against corrosion.

The number of anodes required depends on the pump and motor in question.

Please contact Grundfos for further details.

Liquid temperatures

- Seawater:
Up to 95 °F (35 °C).
- Brackish water (min. 1500 ppm (g/m³) chloride):
Up to 95 °F (35 °C).

Anode life

The zinc anodes have a life of one to four years, depending on operating conditions (temperature, flow and chloride content).

Product numbers of zinc anodes

Zinc anodes for pumps										
Product number	Used for pump type									
	SP 55 to 77S	85S	150S	230S	300S	385S	475S	625S	800S	1100S
	96421444	•	-	-	-	-	-	-	-	-
96421445	-	•	•	•	•	-	-	-	-	-
96421447	-	-	-	-	-	•	•	-	-	-
96421448	-	-	-	-	-	-	•	-	-	-
96421449	-	-	-	-	-	-	-	•	-	-
96421450	-	-	-	-	-	-	-	-	•	•

Zinc anodes for motors			
4" motors	6" motors	8" motors	10" motors
96421444	96421446	96421450	96564808

SA-SPM 6 control boxes

Application

SA-SPM 6 control boxes are used as starting units for single-phase, 3-wire motors ranging from 0.5 Hp to 5 Hp (.37 kW to 3.7 kW).

SA-SPM 6 from 1.5 Hp to 5 Hp (1.1 kW to 3.7 kW) is available in two versions, standard and deluxe.

The standard version incorporates a motor -protective circuit breaker and thus protects the motor against overload.

The deluxe version is identical to the standard version with the following addition a motor contactor is included for connection and disconnection of the power supply.

Technical data

Enclosure class: IP42.

Ambient temperature: -4 °F to +140 °F
(-20 °C to +60 °C).

Relative humidity: Maximum 95 %, normal non-aggressive atmosphere.

SA-SPM 6 control box part numbers

Version	Single phase	Volts		[Hp]					Product number	
		115 V	230 V	.5	.75	1	1.5	2		3
Standard	•	•		•						98315240 98821580
Standard	•		•	•						98315251 98821631
Standard	•		•		•					98315252 98821632
Standard	•		•			•				98315253 98821633
Standard	•		•				•			98315254
Deluxe	•		•				•			98315255
Standard	•		•					•		98315256
Deluxe	•		•					•		98315257
Standard	•		•						•	98315258
Deluxe	•		•						•	98315259
Standard	•		•						•	98315260
Deluxe	•		•						•	98315261



TM03 8150 0607

Fig. 25 SA-SPM 6 control box

Pt100

The Pt100 sensor offers these features:

- Continuous monitoring of the motor temperature
- Protection against too high motor temperature.

Protecting the motor against too high motor temperature is the simplest and cheapest way of avoiding that motor lifetime is reduced. Pt100 ensures that operating conditions are not exceeded and indicates when it is time for service of the motor.

Monitoring and protection by means of Pt100 require the following parts:

- Pt100 sensor
- Relay, type PR 5714
- Cable.

The PR 5714 relay is fitted with a Pt100 module. For both relays the following temperature limits are preset on delivery:

- 60 °C (140 °F) warning limit
- 75 °C (167 °F) stop limit.

Technical data

	Relay type
	PR 5714
Enclosure class	IP65 (mounted in a control panel)
Ambient temperature	-4 °F to +140 °F (-20 °C to +60 °C)
Relative humidity	95 % (condensating)
Voltage variation	<ul style="list-style-type: none"> • 1 x 24-230 VAC ± 10 %, 50-60 Hz. • 24-250 VDC ± 20 %.
Approvals	UL, DNV
Mark	CE

Pt100 sensor with/without PR 5714 relay and cable	Cable length [ft (m)]	PR 5714	Product number		
			MS 6000C	MMS 6 MMS 8000	MMS 10000
	65.6 (20)	Yes	96408953	96494596	96437287
	131.2 (40)	Yes	96408681	96494597	96437288
	196.9 (60)	Yes	96408954	96494598	96437289
	262.5 (80)	Yes	96408955	96494599	96437290
	328.1 (100)	Yes	96408956	96494610	96437291
	65.6 (20)	No	96658626	96658629	96658633
	131.2 (40)	No	96658627	96658630	96658634
	196.9 (60)	No	96658628	96658631	96658635
	262.5 (80)	No	96658637	96658632	96658636
	328.1 (100)	No	96658638	96658639	96658640

PR 5714 relay	Voltage	Product number
	24-230 VAC, 50/60 Hz / 24-250 VDC	96621274

Pt100 sensor including cable	Cable length [ft (m)]	Product number	
		MS 6000C MMS 6 MMS 8000	MMS 10000
	65.6 (20)	96408957	96437784
	131.2 (40)	96408684	96437785
	196.9 (60)	96408958	96437786
	262.5 (80)	96408959	96437787
	328.1 (100)	96408960	96437788

Staybolts for Pt100	Description	Product number
	Bolt KIT for Pt100 (for MS 6000C)	96611899

9. Energy consumption

Energy consumption of submersible pumps

The percentage distribution of service life costs of a submersible pump for water supply is:

- 5 % initial costs (pump)
- 85 % operating costs / energy consumption
- 10 % maintenance costs.

It is obvious that the highest savings can be achieved within energy consumption!

The annual energy consumption, E, of a submersible pump can be calculated as follows:

$$E = c \times h \times P_1 \text{ (USD)}$$

c = specific energy price (USD/kWh)

h = operating hours/year (hours)

P₁ = power input of the submersible pump (Hp).

Example: Calculation of the annual energy consumption of the submersible pump, type 625S-3. 625S-3 with MMS 8000, 60 Hp, 3 x 460 V, 60 Hz.

Duty point:

Flow rate: Q = 528 GPM

Total head: H = 335 ft

Specific energy price: c = USD 0.15/kWh (consisting of day and night rate)

Operating hours/year: h = 3200.

$$P_1 = \frac{Q \times H \times \rho}{367 \times \eta_{\text{pump}} \times \eta_{\text{motor}}} \text{ in kW}$$

Q = GPM

H = ft

Density ρ = lb/ft³ (assumed 1)

367 = conversion factor

η_{motor} = (example 84.5 %, in equation 0.845)

η_{pump} = (not to be confused with the stage efficiency curve).

By showing the P₂/Q curve we make it easier for you to calculate the energy consumption.

$$P_1 = \frac{P_2}{\eta_{\text{motor}}}$$

P₂ = 35 Hp (power requirement of 625S-3 pump at 88 GPM, from curve P₂/Q).

Calculation of motor efficiency at duty point

As standard the SP 625S-3 is equipped with a 60 Hp (45 kW for P₁) MS 6000C motor.

At duty point (Q = 528 GPM) the pump requires 59 Hp (44 kW for P₁), thus:

a motor load of 87 % (44 kw / 45 kw) and a power reserve of 2 %.

From the table on page 86 the motor efficiency can be read as:

84.6 % at a load of 75 %. (η_{75 %})

85.6 % at a load of 100 %. (η_{100 %})

The interpolated value in this example is

$$\eta_{\text{motor}} = 85.1 \%, \eta_{\text{motor}} = 0.851.$$

$$P_1 = \frac{44}{0.851} = 51.7 \text{ kW}$$

$$E = 0.15 \text{ USD/kWh} \times 3200 \text{ h} \times 51.7 \text{ kW}.$$

The annual energy costs amount to USD 24816.

The pay-off time, A, (months) is calculated as follows:

$$A = \frac{\text{Purchase price of energy - efficiency pump}}{\text{Energy savings / year}} \times 12$$

Cable sizing

In order to obtain an economical duty of the pump the voltage drop should be low.

Today large water works already size cables for a maximum voltage drop of 1 %).

The hydraulic resistance in the discharge pipe should be as low as possible.

10. Cables

Cables for Grundfos 4" submersible motors are available with or without plugs. The submersible drop cable is chosen according to application and type of installation.

Standard version: Max. liquid temperature 140 °F (60 °C).

Hot water version: Max. liquid temperature 158 °F (70 °C), for short periods up to 194 °F (90 °C) (for MS only).

Tables indicating cable dimension in borehole

The tables indicate the maximum length of drop cables in meters from motor starter to pump at direct-on-line starting at different cable dimensions.

If star/delta starting is used the current will be reduced by $\sqrt{3}$ ($I \times 0.58$), meaning that the cable length may be $\sqrt{3}$ longer ($L \times 1.73$) than indicated in the tables.

If for example the operating current is 10 % lower than the full-load current, the cable may be 10 % longer than indicated in the tables.

The calculation of the cable length is based on a maximum voltage drop of 1 % to 3 % of the rated voltage and a water temperature of maximum 86 °F (30 °C).

In order to minimize operating losses the cable cross section may be increased compared to what is indicated in the tables. This is economical only if the borehole provides the necessary space, and if the operational time of the pump is long, especially if the operating voltage is below the rated voltage.

The table values are calculated on the basis of the formula:

Max. cable length of a single-phase submersible pump:

$$L = \frac{U \times \Delta U}{I \times 2 \times 100 \times \left(\cos \varphi \times \frac{\rho}{q} + \sin \varphi \times X_L \right)} \text{ [ft]}$$

Max. cable length of a three-phase submersible pump:

$$L = \frac{U \times \Delta U}{I \times 1.73 \times 100 \times \left(\cos \varphi \times \frac{\rho}{q} + \sin \varphi \times X_L \right)} \text{ [ft]}$$

where

U = Rated voltage [V]

ΔU = Voltage drop [%]

I = Rated current of the motor [A]

q = Cross-section of submersible drop cable [in²]

X_L = Inductive resistance: 0.024×10^{-3} [Ω /ft]

$\cos \varphi$ = Power factor

$\sin \varphi = \sqrt{1 - \cos^2 \varphi}$

ρ = Specific resistance: 9.5×10^{-6} [Ω in²/ft]

Example

Motor size: 40 Hp, MMS 8000

Rated current: 64.0 A

Rated voltage: 3 x 460 V, 60 Hz

Starting method: Direct-on-line

Power factor: $\cos \varphi = 0.85$

Voltage drop: 3 %

Cross-section: 0.025 in²

$\sin \varphi$: 0.53

$$L = \frac{460 \times 3}{64.0 \times 1.73 \times 100 \times \left(0.85 \times \frac{0.0000095}{0.025} + 0.53 \times 0.024 \times 10^{-3} \right)}$$

L = 370 ft

Cable dimensions at 1 x 220 V, 60 Hz

Motor	Hp	I _n [A]	0.002 in ²	0.004 in ²	0.006 in ²	0.009 in ²	0.016 in ²
4"	0.33	3.3	315	522	833	1243	2047
	0.50	4.4	239	397	630	938	1548
	0.75	6.6	157	262	417	620	1020
	1.00	7.7	121	203	321	482	797
	1.50	9.0	98	164	259	387	643

Maximum cable length in feet from motor starter to pump.

Cable sizing charts

115 V and 230 V, 1 ph 60 Hz

Maximum submersible power cable length (max. cable length in feet - starter to motor)																	
Motor rating [Hp]	AWG copper wire size [ft (m)]													MCM copper wire size			
	14	12	10	8	6	4	3	2	1	0	00	000	0000	250	300	350	
115 V 1 ph 60 Hz	0.33	130 (40)	210 (64)	340 (104)	540 (165)	840 (256)	1300 (396)	1610 (491)	1960 (597)	2390 (728)	2910 (887)	3540 (1079)	4210 (1283)	5060 (1542)	5680 (1731)	6390 (1948)	7110 (2167)
	0.5	100 (30)	160 (49)	250 (76)	390 (119)	620 (189)	960 (293)	1190 (363)	1460 (445)	1780 (543)	2160 (658)	2630 (802)	3140 (957)	3770 (1149)	4240 (1292)	4770 (1454)	5320 (1622)
230 V 1 ph 60 Hz	0.33	550 (168)	880 (268)	1390 (424)	2190 (668)	3400 (1036)	5250 (1600)	6520 (1987)	7960 (2426)	9690 (2954)	11770 (3587)	14320 (4365)	17050 (5197)	20460 (6236)	22980 (7004)	25850 (7879)	28750 (8763)
	0.5	400 (122)	650 (198)	1020 (311)	1610 (491)	2510 (765)	3880 (1183)	4810 (1466)	5880 (1792)	7170 (2185)	8720 (2658)	10620 (3237)	12660 (3859)	15210 (4636)	17100 (5212)	19260 (5870)	21440 (6535)
	0.75	300 (91)	480 (146)	760 (232)	1200 (366)	1870 (570)	2890 (881)	3580 (1091)	4370 (1332)	5330 (1625)	6470 (1972)	7870 (2399)	9380 (2859)	11250 (3429)	12640 (3853)	14220 (4334)	15810 (4819)
	1	250 (76)	400 (122)	630 (192)	990 (302)	1540 (469)	2380 (725)	2960 (902)	3610 (1100)	4410 (1344)	5360 (1634)	6520 (1987)	7780 (2371)	9350 (2850)	10510 (3203)	11840 (3609)	13180 (4017)
	1.5	190 (58)	310 (94)	480 (146)	770 (235)	1200 (366)	1870 (570)	2320 (707)	2850 (869)	3500 (1067)	4280 (1305)	5240 (1597)	6300 (1920)	7620 (2323)	8630 (2630)	9810 (2990)	10980 (3347)
	2	150 (46)	250 (76)	390 (119)	620 (189)	970 (296)	1530 (466)	1910 (582)	2360 (719)	2930 (893)	3620 (1103)	4480 (1366)	5470 (1667)	6700 (2042)	770 (235)	8890 (2710)	10080 (3072)
	3	120 (37)	190 (58)	300 (91)	470 (143)	750 (229)	1190 (363)	1490 (454)	1850 (564)	2320 (707)	2890 (881)	3610 (1100)	4470 (1362)	5550 (1692)	6450 (1966)	7580 (2310)	8690 (2649)
	5	-	110* (34*)	180 (55)	280 (85)	450 (137)	710 (216)	890 (271)	1110 (338)	1390 (424)	1740 (530)	2170 (661)	2680 (817)	3330 (1015)	3870 (1180)	4550 (1387)	5210 (1588)
	7.5	-	-	120* (37*)	200 (61)	310 (94)	490 (149)	610 (186)	750 (229)	930 (283)	1140 (347)	1410 (430)	1720 (524)	2100 (640)	2400 (732)	2790 (850)	3120 (951)
	10	-	-	-	160* (49*)	250 (76)	390 (119)	490 (149)	600 (183)	750 (229)	930 (283)	1160 (354)	1430 (436)	1760 (536)	2030 (619)	2370 (723)	2700 (823)
15	-	-	-	-	170* (52*)	270 (82)	340 (104)	430 (131)	530 (162)	660 (201)	820 (250)	1020 (311)	1260 (384)	1460 (445)	1700 (518)	1940 (591)	

NOTE:

* Indicates single conductor only. (Not jacketed).

No * indicates both jacketed cable and single conductor cables.

1. Table based on copper wire. If aluminum wire is used, multiply lengths by 0.5.

Maximum allowable length of aluminum is considerably shorter than copper wire of same size.

2. The portion of the total cable which is between the service entrance and a motor starter/controller should not exceed 25 % of the total maximum length to assure reliable starter operation. Single-phase control boxes may be connected at any point of the total cable length.

3. Table based on a maintaining motor terminal voltage at 95 % of service entrance voltage, running at maximum nameplate amperes. In general, voltage drop should be maintained at 3 V / 100 ft or less.

4. 1 foot = .305 meter (1 meter = 3.28 feet).

200-208 V, 3 Ph 60 Hz

Maximum submersible power cable length (max. cable length in feet - starter to motor)																	
Motor rating [Hp]	AWG copper wire size [ft (m)]													MCM copper wire size			
	14	12	10	8	6	4	3	2	1	0	00	000	0000	250	300	350	
200-208 V 3 ph 60 Hz	.5	710 (216)	1140 (347)	1800 (549)	2840 (866)	4420 (1347)	-	-	-	-	-	-	-	-	-	-	-
	.75	510 (155)	810 (245)	1280 (390)	2030 (619)	3160 (963)	-	-	-	-	-	-	-	-	-	-	-
	1	430 (131)	690 (210)	1080 (329)	1710 (521)	2670 (814)	4140 (1262)	5140 (1567)	-	-	-	-	-	-	-	-	-
	1.5	310 (94)	500 (152)	790 (241)	1260 (384)	1960 (597)	3050 (930)	3780 (1152)	-	-	-	-	-	-	-	-	-
	2	240 (73)	390 (119)	610 (186)	970 (296)	1520 (463)	2360 (719)	2940 (896)	3610 (1100)	4430 (1350)	5420 (1652)	-	-	-	-	-	-
	3	180 (55)	290 (88)	470 (143)	740 (226)	1160 (354)	1810 (552)	2250 (686)	2760 (841)	3390 (1033)	4130 (1259)	-	-	-	-	-	-
	5	110* (34*)	170 (52)	280 (85)	440 (134)	690 (210)	1080 (329)	1350 (411)	1660 (506)	2040 (622)	2490 (759)	3050 (930)	3670 (1119)	4440 (1353)	5030 (1533)	-	-
	7.5	-	-	200 (61)	310 (94)	490 (149)	770 (235)	960 (293)	1180 (360)	1450 (442)	1770 (539)	2170 (661)	2600 (792)	3150 (960)	3560 (1085)	-	-
	10	-	-	-	230* (70*)	370 (113)	570 (174)	720 (219)	880 (268)	1090 (332)	1330 (405)	1640 (500)	1970 (600)	2390 (728)	2720 (829)	3100 (945)	3480 (1061)
	15	-	-	-	160* (49*)	250* (76*)	390 (119)	490 (149)	600 (183)	740 (226)	910 (277)	1110 (338)	1340 (408)	1630 (497)	1850 (564)	2100 (640)	2350 (716)
	20	-	-	-	-	190* (58*)	300* (91*)	380 (116)	460 (140)	570 (174)	700 (213)	860 (262)	1050 (320)	1270 (387)	1440 (439)	1650 (503)	1850 (564)
	25	-	-	-	-	-	240* (73*)	300* (91*)	370* (113*)	460 (140)	570 (174)	700 (213)	840 (256)	1030 (314)	1170 (357)	1330 (405)	1500 (457)
	30	-	-	-	-	-	-	250* (76*)	310* (94*)	380* (116*)	470 (143)	580 (177)	700 (213)	850 (259)	970 (296)	1110 (338)	1250 (381)

NOTE:

* Indicates single conductor only. (Not jacketed).

No * indicates both jacketed cable and single conductor cables.

- Table based on copper wire. If aluminum wire is used, multiply lengths by 0.5. Maximum allowable length of aluminum is considerably shorter than copper wire of same size.
- The portion of the total cable which is between the service entrance and a motor starter/controller should not exceed 25 % of the total maximum length to assure reliable starter operation. Single-phase control boxes may be connected at any point of the total cable length.
- Table based on a maintaining motor terminal voltage at 95 % of service entrance voltage, running at maximum nameplate amperes. In general, voltage drop should be maintained at 3 V / 100 ft or less.
- 1 foot = .305 meter (1 meter = 3.28 feet).

460 V, 3 ph 60 Hz

Maximum submersible power cable length (max. cable length in feet - starter to motor)																	
Motor rating [Hp]	AWG copper wire size [ft (m)]													MCM copper wire size			
	14	12	10	8	6	4	3	2	1	0	00	000	0000	250	300	350	
460 V 3 ph 60 Hz	.5	3770 (1149)	6020 (1835)	9460 (2883)	-	-	-	-	-	-	-	-	-	-	-	-	
	.75	2730 (832)	4350 (1326)	6850 (2088)	-	-	-	-	-	-	-	-	-	-	-	-	
	1	2300 (701)	3670 (1119)	5770 (1759)	9070 (2765)	-	-	-	-	-	-	-	-	-	-	-	
	1.5	1700 (518)	2710 (826)	4270 (1301)	6730 (2051)	-	-	-	-	-	-	-	-	-	-	-	
	2	1300 (396)	2070 (631)	3270 (997)	5150 (1570)	8050 (2454)	-	-	-	-	-	-	-	-	-	-	
	3	1000 (305)	1600 (488)	2520 (768)	3970 (1210)	6200 (1890)	-	-	-	-	-	-	-	-	-	-	
	5	590 (180)	950 (290)	1500 (457)	2360 (719)	3700 (1128)	5750 (1753)	-	-	-	-	-	-	-	-	-	
	7.5	420 (128)	680 (207)	1070 (326)	1690 (515)	2640 (805)	4100 (1250)	5100 (1554)	6260 (1908)	7680 (2341)	-	-	-	-	-	-	
	10	310 (94)	500 (152)	790 (241)	1250 (381)	1960 (597)	3050 (930)	3800 (1158)	4680 (1426)	5750 (1753)	7050 (2149)	-	-	-	-	-	
	15	-	340* (104*)	540 (165)	850 (259)	1340 (408)	2090 (637)	2600 (792)	3200 (975)	3930 (1198)	4810 (1466)	5900 (1798)	7110 (2167)	-	-	-	
	20	-	-	410 (125)	650 (198)	1030 (314)	1610 (491)	2000 (610)	2470 (753)	3040 (927)	3730 (1137)	4580 (1396)	5530 (1686)	-	-	-	
	25	-	-	330* (101*)	530 (162)	830 (253)	1300 (396)	1620 (494)	1990 (607)	2450 (747)	3010 (917)	3700 (1128)	4470 (1362)	5430 (1655)	-	-	
	30	-	-	270* (82*)	430 (131)	680 (207)	1070 (326)	1330 (405)	1640 (500)	2030 (619)	2490 (759)	3060 (933)	3700 (1128)	4500 (1372)	5130 (1564)	5860 (1786)	
	40	-	-	-	320* (98*)	500* (152*)	790 (241)	980 (299)	1210 (369)	1490 (454)	1830 (558)	2250 (686)	2710 (826)	3290 (1003)	3730 (1137)	4250 (1295)	
	50	-	-	-	-	410* (125*)	640 (195)	800 (244)	980 (299)	1210 (369)	1480 (451)	1810 (552)	2190 (668)	2650 (808)	3010 (917)	3420 (1042)	3830 (1167)
	60	-	-	-	-	-	540* (165*)	670* (204*)	830 (253)	1020 (311)	1250 (381)	1540 (469)	1850 (564)	2240 (683)	2540 (774)	2890 (881)	3240 (988)
	75	-	-	-	-	-	440* (134*)	550* (168*)	680* (207*)	840 (256)	1030 (314)	1260 (384)	1520 (463)	1850 (564)	2100 (640)	2400 (732)	2700 (823)
	100	-	-	-	-	-	-	-	500* (152*)	620 (189*)	760* (232*)	940 (287)	1130 (344)	1380 (421)	1560 (475)	1790 (546)	2010 (613)
	125	-	-	-	-	-	-	-	-	-	600* (183*)	740* (226*)	890* (271*)	1000 (305)	1220 (372)	1390 (424)	1560 (475)
	150	-	-	-	-	-	-	-	-	-	-	630* (192*)	760* (232*)	920* (280*)	1050 (320)	1190 (363)	1340 (408)
175	-	-	-	-	-	-	-	-	-	-	-	670* (204*)	810* (247*)	930* (283*)	1060 (323)	1190 (363)	
200	-	-	-	-	-	-	-	-	-	-	-	590* (180*)	710* (216*)	810* (247*)	920* (280*)	1030 (314)	

NOTE:

* Indicates single conductor only. (Not jacketed).

No * indicates both jacketed cable and single conductor cables.

1. Table based on copper wire. If aluminum wire is used, multiply lengths by 0.5.

Maximum allowable length of aluminum is considerably shorter than copper wire of same size.

2. The portion of the total cable which is between the service entrance and a motor starter/controller should not exceed 25 % of the total maximum length to assure reliable starter operation. Single-phase control boxes may be connected at any point of the total cable length.

3. Table based on a maintaining motor terminal voltage at 95 % of service entrance voltage, running at maximum nameplate amperes. In general, voltage drop should be maintained at 3 V / 100 ft or less.

4. 1 foot = .305 meter (1 meter = 3.28 feet).

575 V, 3 ph 60 Hz

Maximum submersible power cable length (max. cable length in feet - starter to motor)																	
Motor rating [Hp]	AWG copper wire size [ft (m)]													MCM copper wire size			
	14	12	10	8	6	4	3	2	1	0	00	000	0000	250	300	350	
575 V 3 ph 60 Hz	5	5900 (1798)	9410 (2868)	-	-	-	-	-	-	-	-	-	-	-	-	-	
	.75	4270 (1301)	6810 (2076)	-	-	-	-	-	-	-	-	-	-	-	-	-	
	1	3630 (1106)	5800 (1768)	9120 (2780)	-	-	-	-	-	-	-	-	-	-	-	-	
	1.5	2620 (799)	4180 (1274)	6580 (2006)	-	-	-	-	-	-	-	-	-	-	-	-	
	2	2030 (619)	3250 (991)	5110 (1558)	8060 (2457)	-	-	-	-	-	-	-	-	-	-	-	
	3	1580 (482)	2530 (771)	3980 (1213)	6270 (1911)	-	-	-	-	-	-	-	-	-	-	-	
	5	920 (280)	1480 (451)	2330 (710)	3680 (1122)	5750 (1753)	-	-	-	-	-	-	-	-	-	-	
	7.5	660 (201)	1060 (323)	1680 (512)	2650 (808)	4150 (1265)	-	-	-	-	-	-	-	-	-	-	
	10	490 (149)	780 (238)	1240 (378)	1950 (594)	3060 (933)	4770 (1454)	5940 (1811)	-	-	-	-	-	-	-	-	
	15	330* (101*)	530 (162)	850 (259)	1340 (408)	2090 (637)	3260 (994)	4060 (1237)	-	-	-	-	-	-	-	-	
	20	-	410* (125*)	650 (198)	1030 (314)	1610 (491)	2520 (768)	3140 (957)	3860 (1177)	4760 (1451)	5830 (1777)	-	-	-	-	-	
	25	-	-	520 (158)	830 (253)	1300 (396)	2030 (619)	2530 (771)	3110 (948)	3840 (1170)	4710 (1436)	-	-	-	-	-	
	30	-	-	430* (131*)	680 (207)	1070 (326)	1670 (509)	2080 (634)	2560 (780)	3160 (963)	3880 (1183)	4770 (1454)	5780 (1762)	7030 (2143)	8000 (2438)	-	-
	40	-	-	-	500* (152*)	790 (241)	1240 (378)	1540 (469)	1900 (579)	2330 (710)	2860 (872)	3510 (1070)	4230 (1289)	5140 (1567)	5830 (1777)	-	-
	50	-	-	-	410* (125*)	640* (195*)	1000 (305)	1250 (381)	1540 (469)	1890 (576)	2310 (704)	2840 (866)	3420 (1042)	4140 (1262)	4700 (1433)	5340 (1628)	5990 (1826)
	60	-	-	-	-	540* (165*)	850 (259)	1060 (323)	1300 (396)	1600 (488)	1960 (597)	2400 (732)	2890 (881)	3500 (1067)	3970 (1210)	4520 (1378)	5070 (1545)
	75	-	-	-	-	-	690* (210*)	860 (262)	1060 (323)	1310 (399)	1600 (488)	1970 (600)	2380 (725)	2890 (881)	3290 (1003)	3750 (1143)	4220 (1286)
	100	-	-	-	-	-	-	640* (195*)	790* (241*)	970 (296)	1190 (363)	1460 (445)	1770 (539)	2150 (655)	2440 (744)	2790 (850)	3140 (957)
	125	-	-	-	-	-	-	-	630* (192*)	770* (235*)	950 (290)	1160 (354)	1400 (427)	1690 (515)	1920 (585)	2180 (664)	2440 (744)
	150	-	-	-	-	-	-	-	-	660* (202*)	800* (244*)	990* (302*)	1190 (363)	1440 (439)	1630 (497)	1860 (567)	2080 (634)
175	-	-	-	-	-	-	-	-	-	700* (214*)	870* (265*)	1050* (320*)	1270 (387)	1450 (442)	1650 (503)	1860 (567)	
200	-	-	-	-	-	-	-	-	-	-	760* (232*)	920* (280*)	1110* (338*)	1260 (384)	1440 (439)	1620 (494)	

NOTE:

* Indicates single conductor only. (Not jacketed).

No * indicates both jacketed cable and single conductor cables.

1. Table based on copper wire. If aluminum wire is used, multiply lengths by 0.5.

Maximum allowable length of aluminum is considerably shorter than copper wire of same size.

2. The portion of the total cable which is between the service entrance and a motor starter/controller should not exceed 25 % of the total maximum length to assure reliable starter operation. Single-phase control boxes may be connected at any point of the total cable length.

3. Table based on a maintaining motor terminal voltage at 95 % of service entrance voltage, running at maximum nameplate amperes. In general, voltage drop should be maintained at 3 V / 100 ft or less.

4. 1 foot = .305 meter (1 meter = 3.28 feet).

11. Friction loss tables

		Friction loss table - SCH 40 steel pipe								
[US gpm]	[US gph]	.5"	.75"	1"	1.25"	1.5"	2"	2.5"	3"	4"
		ID 0.622"	ID 0.824"	ID 1.049"	ID 1.380"	ID 1.610"	ID 2.067"	ID 2.469"	ID 3.068"	ID 4.026"
		Friction loss in feet of head per 100 feet of pipe								
2	120	4.8								
3	180	10.0	2.5							
4	240	17.1	4.2							
5	300	25.8	6.3	1.9						
6	360	36.5	8.9	2.7						
7	420	48.7	11.8	3.6						
8	480	62.7	15.0	4.5						
9	540	78.3	18.8	5.7						
10	600	95.9	23.0	6.9						
12	720		32.6	9.6	2.5	1.2				
14	840		43.5	12.8	3.3	1.5				
16	960		56.3	16.5	4.2	2.0				
20	1,200		86.1	25.1	6.3	2.9				
25	1,500			38.7	9.6	4.5	1.3			
30	1,800			54.6	13.6	6.3	1.8			
35	2,100			73.3	18.2	8.4	2.4			
40	2,400			95.0	23.5	10.8	3.1	1.3		
45	2,700				29.4	13.5	3.9	1.6		
50	3,000				36.0	16.4	4.7	1.9		
60	3,600				51.0	23.2	6.6	2.7		
70	4,200				68.8	31.3	8.9	3.6	1.2	
80	4,800				89.2	40.5	11.4	4.6	1.6	
90	5,400					51.0	14.2	5.8	2.0	
100	6,000					62.2	17.4	7.1	2.4	
120	7,200						24.7	10.1	3.4	
140	8,400						33.2	13.5	4.5	1.2
160	9,600						43.0	17.5	5.8	1.5
200	12,000						66.3	27.0	8.9	2.3
260	15,600							45.0	14.8	3.7
300	18,000							59.6	19.5	4.9

Friction loss table - SCH 40 PVC pipe										
[US gpm]	[US gph]	.5"	.75"	1"	1.25"	1.5"	2"	2.5"	3"	4"
		ID 0.622"	ID 0.824"	ID 1.049"	ID 1.380"	ID 1.610"	ID 2.067"	ID 2.469"	ID 3.068"	ID 4.026"
Friction loss in feet of head per 100 feet of pipe										
2	120	4.1								
3	180	8.7	2.2							
4	240	14.8	3.7							
5	300	22.2	5.7	1.8						
6	360	31.2	8.0	2.5						
7	420	41.5	10.6	3.3						
8	480	53.0	13.5	4.2						
9	540	66.0	16.8	5.2						
10	600	80.5	20.4	6.3	1.7					
12	720		28.6	8.9	2.3	1.1				
14	840		38.0	11.8	3.1	1.4				
16	960		48.6	15.1	4.0	1.9				
20	1,200		60.5	22.8	6.0	2.8				
25	1,500			38.7	9.1	4.3	1.3			
30	1,800				12.7	6.0	1.8			
35	2,100				16.9	8.0	2.4			
40	2,400				21.6	10.2	3.0	1.1		
45	2,700				28.0	12.5	3.8	1.4		
50	3,000					15.4	4.6	1.7		
60	3,600					21.6	6.4	2.3		
70	4,200					28.7	8.5	3.0	1.2	
80	4,800					36.8	10.9	3.8	1.4	
90	5,400					45.7	13.6	4.8	1.8	
100	6,000					56.6	16.5	5.7	2.2	
120	7,200						23.1	8.0	3.0	
140	8,400						30.6	10.5	4.0	1.1
160	9,600						39.3	13.4	5.0	1.4
200	12,000						66.3	20.1	7.6	2.1
260	15,600							32.4	12.2	3.4
300	18,000							42.1	15.8	4.4

Type of fitting and application	Pipe and fitting	Nominal size of fitting and pipe						
		1/2"	3/4"	1"	1.25"	1.5"	2"	2.5"
Friction loss in equivalent length of straight pipe in feet								
Insert coupling	Plastic	3	3	3	3	3	3	3
Threaded adapter (plastic to thread)	Plastic	3	3	3	3	3	3	3
90 ° standard elbow	Steel	2	2	3	4	4	5	6
	Plastic	2	2	3	4	4	5	6
Standard tee (flow through run)	Steel	1	2	2	3	3	4	4
	Plastic	1	2	2	3	3	4	4
Standard tee (flow through side)	Steel	4	5	6	7	8	11	13
	Plastic	4	5	6	7	8	11	13
Gate valve ¹	Steel	1	1	1	1	2	2	2
Swing check valve ¹	Steel	5	7	9	12	13	17	21

Notes:
 Based on Schedule 40 steel and plastic fittings.
 Friction loss figures are for screwed valves and are based on equivalent lengths of steel pipe.

12. Further product documentation

Grundfos Product Center is an online search and sizing tool to help you make the right choice.

<http://product-selection.grundfos.com>



SIZING enables you to size a pump based on entered data and selection choices.

REPLACEMENT enables you to find a replacement product. Search results will include information on

- the lowest purchase price
- the lowest energy consumption
- the lowest total life cycle cost.

www.grundfos.us Login

GRUNDFOS | PRODUCT CENTER Product range: USA | 60 Hz | Language: English (USA)
Change settings

HOME FIND PRODUCT COMPARE YOUR PROJECTS SAVED ITEMS HELP 1.5.29

FIND PRODUCTS AND SOLUTIONS

Input product number or a whole or partial product name SEARCH

SIZING
Enter pump sizing

CATALOG
Product and services

REPLACEMENT
Replace an old pump with a new

LIQUIDS
Find liquid pump

QUICK SIZING

Enter duty point:

Flow (Q)* US gpm

Head (H)* ft

Select what to size by:

Size by application

Size by pump design

Size by pump family

START SIZING

ADVANCED SIZING: Advanced sizing by application Guided selection

CATALOG gives you access to the Grundfos product catalog.

LIQUIDS enables you to find pumps designed for aggressive, flammable or other special liquids.

All the information you need in one place

Performance curves, technical specifications, pictures, dimensional drawings, motor curves, wiring diagrams, spare parts, service kits, 3D drawings, documents, system parts. The Product Center displays any recent and saved items - including complete projects - right on the main page.

Downloads

On the product pages, you can download installation and Operating Instructions, data booklets, service instructions, etc. in PDF format.

Grundfos GO

Mobile solution for professionals on the GO!

Grundfos GO is the mobile tool box for professional users on the go. It is the most comprehensive platform for mobile pump control and pump selection including sizing, replacement and documentation. It offers intuitive, handheld assistance and access to Grundfos online tools, and it saves valuable time for reporting and data collection.



GET IT ON
Google play

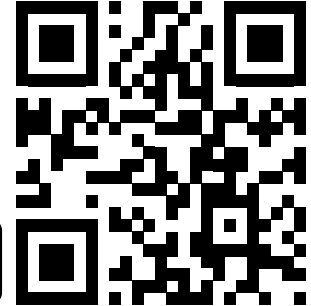

Available on the
App Store

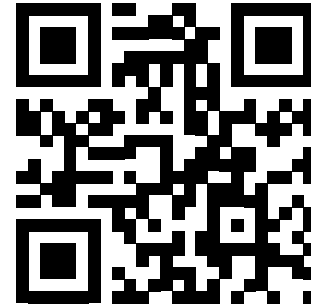

Subject to alterations.

98992402 1015

ECM: 1168473

Grundfos Kansas City

17100 West 118th Terrace
Olathe, Kansas 66061
Phone: 913-227-3400
Fax: 913-227-3500
www.grundfos.us

Grundfos Canada

2941 Brighton Road
Oakville, Ontario L6H 6C9 Canada
Phone: +1-905-829-9533
Fax: +1-905-829-9512
www.grundfos.ca

Grundfos México

Boulevard TLC No. 15
Parque Industrial Stiva Aeropuerto
C.P. 66600 Apodaca, N.L. Mexico
Phone: 011-52-81-8144 4000
Fax: 011-52-81-8144 4010
www.grundfos.mx