

700 SERIES

703 LE51A A2W (B10)

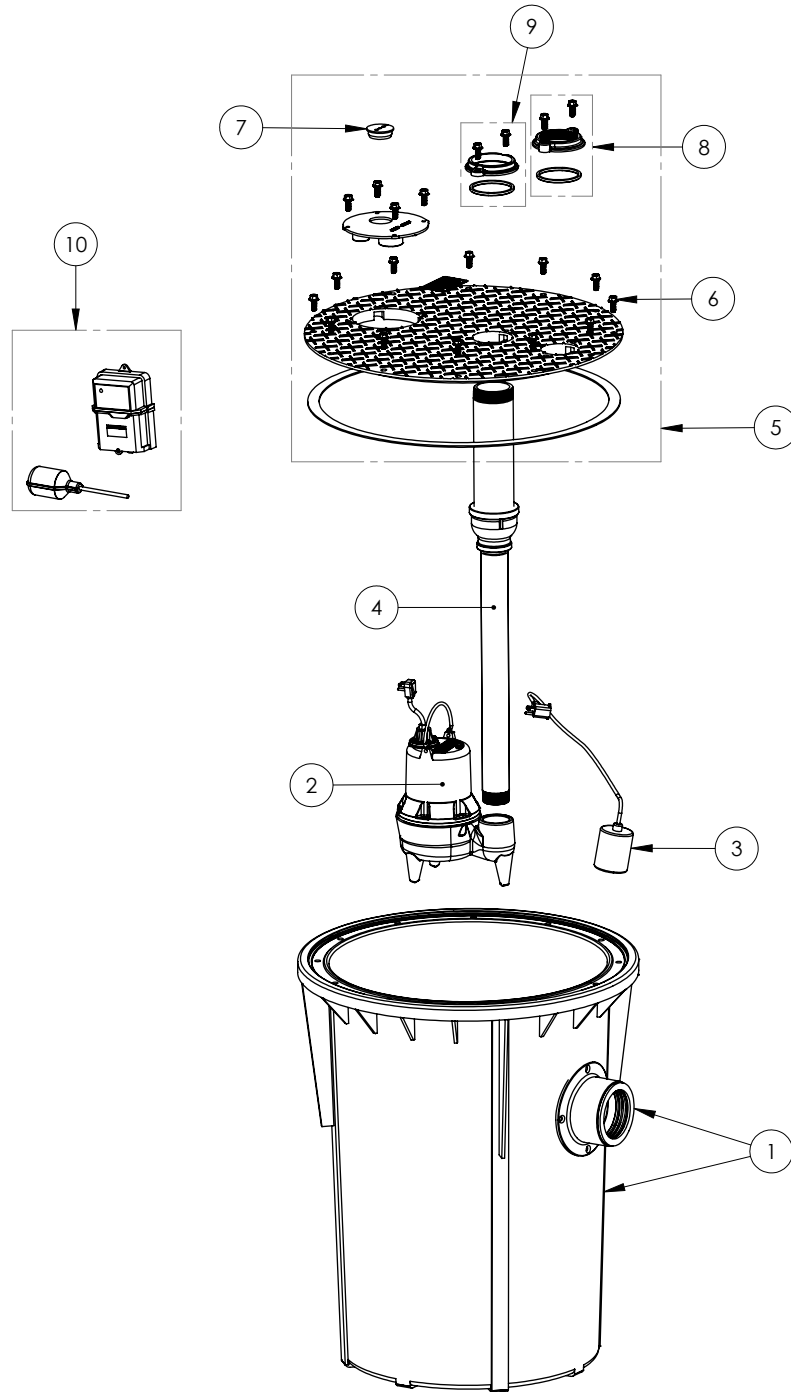

700 SERIES**703 LE51A A2W (B10)**

#	PART #	DESCRIPTION	QTY	Note
1	K001199	700 SERIES TANK AND CAST IRON HUB KIT	1	
2	LE51A	1/2 HP 2" SOLIDS HANDLING SEWAGE PUMP	1	
3	K001001	PUMP SWITCH KIT, INCLUDES MOUNTING HARDWARE	1	
4	4068000	NIPPLE 2x36 PVC SCH 80	1	
5	K001449	KIT COVER ASSEMBLY	1	
6	1176000	SCREW FLANGE HEAD 3/8"-16	20	
7	45480D0	2" THREE HOLE STOPPER	1	
8	K001392	3" VENT FLANGE KIT	1	
9	K001391	3" DISCHARGE FLANGE KIT	1	
10	ALM-2W	115V ALARM, WEATHERPROOF	1	

703_LE51A_A2W (B10)

703_LE51A_A2W (B10)

PAGE