

PRODUCT INFORMATION PACKET

marathon[®]
Motors

Model No: 256TTFCD6030
Catalog No: GT1125A
20,1800,TEFC,256T,3/60/575
Totally Enclosed Fan Cooled (TEFC)



Regal and Marathon are trademarks of Regal Beloit Corporation or one of its affiliated companies.
©2018 Regal Beloit Corporation, All Rights Reserved. MC017097E

REGAL[®]

Nameplate Specifications

Output HP	20 Hp	Output KW	14.9 kW
Frequency	60 Hz	Voltage	575 V
Current	19.4 A	Speed	1768 rpm
Service Factor	1.15	Phase	3
Efficiency	93 %	Duty	Continuous
Insulation Class	F	Design Code	B
KVA Code	G	Frame	256T
Enclosure	Totally Enclosed Fan Cooled	Overload Protector	No
Ambient Temperature	40 °C	Drive End Bearing Size	6309
Opp Drive End Bearing Size	6209	UL	Listed
CSA	Y	CE	Y
IP Code	55		

Technical Specifications

Electrical Type	Squirrel Cage Inverter Rated	Starting Method	Line Or Inverter
Poles	4	Rotation	Reversible
Mounting	Rigid Base	Motor Orientation	Horizontal
Drive End Bearing	Ball	Opp Drive End Bearing	Ball
Frame Material	Cast Iron	Shaft Type	T
Overall Length	25.89 in	Frame Length	9.84 in
Shaft Diameter	1.626 in	Shaft Extension	4 in
Assembly/Box Mounting	F1/F2 Capable		
Outline Drawing	SS620703	Connection Diagram	EE7300

This is an uncontrolled document once printed or downloaded and is subject to change without notice. Date Created: 10/08/2018

4

3

2

1

OUTLINE

B

B

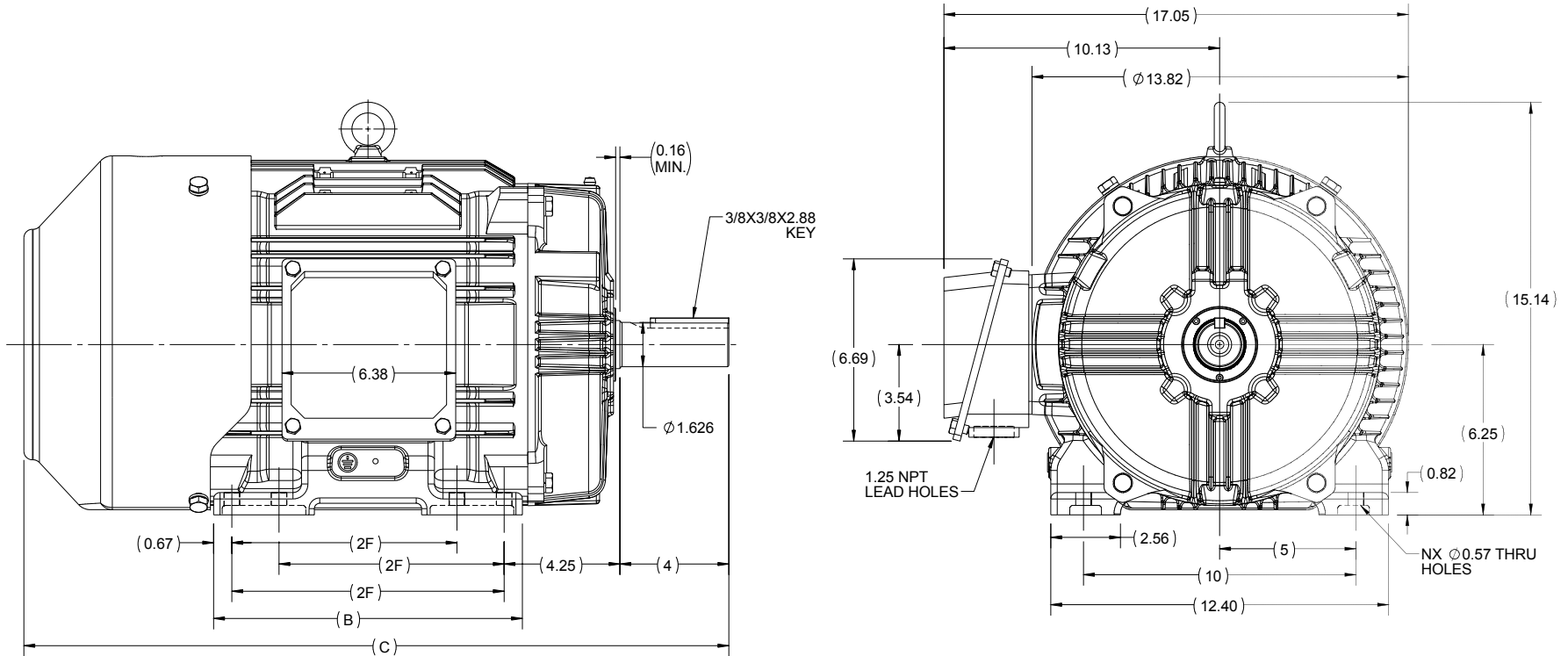

A

A

256T	11.34	25.89	10	8
254T	9.60	24.15	8.25	4
FRAME	B	C	2F	N

DRAWING REVISION A	REVISION BY UDAY	DATE 08/09/2015
ECO SBD	APPROVED BY SBD	DATE 08/09/2015
ECO DESCRIPTION NEW DRAWING RELEASE		
<small>COPYRIGHT REGAL BELOIT AMERICA, INC. ALL RIGHTS RESERVED. PROPRIETARY AND CONFIDENTIAL INFORMATION - THIS DOCUMENT IS THE PROPERTY OF REGAL BELOIT AMERICA, INC. ("OWNER") AND CONTAINS OWNER'S PROPRIETARY INFORMATION. ANY PERSON, CORPORATION OR OTHER FIRM RECEIVING IT IS DEEMED, BY RECEIVING IT, TO AGREE THAT IT, AND/OR ANY PART OF IT, SHALL NOT BE DISCLOSED TO ANY PERSON, CORPORATION OR OTHER ENTITY, DUPLICATED, AND/OR USED, EXCEPT AS EXPRESSLY APPROVED IN WRITING IN ADVANCE BY OWNER. THIS DOCUMENT SHALL BE RETURNED TO OWNER UPON REQUEST. IT MAY BE SUBJECT TO CERTAIN RESTRICTIONS UNDER APPLICABLE EXPORT CONTROL LAWS AND REGULATIONS.</small>		

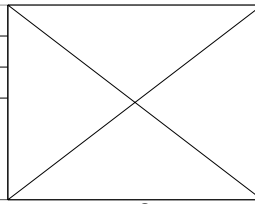

DRAWN BY MR
DATE 4/5/2015
APPROVED BY KRK
DATE 4/5/2015
REFERENCE
THIRD ANGLE PROJECTION

 REGAL-BELOIT CORPORATION	
DESCRIPTION OUTLINE 254/256T FR-TEFC-CAST IRON	
MATERIAL	PROCESS/FINISH
SIZE B	DRAWING NUMBER SS620703
	SHEET 1 OF 1

**THREE PHASE - SINGLE VOLTAGE
MOTOR - CONDUIT BOX @ 'A'**

**TO REVERSE ROTATION:
INTERCHANGE ANY TWO
LINE LEAD CONNECTIONS.**

TERMINAL BLOCK WHEN SPECIFIED



VIEW OF TERMINAL END

**IF MOTOR HAS
6 LEADS**





A-9806 DECAL

**OPTIONAL CORD
CONNECTION**

- L1 WHITE
- L2 RED
- L3 BLACK

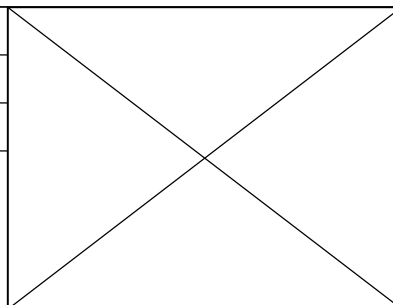
DRAWING REVISION AB	REVISION BY JJB	DATE 06-27-2017
ECO ECO-0125361	APPROVED BY TB	DATE 06-27-2017
ECO DESCRIPTION UPDATED TO CURRENT STANDARDS		
<small>COPYRIGHT REGAL BELOIT AMERICA, INC. ALL RIGHTS RESERVED. PROPRIETARY AND CONFIDENTIAL INFORMATION - THIS DOCUMENT IS THE PROPERTY OF REGAL BELOIT AMERICA, INC. ("OWNER") AND CONTAINS OWNER'S PROPRIETARY INFORMATION. ANY PERSON, CORPORATION OR OTHER FIRM RECEIVING IT IS DEEMED, BY RECEIVING IT, TO AGREE THAT IT, AND/OR ANY PART OF IT, SHALL NOT BE DISCLOSED TO ANY PERSON, CORPORATION OR OTHER ENTITY, DUPLICATED, AND/OR USED, EXCEPT AS EXPRESSLY APPROVED IN WRITING IN ADVANCE BY OWNER. THIS DOCUMENT SHALL BE RETURNED TO OWNER UPON REQUEST. IT MAY BE SUBJECT TO CERTAIN RESTRICTIONS UNDER APPLICABLE EXPORT CONTROL LAWS AND REGULATIONS.</small>		



DRAWN BY DA	 Regal Beloit America, Inc.
DATE 03-26-1993	
APPROVED BY TB	DESCRIPTION CONNECTION DIAGRAM
DATE 03-26-1993	EXTERNAL - SINGLE VOLTAGE - 3Ø MOTOR
REFERENCE	MATERIAL
PROCESS/FINISH	
THIRD ANGLE PROJECTION 	SIZE A
DRAWING NUMBER EE7300	SHEET 1 OF 1



**P.O. BOX 8003
WAUSAU, WI 54401-8003
PH. 715-675-3311**

CERTIFICATION DATA SHEET

CUSTOMER PO #:
MODEL #: 256TTFCDD6030 AA
CUSTOMER PART #:
MOUNTING: F1/F2 CAPABLE

OUTLINE: SS620703
WINDING #: HE31604010 3

TYPICAL MOTOR PERFORMANCE DATA

HP	KW	SYNC. RPM	F.L. RPM	FRAME	ENCLOSURE	KVA CODE	DESIGN	
20	14.9	1800	1768	256T	TEFC	G	B	
PH	HZ	VOLTS	AMPS	START TYPE	DUTY	INSL	S.F.	AMB°C
3	60	575	19.4	LINE OR INVERTER	CONTINUOUS	F7	1.15	40

FULL LOAD EFF:	93	3/4 LOAD EFF:	93	1/2 LOAD EFF:	91.7	GTD. EFF	ELEC. TYPE
FULL LOAD PF:	83.5	3/4 LOAD PF:	79	1/2 LOAD PF:	69	92.4	SQ CAGE INV RATED
F.L. TORQUE LB-FT	LOCKED ROTOR AMPS	L.R. TORQUE LB-FT	200 %	B.D. TORQUE LB-FT	246 %	F.L. RISE°C	
59.4	115.2	119	146	146	246	60	

SOUND PRESSURE @ 3 FT. DBA	SOUND POWER DBA	ROTOR WK^2 LB-FT^2	MAX. WK^2 LB-FT^2	SAFE STALL TIME SEC.	STARTS / HOUR	APPROX. MOTOR WGT LBS.
65	75	3.8	125	20	2	455

***** SUPPLEMENTAL INFORMATION *****

DE BRACKET TYPE	ODE BRACKET TYPE	MOUNT TYPE	ORIENTATION	SEVERE DUTY	HAZARDOUS LOCATION	DRIP COVER	SCREENS	PAINT
STANDARD	STANDARD	RIGID	HORIZONTAL	FALSE	DIVISION 2 T2B	FALSE	NONE	BLUE (ENAMEL)
BEARINGS DE	ODE	GREASE	SHAFT TYPE	SPECIAL DE	SPECIAL ODE	SHAFT MATERIAL	FRAME MATERIAL	
BALL	BALL	POLYREX EM	T	NONE	NONE	1045 HOT ROLLED (C-204)	CAST IRON	
6309	6209							

THERMO-PROTECTORS				THERMISTORS			CONTROL		SPACE HEATERS	
THERMOSTATS	PROTECTORS	WDG RTDS	BRG RTDS	NONE	FALSE	NONE	FALSE	NONE	NONE	VOLTS
NONE	NOT	NONE	NONE							

* INVERTER	
TORQUE:	CONSTANT 20:1/VARIABLE 20:1
INV. HP SPEED RANGE:	NONE
ENCODER: NONE	
O	NONE
T	NONE
E	PPR
BRAKE: NONE	
S	NONE
P/N NONE	
NONE	
NONE	
FT-LB NONE	
V NONE	
HZ	

PREPARED BY: Fareeda Dudekula
DATE: 05/04/2018 08:29:06 AM
FORM 3531 REV.3 02/07/99
**** Subject to change without notice.**

MARATHON ELECTRIC CORPORATION

TYPICAL PERFORMANCE CURVE for AC MOTOR

Customer

Curve at

575

Volts

HP 20.00

PHASE 3

Model No 256TTFCD6030

60

HZ

VOLTS 575

20

HP

Catalog No GT1125A

HZ 60

RPM 1768

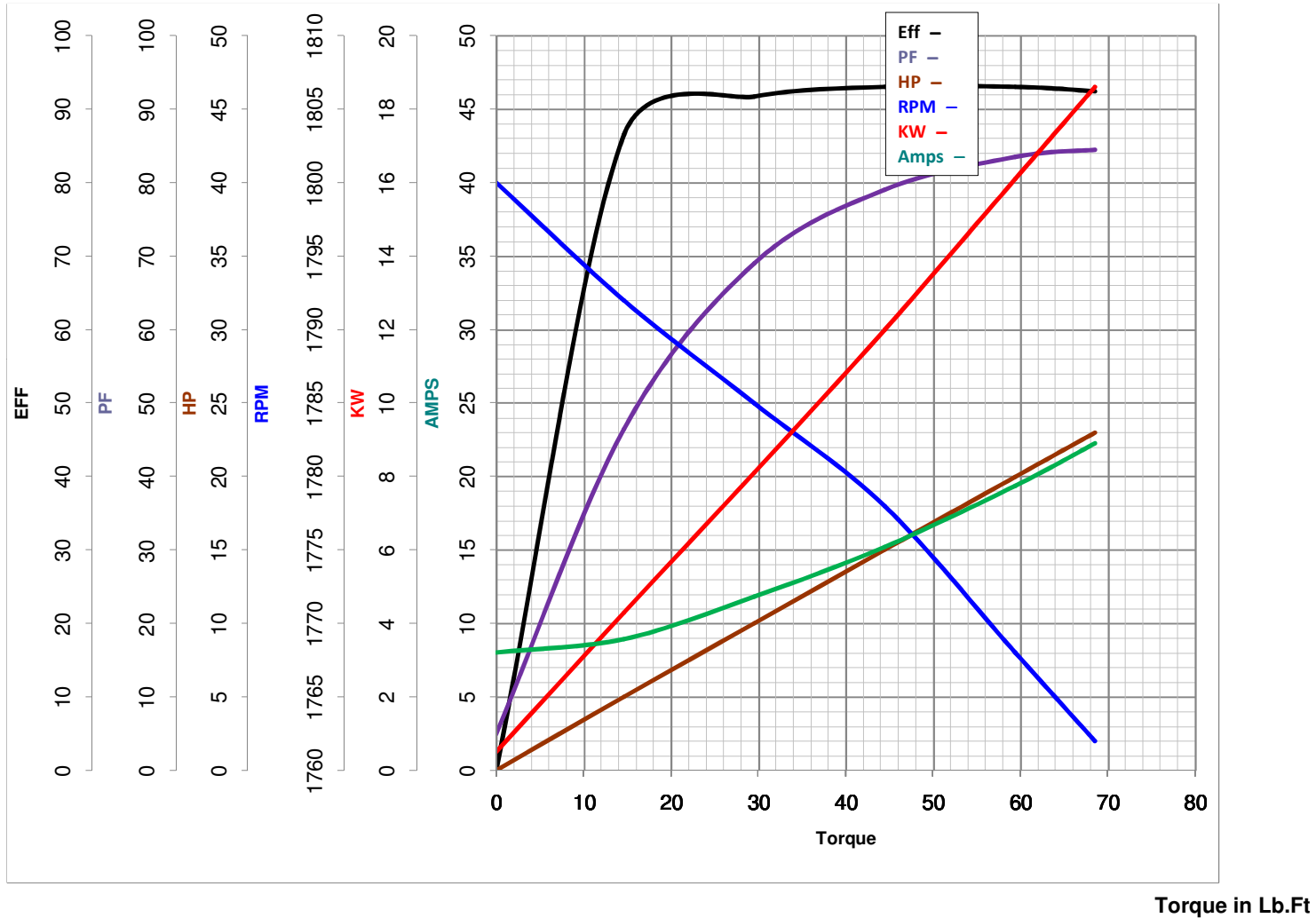

FL TORQUE 59.4 Lb.Ft
 BD TORQUE 146.0 Lb.Ft
 LR TORQUE 119 Lb.Ft

FL AMPS 19.4
 PU TORQUE 99.0 Lb.Ft
 LR AMPS 115.2

WINDING HE31604010-3 Prepared By FAREEDA

Date 5/4/2018