

PC257-442-10A (B93)

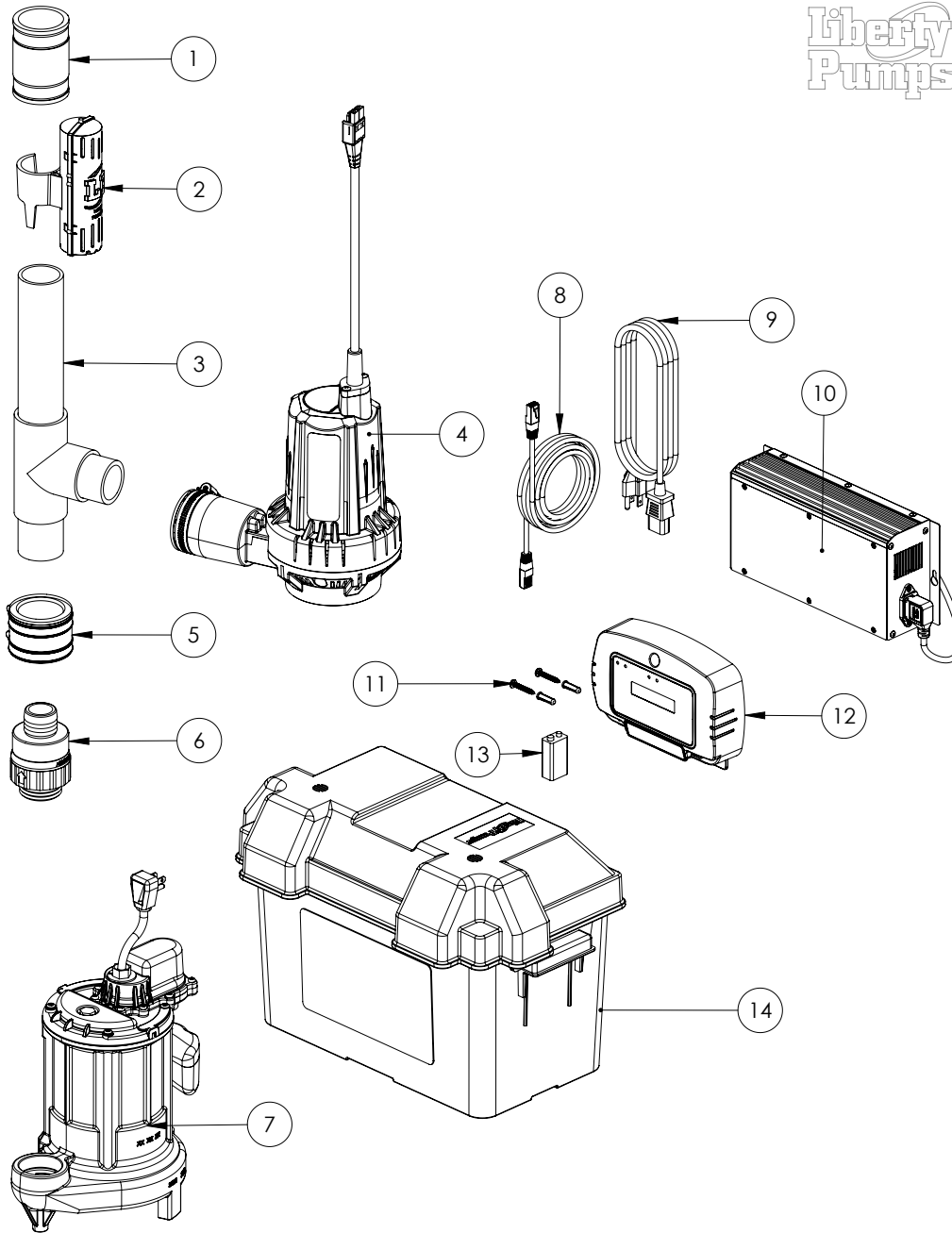

PC257-442-10A (B93)

#	PART #	DESCRIPTION	QTY	Note
1	4424000	1-1/2" X 1-1/2" RUBBER COUPLING	1	
2	K001577	DUAL REED SWITCH ASSEMBLY KIT	1	
3	1099000	GLUED TEE ASSEMBLY	1	
4	442	12VDC BATTERY BACKUP PUMP STORM CELL	1	
5	6706200	PVC FLEXIBLE COUPLING ASSY	1	
6	CV150-125T	CHECK VALVE 1.5" THREAD, 1.25" BARB	1	
7	257	LIBERTY PUMPS 1/3HP, 115V VMF SUMP PUMP	1	
8	K001578	8FT ETHERNET CABLE	1	
9	K001579	CHARGER POWER CORD	1	
10	K001580	10A CHARGER AND PWR CORD KIT	1	
11	2119000	FASTENER-ALM SERIES MOUNTING	2	
12	K001616	INTERFACE, 442 CHARGER	1	
13	K001567	KIT, BATTERY 9V, 625MAH	1	
14	K001574	STORM CELL SINGLE BATTERY BOX	1	