

P382LE51SD-2 (B10)

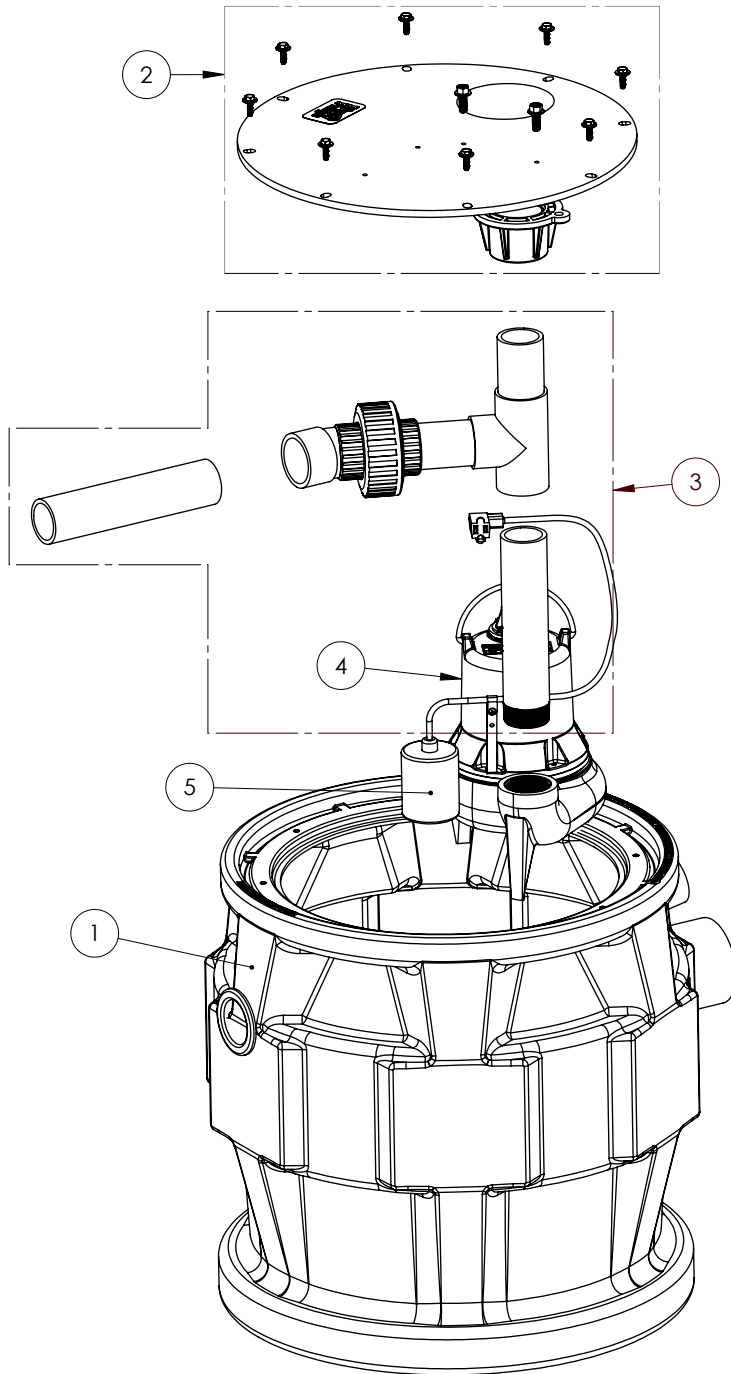

P382LE51SD-2

P382LE51SD-2 (B10)

#	PART #	DESCRIPTION	QTY	Note
1	K001536	TANK KIT SIDE DISCHARGE P380	1	
2	K001533	COVER KIT, SIDE DISCHARGE P380	1	
3	K001534	GLUED PIPING KIT, SIDE DISCHARGE P380	1	
4	LE51M-2	1/2 HP SEWAGE PUMP 115V, 25' POWER CORD	1	
5	61130B0	25' SW. FLOAT 115V N/O	1	