

P372LE51 (B94)

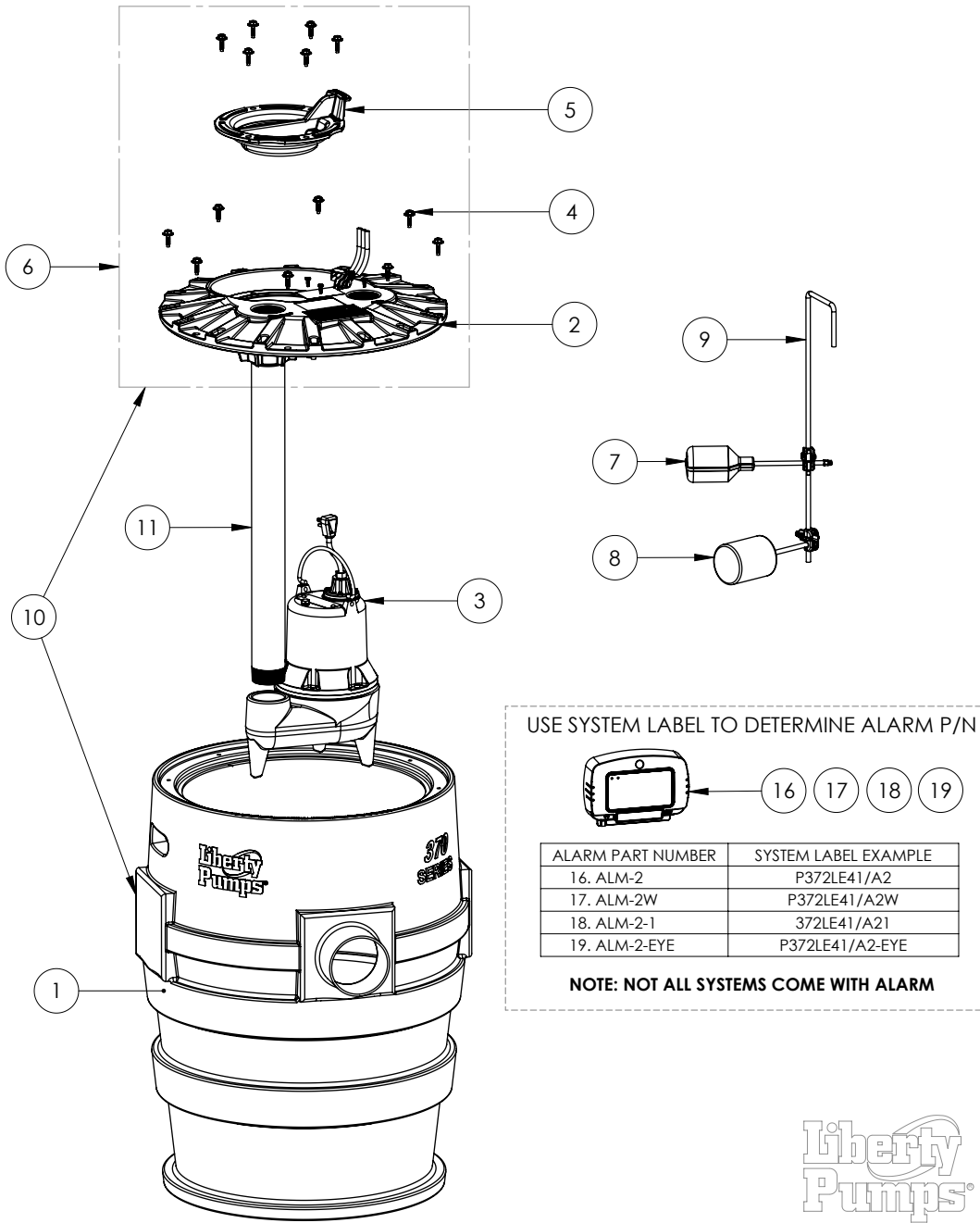

P372LE51

P372LE51 (B94)

#	PART #	DESCRIPTION	QTY	Note
1	K001132	41 GALLON TANK	1	
2	50340A0	2X2 COVER, 8 BOLTS, FOR PVC PIPE	1	
3	LE51M	1/2 HP SEWAGE PUMP 115V, 10' POWER CORD	1	
4	K001162	COVER HARDWARE, WASHER HEAD HEX SCREWS 14 INCLUDED IN KIT	1	
5	K001233	INSPECTION COVER, INCLUDES MOUNTING SCREWS (6)	1	
6	K001101	COVER ASY 2X2, 8 BOLTS, FOR PVC PIPE	1	
7	Pro Series Alarm switch (B94)	REPLACEMENT SWITCH BASED ON SYSTEM LABEL	1	[1]
8	K001054	61130A0 PUMP SWITCH, 10' 115V	1	
9	K001123	QUICKTREE KIT, ROD & CLAMPS ONLY	1	
10	K001108	P372 TANK & 2X2 COVER ASSEMBLY	1	
11	40650A0	2" PVC PIPE FOR 30" TANK, 23-5/8" LONG	1	
16	ALM-2	ALARM 115V SWT-ACTV 20'	1	
17	ALM-2W	115V ALARM, WEATHERPROOF	1	
18	ALM-2-1	ALARM 115V 10FT CORD	1	
19	ALM-2-EYE	ALARM 115V SWT-ACTV 20' NIGHTEYE	1	
20	K001134	FLOAT SWITCH, 20FT CORD, INCLUDES 1 SWITCH PER KIT	1	
21	K001566	KIT, SWITCH PILOT DUTY, 10' 3-PIN	1	
22	K001569	KIT, SWITCH PILOT DUTY, 20' 3-PIN	1	

PART NOTES:

[1] - **NOTE**

ALARM SWITCH KITS

For /A2 Suffix of model number use Part No. K001569

For /A21 Suffix of model number use Part No. K001566

For /A2W Suffix of model number use Part No. K001134

For /A2-EYE Suffix of model number use Part No. K001569