

P372LE51

P372LE51 (B10)

NOTE: NOT ALL SYSTEMS COME WITH ALARM

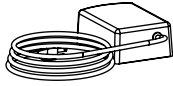

ALARM OPTIONS	ADD SUFFIX	LABEL EXAMPLE	PART NUMBER
ALM-2	/A2	P382LE41/A2	6224000
ALM-2W	/A2W	P382LE41/A2W	6626000
ALM-2-1	/A21	382LE41/A21	6222000

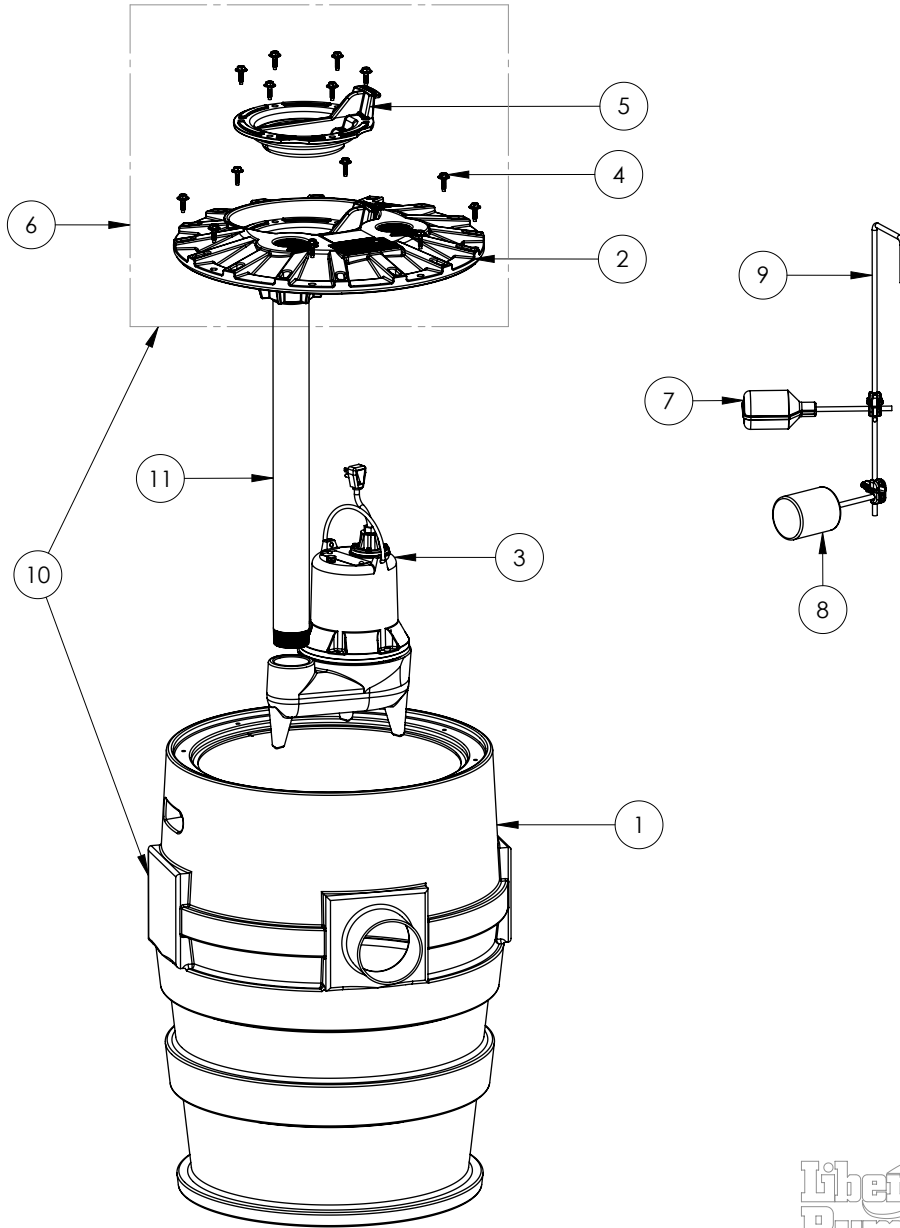

P372LE51

P372LE51 (B10)

#	PART #	DESCRIPTION	QTY	Note
1	K001132	41 GALLON TANK	1	
2	50340A0	2X2 COVER, 8 BOLTS, FOR PVC PIPE	1	
3	LE51M	1/2 HP SEWAGE PUMP 115V, 10' POWER CORD	1	
4	K001162	COVER HARDWARE, WASHER HEAD HEX SCREWS 14 INCLUDED IN KIT	1	
5	K001233	INSPECTION COVER, INCLUDES MOUNTING SCREWS (6)	1	
6	K001101	COVER ASY 2X2, 8 BOLTS, FOR PVC PIPE	1	
7	Pro Series Alarm switch (B10)	REPLACEMENT SWITCH BASED ON SYSTEM LABEL	1	[1]
8	K001054	61130A0 PUMP SWITCH, 10' 115V	1	
9	K001123	QUICKTREE KIT, ROD & CLAMPS ONLY	1	
10	K001108	P372 TANK & 2X2 COVER ASSEMBLY	1	
11	40650A0	2" PVC PIPE FOR 30" TANK, 23-5/8" LONG	1	
	K001054	61130A0 PUMP SWITCH, 10' 115V	1	
	K001144	61130B0 PUMP SWITCH, 25' 115V	1	
	K001134	FLOAT SWITCH, 20FT CORD, INCLUDES 1 SWITCH PER KIT	1	
	K001415	60050D0 SWITCH, 10' PILOT DUTY PIGTAIL	1	

PART NOTES:

- [1] - **NOTE**
ALARM SWITCH KITS
For /A2 Suffix of model number use Part No. K001134
For /A21 Suffix of model number use Part No. K001415
For /A2W Suffix of model number use Part No. K001134