

LE71M2-2 (B61)

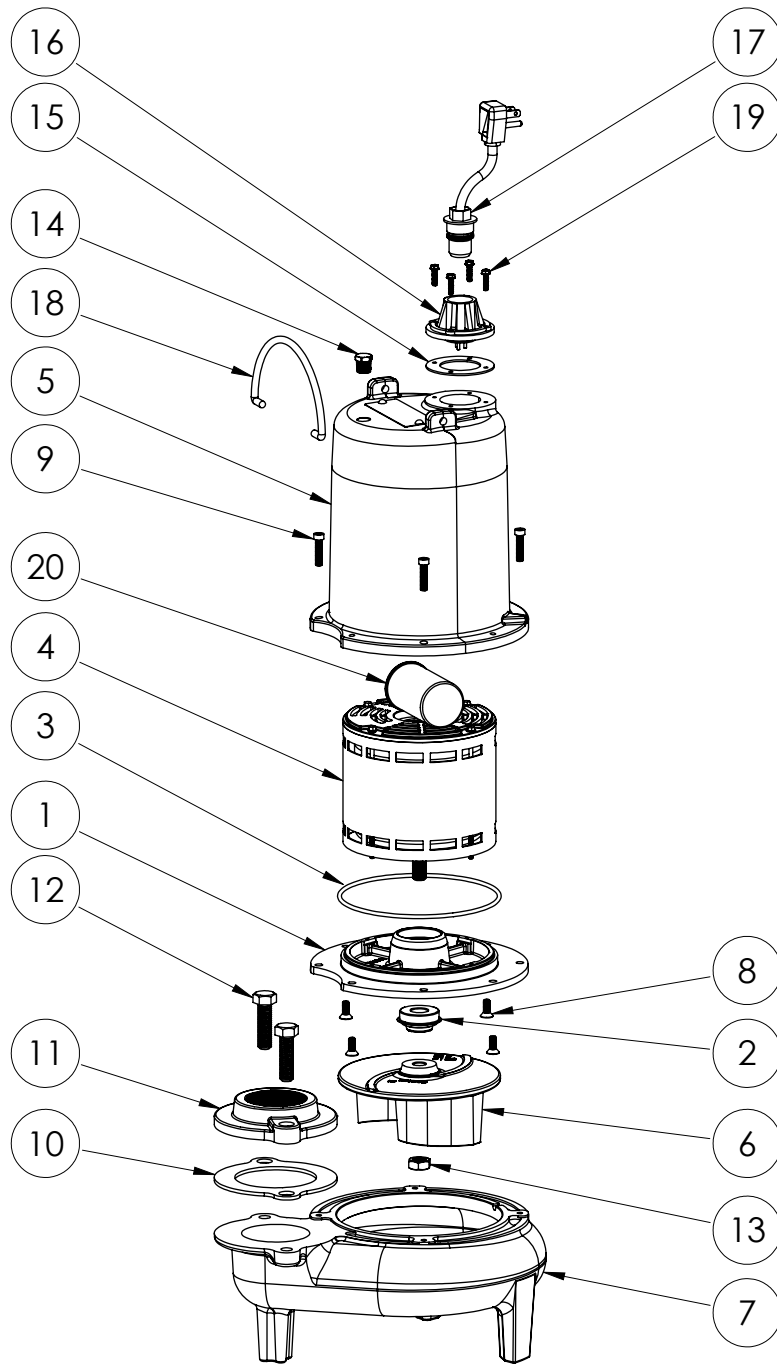

LE71M2-2B61

LE71M2-2**LE71M2-2 (B61)**

#	PART #	DESCRIPTION	QTY	Note
1	532600R	MOTOR SUPPORT PLATE	1	
2	K001717	KIT, 5/8 UNITIZED 5120000 AND LIP SEAL 5860000	1	
3	5617000	O-RING	1	
4	5340000	MOTOR	1	
5	531400R	MOTOR COVER	1	[1]
6	5130000	IMPELLER, CAST IRON	1	
7	531500R	VOLUTE HOUSING	1	
8	8018000	1/4-20 x 5/8 SLOTTED FLAT HEAD BOLT	4	
9	8091000	1/4-20 x 1 HEX SOCKET HEAD BOLT	4	
10	5129000	FLANGE GASKET, FITS 2" OR 3"	1	
11	K001221	2" DISCHARGE KIT	1	
12	8037000	1/2-13 x 1-3/4 STAINLESS STEEL BOLT	2	
13	8046000	1/2-20 HEX STAINLESS STEEL JAM NUT	1	
14	5071000	BRASS OIL PLUG	1	
15	5060000	CORD PLATE GASKET	1	
16	5014000	CORD PLATE	1	
17	K001008	POWER CORD, 115V, 25 FOOT CORD	1	
18	K001095	STAINLESS STEEL HANDLE	1	
19	8064000	#8-32 x 5/8 HEX WASHER HEAD SCREW	4	
20	51190F0	CAPACITOR	1	

PART NOTES:

[1] - Part requires factory authorized service. Contact Liberty Pumps at 1-800-543-2550