



# Smart Pump Range

## Variable Speed Pump Unit



# Table of Contents

1	Introduction and Safety.....	3
1.1	Introduction.....	3
1.2	Safety.....	3
1.2.1	Safety message levels.....	3
1.2.2	User safety.....	4
1.2.3	Wash the skin and eyes.....	5
1.3	Protecting the environment.....	5
2	Transportation and Storage.....	7
2.1	Examine the delivery.....	7
2.1.1	Examine the package.....	7
2.1.2	Examine the unit.....	7
2.2	Unit handling.....	7
2.3	Storage guidelines.....	8
3	Product Description.....	9
3.1	General description.....	9
3.2	Intended use.....	9
3.2.1	Application alternatives.....	9
3.3	Improper use.....	9
3.4	Data plates.....	9
3.4.1	Motor specifications.....	10
3.4.2	Pump specifications.....	11
3.5	Design and layout.....	12
4	Installation.....	15
4.1	Mechanical installation.....	15
4.1.1	Installation area.....	15
4.1.2	Unit installation.....	15
4.2	Hydraulic installation.....	16
4.3	Electrical installation.....	18
4.3.1	Electrical requirements.....	18
4.3.2	Wire types and ratings.....	19
4.3.3	Power supply connection.....	19
5	Operation.....	24
5.1	Precautions.....	24
5.2	Wait times.....	24
6	System Setup and Operation.....	25
6.1	Programming precautions.....	25
6.2	Control panel description.....	25
6.3	Push button descriptions.....	25
6.4	LED description.....	26
6.4.1	POWER (power supply).....	26
6.4.2	STATUS.....	26
6.4.3	SPEED (speed bar).....	26
6.4.4	COM (communication).....	27
6.4.5	Units of measurement.....	28
6.5	Display.....	28

6.5.1 Main Visualization.....	28
6.5.2 Parameters menu visualization.....	29
6.5.3 Alarms and errors visualization.....	30
6.6 Software parameters.....	31
6.6.1 Status parameters.....	31
6.6.2 Settings parameters.....	34
6.6.3 Drive configuration parameters.....	35
6.6.4 Sensor configuration parameters.....	38
6.6.5 RS485 Interface parameters.....	40
6.6.6 Multi-pump configuration parameters.....	41
6.6.7 Test run configuration.....	43
6.6.8 Special parameters.....	43
7 Maintenance.....	45
7.1 Precautions.....	45
8 Troubleshooting.....	46
8.1 Alarm codes.....	46
8.2 Error codes.....	47
9 Technical Specification.....	49
9.1 Electrical and environmental specifications.....	49
9.2 Dimensions and weights.....	51
10 Cybersecurity.....	53

# 1 Introduction and Safety

## 1.1 Introduction

### Purpose of this manual

The purpose of this manual is to provide necessary information for:

- Installation
- Operation
- Maintenance



### CAUTION:

Read this manual carefully before installing and using the product. Improper use of the product can cause personal injury and damage to property, and may void the warranty.

### NOTICE:

Save this manual for future reference, and keep it readily available at the location of the unit.

## 1.2 Safety



### WARNING:

- The operator must be aware of safety precautions to prevent physical injury.
- Operating, installing, or maintaining the unit in any way that is not covered in this manual could cause death, serious personal injury, or damage to the equipment. This includes any modification to the equipment or use of parts not provided by Xylem. If there is a question regarding the intended use of the equipment, please contact a Xylem representative before proceeding.
- Do not change the service application without the approval of an authorized Xylem representative.



### CAUTION:

You must observe the instructions contained in this manual. Failure to do so could result in physical injury, damage, or delays.

### 1.2.1 Safety message levels



#### About safety messages

It is extremely important that you read, understand, and follow the safety messages and regulations carefully before handling the product. They are published to help prevent these hazards:

- Personal accidents and health problems
- Damage to the product
- Product malfunction

#### Definitions

Safety message level	Indication
 <b>DANGER:</b>	A hazardous situation which, if not avoided, will result in death or serious injury

Safety message level	Indication
 <b>WARNING:</b>	A hazardous situation which, if not avoided, could result in death or serious injury
 <b>CAUTION:</b>	A hazardous situation which, if not avoided, could result in minor or moderate injury
 <b>Electrical Hazard:</b>	The possibility of electrical risks if instructions are not followed in a proper manner
<b>NOTICE:</b>	<ul style="list-style-type: none"> <li>• A potential situation which, if not avoided, could result in undesirable conditions</li> <li>• A practice not related to personal injury</li> </ul>

## 1.2.2 User safety

### General safety rules

These safety rules apply:

- Always keep the work area clean.
- Pay attention to the risks presented by gas and vapors in the work area.
- Avoid all electrical dangers. Pay attention to the risks of electric shock or arc flash hazards.
- Always bear in mind the risk of drowning, electrical accidents, and burn injuries.

### Safety equipment

Use safety equipment according to the company regulations. Use this safety equipment within the work area:

- Hard hat
- Safety goggles, preferably with side shields
- Protective shoes
- Protective gloves
- Gas mask
- Hearing protection
- First-aid kit
- Safety devices

#### **NOTICE:**

Never operate a unit unless safety devices are installed. Also see specific information about safety devices in other chapters of this manual.

### Electrical connections

Electrical connections must be made by certified electricians in compliance with all international, national, state, and local regulations. For more information about requirements, see sections dealing specifically with electrical connections.

### Precautions before work

Observe these safety precautions before you work with the product or are in connection with the product:

- Provide a suitable barrier around the work area, for example, a guard rail.
- Make sure that all safety guards are in place and secure.
- Make sure that you have a clear path of retreat.

- Make sure that the product cannot roll or fall over and injure people or damage property.
- Make sure that the lifting equipment is in good condition.
- Use a lifting harness, a safety line, and a breathing device as required.
- Allow all system and pump components to cool before you handle them.
- Make sure that the product has been thoroughly cleaned.
- Disconnect and lock out power before you service the pump.
- Check the explosion risk before you weld or use electric hand tools.

### Precautions during work

Observe these safety precautions when you work with the product or are in connection with the product:

- Never work alone.
- Always wear protective clothing and hand protection.
- Stay clear of suspended loads.
- Always lift the product by its lifting device.
- Beware of the risk of a sudden start if the product is used with an automatic level control.
- Beware of the starting jerk, which can be powerful.
- Rinse the components in water after you disassemble the pump.
- Do not exceed the maximum working pressure of the pump.
- Do not open any vent or drain valve or remove any plugs while the system is pressurized. Make sure that the pump is isolated from the system and that pressure is relieved before you disassemble the pump, remove plugs, or disconnect piping.
- Never operate a pump without a properly installed coupling guard.

### 1.2.3 Wash the skin and eyes

Follow these procedures for chemicals or hazardous fluids that have come into contact with your eyes or your skin:

Condition	Action
Chemicals or hazardous fluids in eyes	<ol style="list-style-type: none"> <li>1. Hold your eyelids apart forcibly with your fingers.</li> <li>2. Rinse the eyes with eyewash or running water for at least 15 minutes.</li> <li>3. Seek medical attention.</li> </ol>
Chemicals or hazardous fluids on skin	<ol style="list-style-type: none"> <li>1. Remove contaminated clothing.</li> <li>2. Wash the skin with soap and water for at least 1 minute.</li> <li>3. Seek medical attention, if necessary.</li> </ol>

## 1.3 Protecting the environment

### Emissions and waste disposal

Observe the local regulations and codes regarding:

- Reporting of emissions to the appropriate authorities
- Sorting, recycling and disposal of solid or liquid waste
- Clean-up of spills

### Exceptional sites



#### **CAUTION: Radiation Hazard**

Do NOT send the product to Xylem if it has been exposed to nuclear radiation, unless Xylem has been informed and appropriate actions have been agreed upon.

### Recycling guidelines

Always follow local laws and regulations regarding recycling.

**Waste and emissions guidelines**

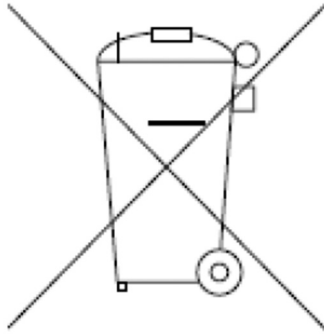

Do not dispose of equipment containing electrical components together with domestic waste.  
Collect it separately in accordance with local and currently valid legislation.



---

# 2 Transportation and Storage

## 2.1 Examine the delivery

### 2.1.1 Examine the package

1. Examine the package for damaged or missing items upon delivery.
2. Record any damaged or missing items on the receipt and freight bill.
3. If anything is out of order, then file a claim with the shipping company.  
If the product has been picked up at a distributor, make a claim directly to the distributor.

### 2.1.2 Examine the unit

1. Remove packing materials from the product.  
Dispose of all packing materials in accordance with local regulations.
2. To determine whether any parts have been damaged or are missing, examine the product.
3. If applicable, unfasten the product by removing any screws, bolts, or straps.  
Use care around nails and straps.
4. If there is any issue, then contact a sales representative.

## 2.2 Unit handling



---

**WARNING:**

Assembled units and their components are heavy. Failure to properly lift and support this equipment can result in serious physical injury and/or equipment damage. Lift equipment only at the specifically identified lifting points. Lifting devices such as eyebolts, slings, and spreaders must be rated, selected, and used for the entire load being lifted.

---



---

**WARNING: Crush Hazard**

Always lift the unit by its designated lifting points.  
Use suitable lifting equipment and ensure that the product is properly harnessed.  
Wear personal protective equipment.  
Stay clear of cables and suspended loads.

---

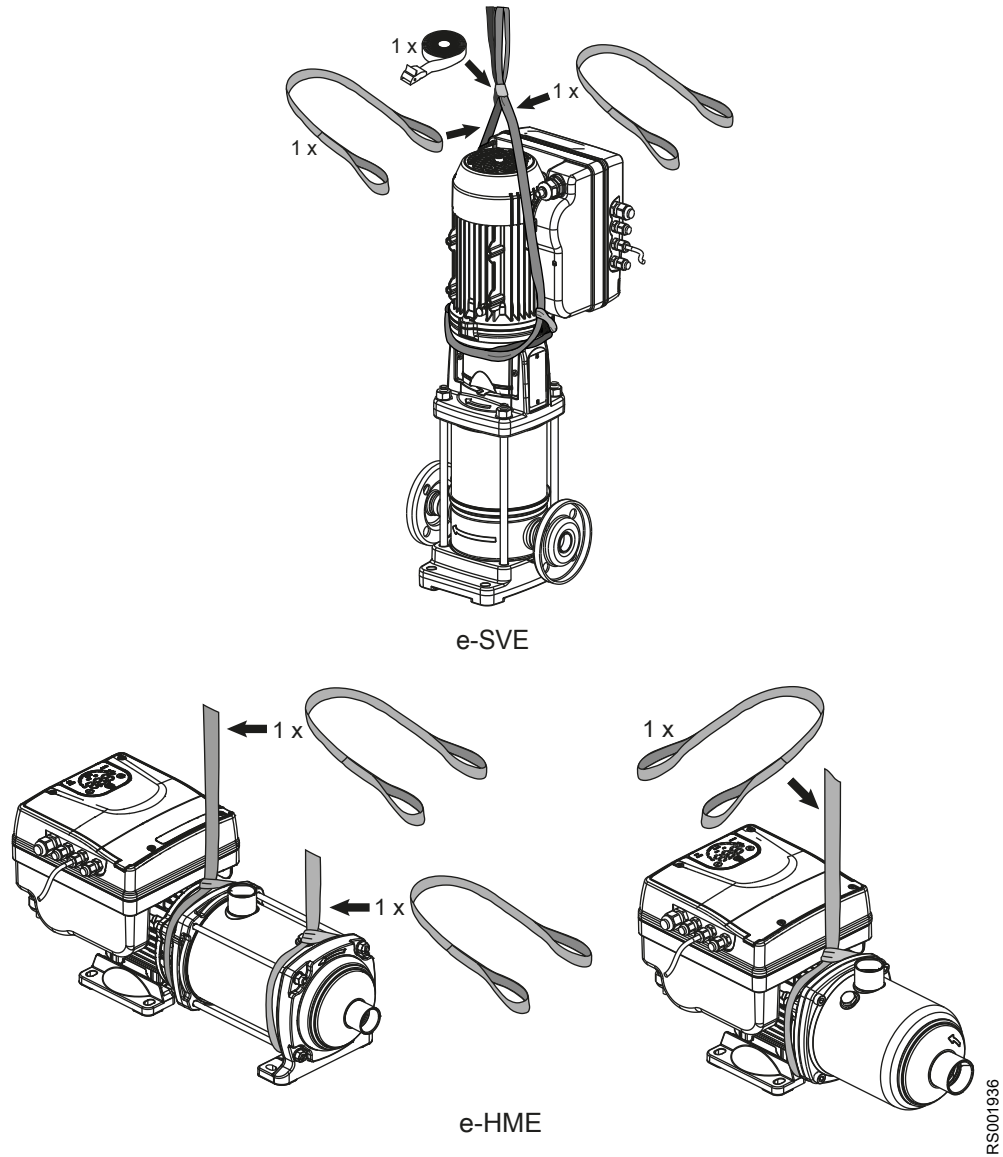

Figure 1: Lifting

## 2.3 Storage guidelines

### Storage location

The product must be stored in a covered and dry location free from heat, dirt, and vibrations.

---

**NOTICE:**

Protect the product against humidity, heat sources, and mechanical damage.

---

**NOTICE:**

Do not place heavy weights on the packed product.

---

### Ambient temperature

Store this product at an ambient temperature between  $-13^{\circ}\text{F}$  ( $-25^{\circ}\text{C}$ ) and  $+149^{\circ}\text{F}$  ( $+65^{\circ}\text{C}$ ) and a relative humidity between 5% and 95%.

# 3 Product Description

## 3.1 General description

This product is a variable speed pump unit and can be installed vertically or horizontally. It is non self-priming.

## 3.2 Intended use

The product can be used to pump:

- Cold water
- Hot water

Refer to the standard installation, Operation, and Maintenance Manual for pump design specification.

The variable speed pump units are made for the following applications:

- Pressure, level, and flow regulation applications,
- Single and multi-pump irrigation systems.

### 3.2.1 Application alternatives

#### **Actuator (constant speed)**

The unit operates as an actuator according to speed set point; this is done through user interface, the corresponding analog input or the communication bus.

#### **Controller (constant pressure)**

This mode is set as the default operating mode, and is used for single pump operating units.

#### **Cascade serial / Cascade synchronous**

The units are connected via the RS485 interface and communicate via the provided protocol. The combination of the different units which are used in a multi-pump system depends on the system requirements.

It is possible to run all pumps in cascade serial mode and cascade synchronous mode as well. If one unit fails, then each pump of the system can become the lead pump and take control.

## 3.3 Improper use

The product must not be used for closed loop systems.

## 3.4 Data plates

The data plate is a label showing:



- The main product details
- The identification code

#### **Approval and certifications**





For the approvals see the motor data plate.

### 3.4.1 Motor specifications

#### Motor data plates

 XYLEM SERVICE ITALIA SRL VIA VITTORIO LOMBARDI 14 36075 MONTECCHIO MAGGIORE (VI) - ITALY Reg. No. 0752056096		 MADE IN ITALY E481622	
Type : [ P. 1 ]	Code : [ P. 2 ]	S/N : [ P. 3 ]	
V : [ P. 4 ]	kW : [ P. 8 ]	Electronically Protected	Tamb : [ P. 15 ]
Hz : [ P. 5 ]	HP : [ P. 9 ]	CL : [ P. 12 ]	ENC : [ P. 16 ]
A : [ P. 6 ]	rpm : [ P. 10 ]	CODE : [ P. 13 ]	IP : [ P. 17 ]
PF : [ P. 7 ]	η <sub>230V</sub> : [ P. 11 ]	Duty : [ P. 14 ]	[ P. 18 ] kg

Position	Description	Notes
1	Product/model name	
2	Product part number	
3	Serial number	
4	Input voltage range	1~ 208-240V; 3~ 208-230 / 380-460 ; 3 HP, 3~ 380-460
5	Input frequency	50/60Hz
6	Rated input current range	
7	Rated power factor	
8	Rated shaft power [kW]	
9	Rated shaft power [HP]	
10	Rated power speed range	3000÷3600rpm
11	Rated efficiency	
12	Insulation class	155 (F) – LW155-1
13	NEMA KVA Code	
14	Duty	S1 - Continuous
15	Max ambient temperature	
16	Enclosure type	3R
17	IP grade	
18	Unit weight	
19	datamatrix: • ECC type 200 • dot size 3pt • min size 5.5x5.5mm	string composition: A#B where: • A = serial number (date of production-progressive number) • B = product part number • # = separator
	Product UL recognized for US and Canada	Mark applied only on US models

 Code: [ P. 1 ] S/N: [ P. 2 ]		
kW V A PF min <sup>1</sup> IES η <sub>3/4</sub>		 [ P. 4 ] C3
P. 3		 [ P. 5 ] C3 [ P. 6 ] TG639 [ P. 7 ]

Position	Description	Notes
1	Product part number	
2	Serial number	
3	Performance date	
4	DE bearing size	
5	NDE bearing size	

Position	Description	Notes
6	Network ID	parameters for wireless connections with expansion card (not available yet)
7	Password	

### 3.4.2 Pump specifications

#### e-HME nameplate

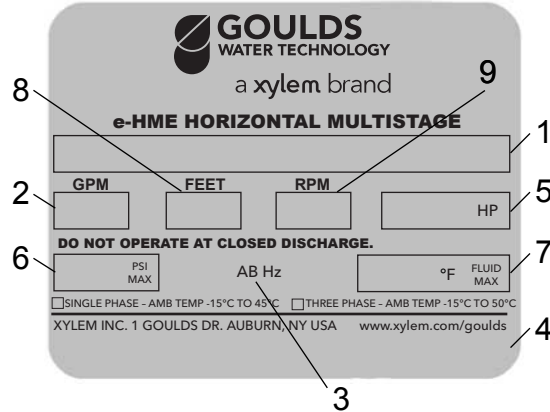

1. Catalog number
2. Capacity range
3. Rated Hz
4. Pump serial number
5. Rated horsepower
6. Maximum operating pressure
7. Maximum fluid temperature
8. TDH range
9. Rated Speed

#### e-SVE nameplate

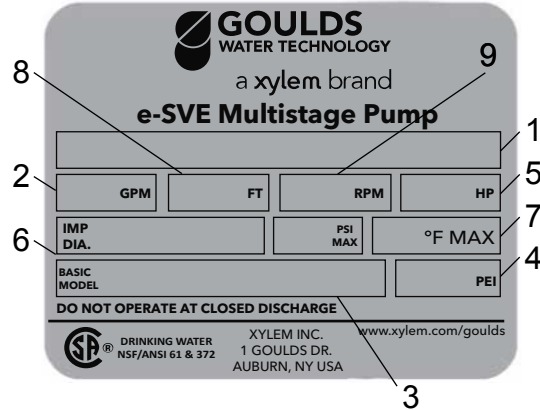

1. Catalog number
2. Capacity Range
3. Model Number
4. Pump energy index
5. Rated horsepower
6. Impeller diameter
7. Maximum fluid temperature
8. TDH range
9. Rated Hz

e-AB3 label

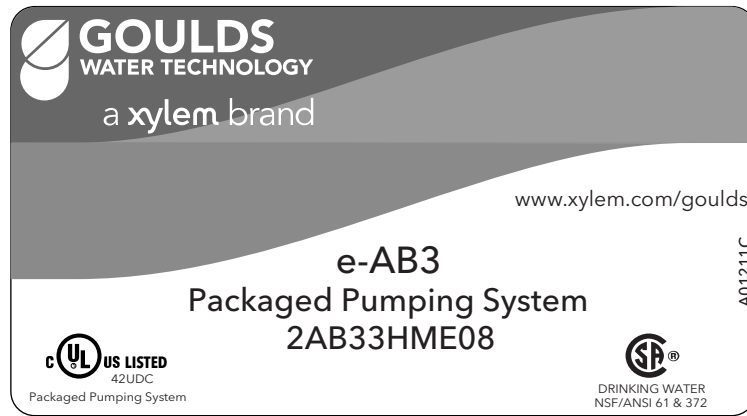

e-SVI nameplate

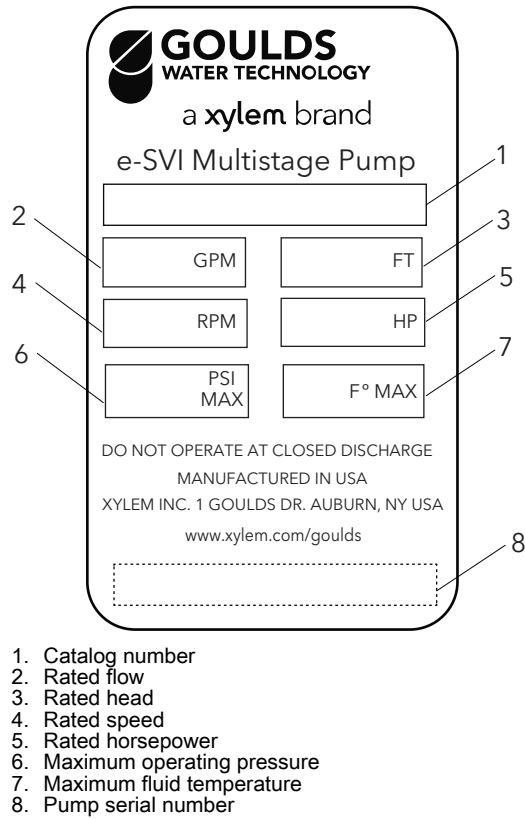

### 3.5 Design and layout

The unit can be fitted with the features required by the application.

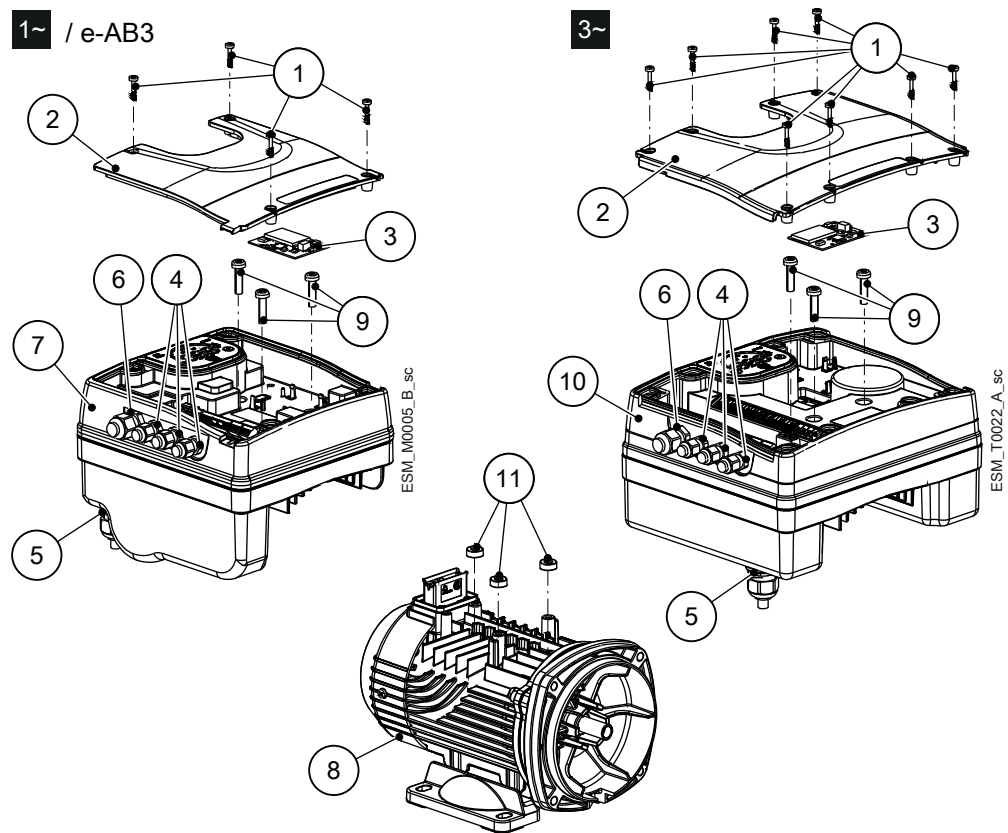

Figure 2: Main components — single-phase and three-phase models

Table 1: Description of components

Position number	Description	Tightening torque $\pm 15\%$	
		[Nm]	[in•lbs]
1	Screw	1.4	12.4
2	Terminal box cover	—	—
3	Optional module with strip	—	—
4	M12 I/O cable gland	2.0	17.7
5	M20 cable gland for power supply cables	2.7	23.9
6	M16 I/O cable guard	2.8	24.8
7	Drive (single-phase model)	—	—
8	Motor	—	—
9	Screw	6.0	53.1
10	Drive (three-phase model)	-	—
11	Spacer	—	—

### Pre-assembled factory components

Component		Quantity	Notes
Plug for cable gland	M12	3	
	M16	1	

Component		Quantity	Notes	
	M20	1		
Cable gland and lock nut	M12	3	Cable out diameter	0.145–0.275 in (3.7 to 7.0 mm)
	M16	1		0.177–0.394 in (4.5 to 10.0 mm)
Cable gland	M20	1		0.265–0.512 in (7.0 to 13.0 mm)

**Optional components**

Table 2: Optional components

Component	Description
Sensors	The following sensors can be used with the unit: <ul style="list-style-type: none"> <li>• Level-sensor</li> </ul>
RS485 Module	For the connection of a multi-pump system to a supervision system, via cable (Modbus or BACnet MS/TP protocol)
Adaptor	M20 Metric to 1/2" NPT Adaptor (item is always supplied for US market)



# 4 Installation

## 4.1 Mechanical installation

### 4.1.1 Installation area



---

**DANGER:**

Potentially explosive atmosphere hazard. The operation of the unit in environments with potentially explosive atmospheres or with combustible dusts (e.g.: wood dust, flour, sugars and grains) is strictly forbidden.

Do not use the unit to handle hazardous or flammable liquid.

---



---

**WARNING:**

- Always wear personal protective equipment.
  - Always use suitable working tools.
  - When selecting the place of installation and connecting the unit to the hydraulic and electric power supplies, strictly comply with current regulations.
  - Ensure that the environmental / ingress protection rating of the unit (Type 3R, IP 55) is suitable for the installation environment.
  - Do NOT install this pump in swimming pools or marine areas. Failure to follow these instructions could result in serious personal injury, death and/or property damage.
- 



---

**CAUTION:**

- Environmental / ingress protection: to ensure the Type 3R (IP55) protection index is achieved, make sure that the unit is closed correctly.
  - Before opening the terminal box cover, make sure that there is no water in the unit.
  - Make sure that all unused cable glands and cable holes are correctly sealed.
  - Make sure that the plastic cover is correctly closed.
  - Do not leave the terminal box without a cover to avoid the risk of damage due to contamination.
  - Risk of electrical shock or burn. The equipment manufacturer has not evaluated this unit for use in swimming pools.
  - This pump has been evaluated for use with water only.
- 

### 4.1.2 Unit installation

- See the Quick Startup Guide instructions.
- Position the unit as shown in Figure 10.
- Install the unit according to the liquid flow of the system.
- The arrows on the pump body indicate the flow and the rotation direction.
- The standard rotation direction is clockwise (looking at the fan cover).
- Always install a backflow-prevention device on the suction side.
- Always install the pressure sensor on the delivery side, after the check valve.

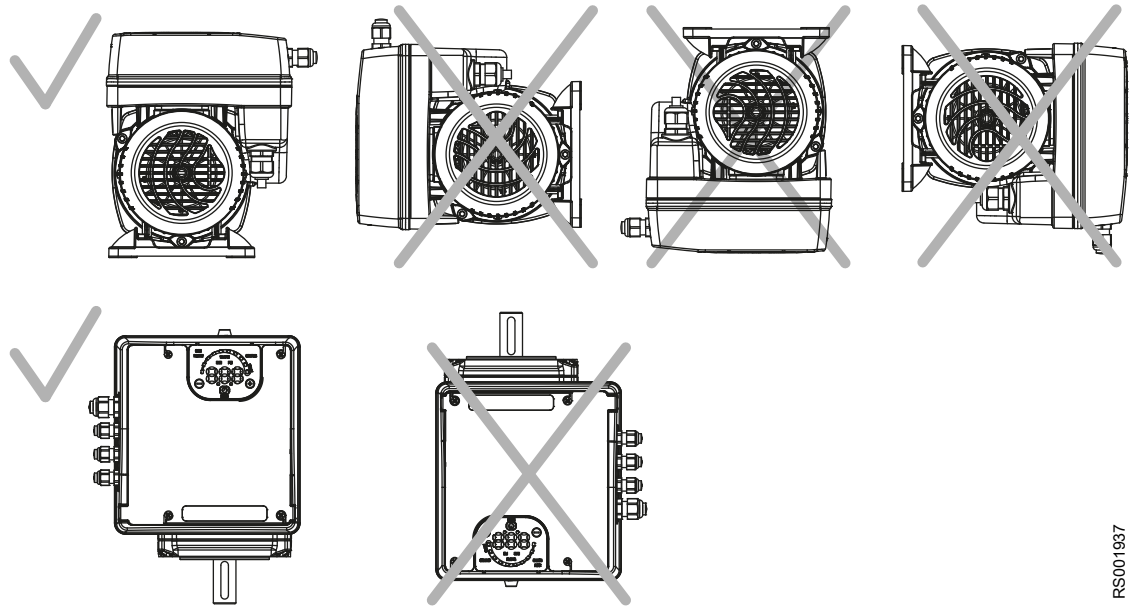

Figure 3: Permitted positions

RS001937

**Minimum spacing**

Area	e-SM Drive model	Free distance
Above the unit	103..105..107..111..115	> 10.2 in (260 mm)
Center-distance between units (to ensure space for cabling)	103..105..107..111..115	> 10.2 in (260 mm)
	303..305..307..311..315..322	≥ 11.8 in (300 mm)

**4.2 Hydraulic installation**

- Install a pressure relief valve sufficient to limit the system pressure below the maximum working pressure of the pump and tank (the minimum of the two). The pressure relief valve must be plumbed to a drain to prevent damage due to flooding.
- Check that the sum of the pressure intake (for example, for the connection with a municipal line or pressure tank) and the maximum pressure of the pump does not exceed the value of the maximum permitted operating pressure of the controller or of the pump (the minimum of the two).
- In cases where the water level is below the suction of the pump (lifting water), install a check valve (foot valve) on the suction of the pump to make sure that the pump stays primed.
- Install a gate valve to allow maintenance of the controller and pump or of the pressure tank.
- It is advisable to install a tap for use during commissioning of the system if there is not already an outlet near the pump.
- The controller plus electric pump can be used to connect the system directly to the municipal supply line or to take water from a primary water supply tank.
- If connecting to a municipal supply, follow the applicable provisions set by the authorities having jurisdiction.
- It is advisable to install a pressure switch on the suction side for turning off the pump if there is low pressure in the in-coming supply line. Protects against dry running.
- If connecting to a primary water supply tank, it is advisable to install a float for turning off the pump when there is no water. Protects against dry running.
- Refer to the instruction manual of the pump for further information.

The following images show a single pump system and a multi-pump system respectively.

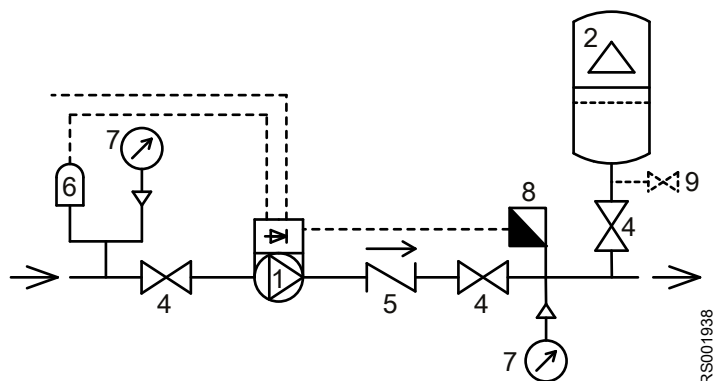

Figure 4: Single-pump system

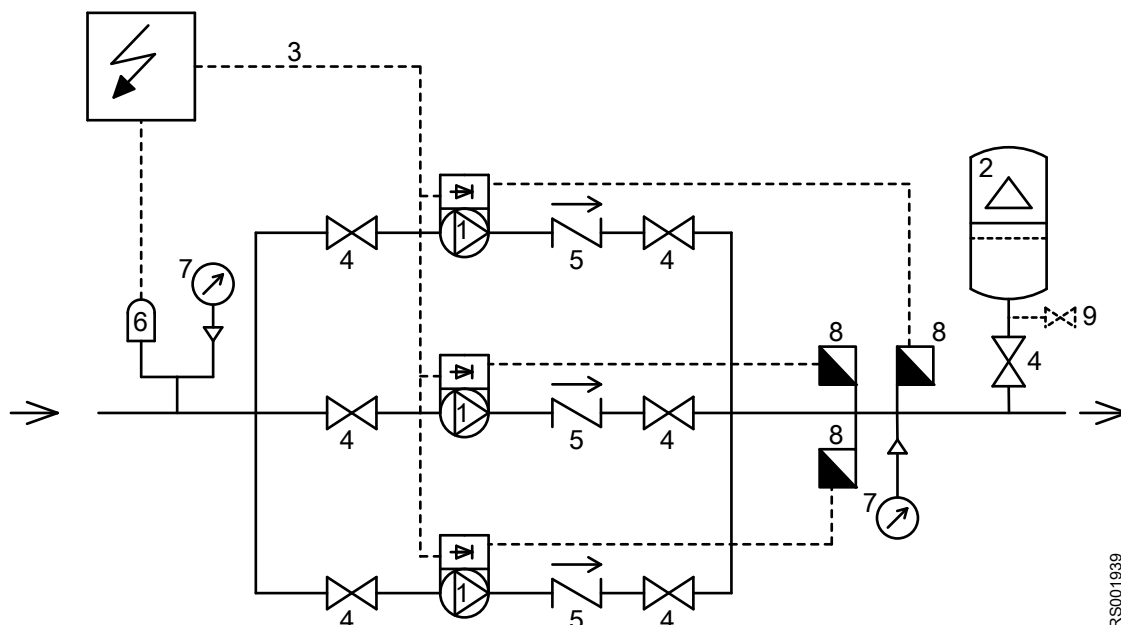

Figure 5: Multi-pump system

1. Pump with e-SM Smart Motor drive
2. Diaphragm pressure tank
3. Distribution panel
4. On-Off valve
5. Check valve
6. Low water control
7. Pressure gauge
8. Pressure sensor
9. Drain tap

### Pressure tank

On the pump delivery side there is a diaphragm pressure tank, which gives the possibility of maintaining the pressure inside the piping when the system is not being used. The unit stops the pump from continuing to run at zero demand and reduce the size of the tank that is required for supply purposes.

Select a tank suitable for the system pressure, and pre-load it in accordance with the values indicated in the Quick Start Guide.

## 4.3 Electrical installation



---

### Electrical Hazard:

The connection to the electric power supply must be completed by an electrician possessing the technical-professional requirements outlined in the current regulations.

---

### 4.3.1 Electrical requirements

- The local regulations in force overrule specified requirements listed below.

#### Electrical connection checklist

Check that the following requirements are met:

- The electrical leads are protected from high temperature, vibrations, and collisions.
  - The current type and voltage of mains connection must correspond to the specifications on the data plate on the pump.
  - The supply power line is provided with:
    - A disconnect switch with a contact gap of at least 0.12 in (3 mm) must be installed between the electrical service panel and controller.
- 



### WARNING:

To reduce the risk of electric shock, install only on a circuit protected by a ground-fault circuit interrupter (GFCI)

---

#### The electrical control panel checklist

### NOTICE:

The electrical service panel must match the ratings of the electric pump. Inappropriate combinations do not guarantee the protection of the unit.

---

Check that the following requirements are met:

- The electrical service panel must protect the converter and the pump against short circuit. A time lag fuse or a circuit breaker (Type C model is suggested) can be used to protect the pump. Use only time-delay fuses to protect the pump.
  - The pump has built-in overload and thermal protection. No additional overload protection is required.
- 



### Electrical Hazard:

Before starting work on the unit, make sure that the unit and the control panel are isolated from the power supply and cannot be energized.

---

#### Grounding (earthing)



### Electrical Hazard:

- Always connect the external protection conductor to the ground terminal before attempting to make any other electrical connections.
  - Connect all the electric accessories of the pump and the motor to the ground, making sure that the connections are completed correctly.
  - Check that the protection conductor (ground) is longer than the phase conductors; in case of accidental disconnection of the power supply conductor, the protection conductor (ground) must be the last one to detach itself from the terminal.
- 

Use a cable with several strands to reduce electric noise.

### 4.3.2 Wire types and ratings

- All cables must comply with local and national standards in terms of section and ambient temperature.
- To ensure compliance with UL (Underwriters Laboratories) regulations, all power supply connections must be completed using the following types of copper cables with minimum resistance 167°F (+75°C): THW, THWN
- Cables must never enter into contact with the motor body, the pump, or the piping.
- The wires that are connected to the power supply terminals and the fault signal relay (NO, C) must be separated from the other wires by reinforced insulation.

Table 3: Electric connection cables

Smart motor models	Power supply input cable + PE		Tightening torque	
	Wire numbers x Max. copper section	Wire numbers x Max. AWG	Mains and motor cable terminals	Earth conductor
103, 105, 107, 111, 115	3 x 0.0032 sq. in 3 x 2.08 mm <sup>2</sup>	3 x 16 AWG with ferrules 14 AWG without	Spring connectors	Spring connectors
303, 305, 307, 311, 315, 322	4 x 0.0032 sq. in 4 x 2.08 mm <sup>2</sup>	4 x 16 AWG with ferrules / 14 AWG without	7.1 lbf-in 0.8 Nm	26.6 lbf-in 3 Nm

### Control cables

External volt free contacts must be suitable for switching < 10 VDC.

#### NOTICE:

- Install the control cables separate from the power supply cables and the fault signal relay cable
- If the control cables are installed in parallel with the power supply cable or the fault signal relay, the distance between the cables must exceed 8 in (200 mm)

Do not intersect the power supply cables; should this be necessary, a 90° intersection angle is permitted.

Table 4: Recommended control cables

Smart motor control cables	Wires number x Max. copper Section	AWG	Tightening torque
All I/O conductors	0.00012–0.0023 sq.in 0.75–1.5 mm <sup>2</sup>	18–16 AWG	5.4 lbf-in 0.6 Nm

### 4.3.3 Power supply connection



#### Electrical Hazard:

Contact with electric components may cause death, even after the unit has been switched off. Before any interventions on the unit, the network voltage and any other input voltages must be disconnected for 5 minutes.

Table 5: Power supply wiring procedure

	Reference
1. Open the terminal box cover (2) by removing the screws (1).	Fig. 9
2. Insert the power cable in the M20 cable gland (5)	

<ol style="list-style-type: none"> <li>1. Connect the cable according to the wiring diagram.</li> <li>2. Connect the earth conductor (mass), making sure that it is longer than the phase conductors.</li> <li>3. Connect the phase leads.</li> </ol>	Fig. 14
<ol style="list-style-type: none"> <li>1. Close the cover (2) and tighten the screws (1).</li> </ol>	Fig. 9

Table 6: I/O wiring procedure

	Reference
<ol style="list-style-type: none"> <li>1. Open the terminal box cover (2) by removing the screws (1).</li> </ol>	Fig. 9
<ol style="list-style-type: none"> <li>1. Connect the cable according to the wiring diagram.</li> </ol>	Fig. 15
<ol style="list-style-type: none"> <li>1. Close the cover (2) and tighten the screws (1).</li> </ol>	Fig. 9

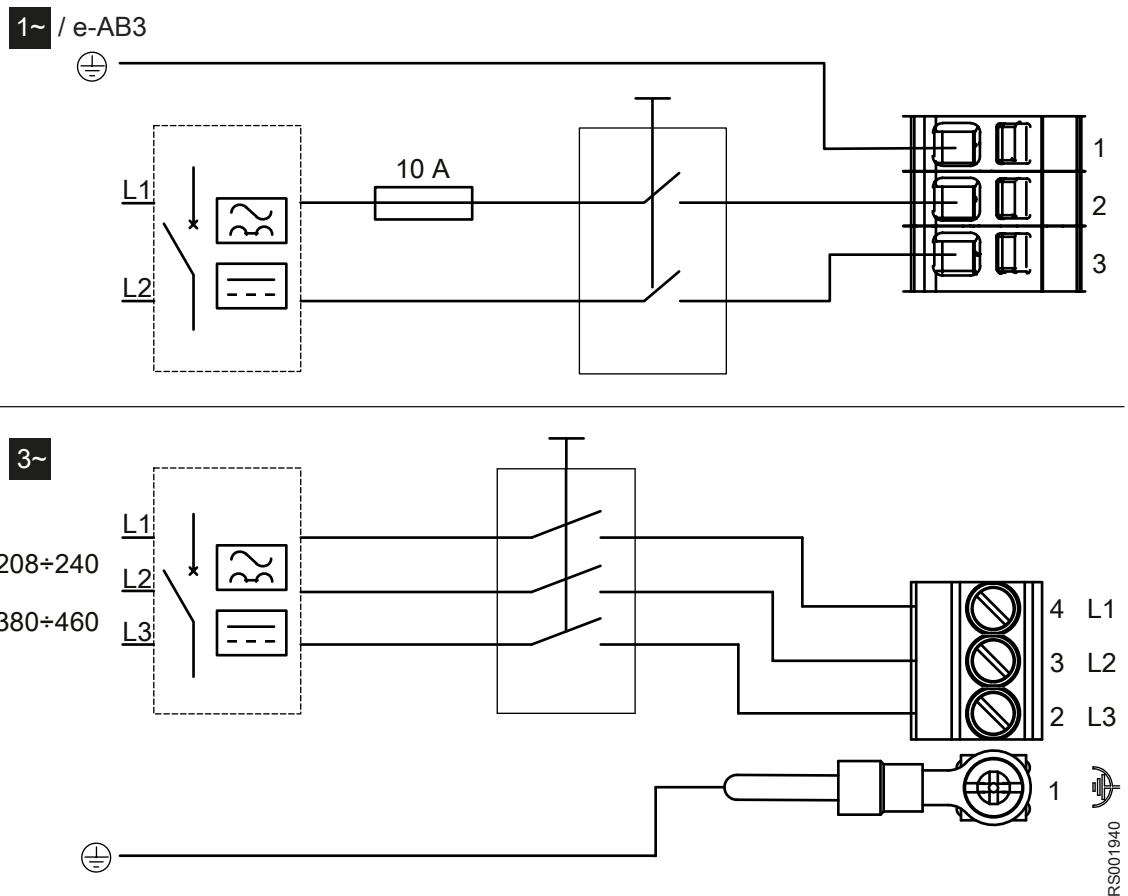

Figure 6: Wiring diagrams

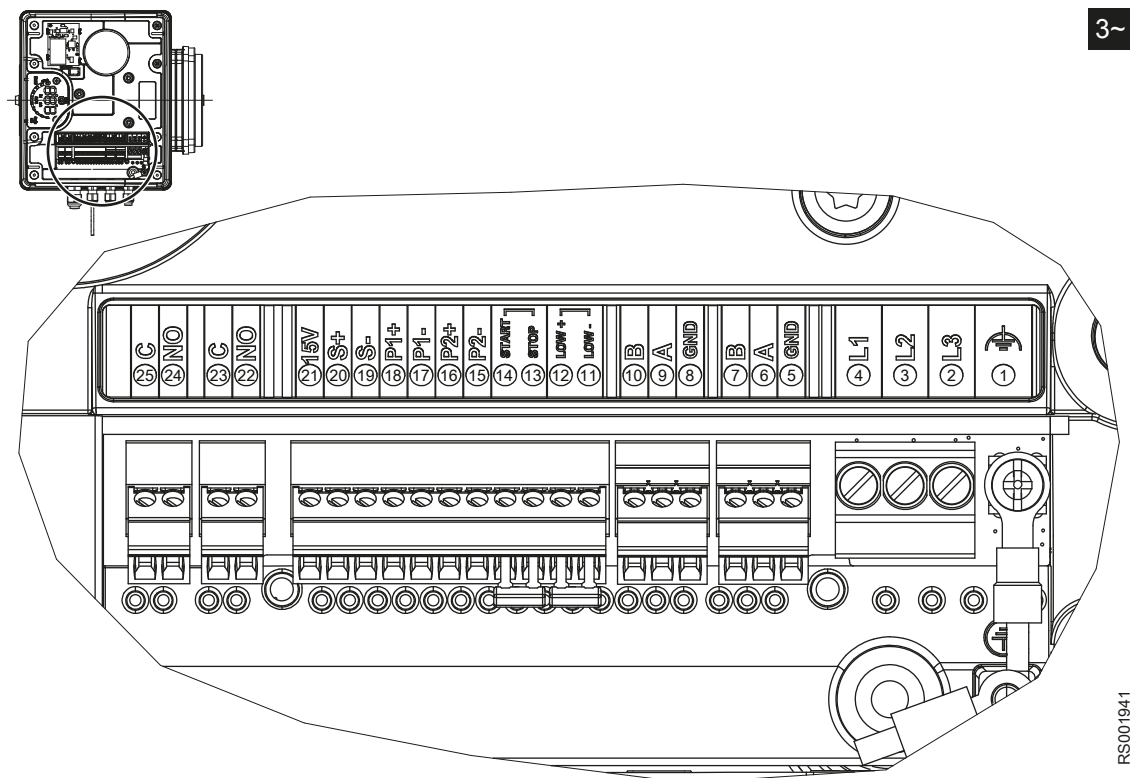
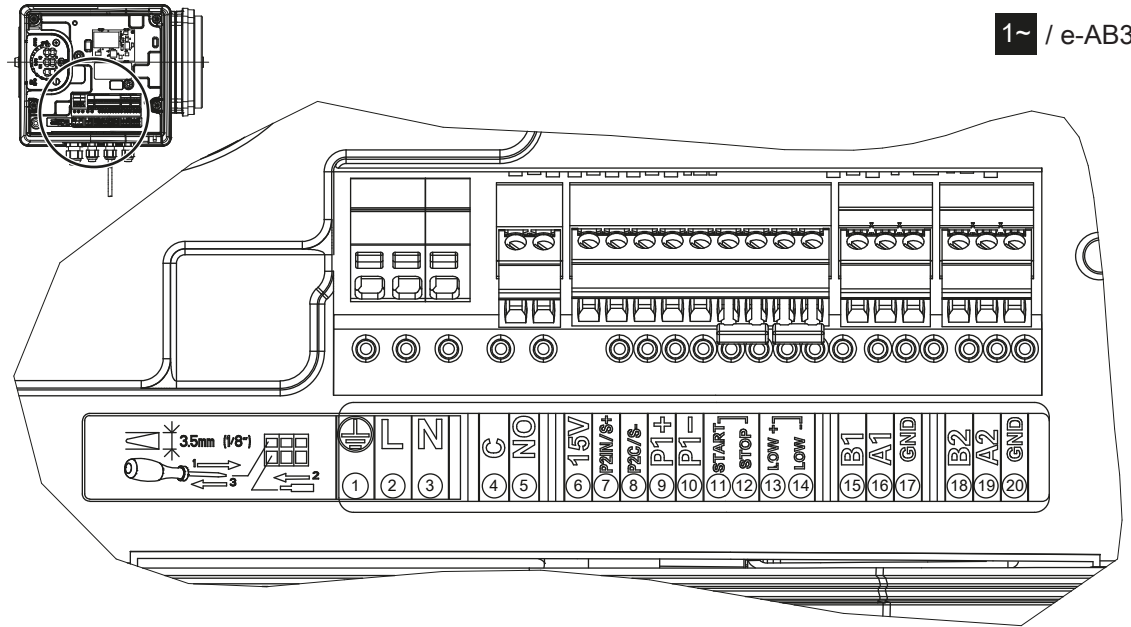

Figure 7: Connection label

Table 7: 1~ I/O terminals

Item	Terminals	Ref.	Description	Notes
Fault Signal	C	4	COM - error status relay	
	NO	5	NO - error status relay	
Auxiliary Voltage Supply	15V	6	Auxiliary voltage supply +15 VDC	15VDC, $\Sigma$ max. 100 mA

Item	Terminals	Ref.	Description	Notes
Analog input 0-10V	P2IN/S+	7	Actuator mode 0-10 V input	0-10 VDC
	P2C/S-	8	GND for 0-10 V input	GND, electronic ground (for S+)
External Pressure sensor [also Differential]	P1+	9	Power supply external sensor +15 VDC	15VDC, $\Sigma$ max. 100 mA
	P1-	10	External sensor 4-20 mA input	4-20 mA
External Start/Stop	START	11	External ON/OFF input reference	Default short circuited Pump is enabled to RUN
	STOP	12	External ON/OFF input	
External Lack of Water	LOW+	13	Low water input	Default short circuited Lack of water detection: enabled
	LOW-	14	Low water reference	
Communication bus	B1	15	RS485 port 1: RS485-1N B (-)	ACT, HCS control mode: RS 485 port1 for external communication MSE, MSY control mode: RS 485 port 1 for multi-pump systems
	A1	16	RS485 port 1: RS485-1P A (+)	
	GND	17	Electronic GND	
Communication bus	B2	18	RS485 port 2: RS485 port 2: RS485-2N B (-) active only with optional module	RS 485 port2 for external communication
	A2	19	RS485 port 2: RS485 port 2: RS485-2P A (+) active only with optional module	
	GND	20	Electronic GND	

Table 8: 3~ I/O terminals

Item	Terminals	Ref.	Description	Notes
Fault signal	C	25	COM - error status relay	In case of power cables: use the M20 cable gland
	NO	24	NO - error status relay	
Motor running signal	C	23	Common contact	In case of power cables: use the M20 cable gland
	NO	22	Normally open contact	
Auxiliary Voltage Supply	15V	21	Auxiliary voltage supply +15 VDC	15VDC, $\Sigma$ max. 100 mA
Analog input 0-10V	S+	20	Actuator mode 0-10 V input	0-10 VDC
	S-	19	GND for 0-10 V input	GND, electronic ground (for S+)



Item	Terminals	Ref.	Description	Notes
External Pressure sensor [also Differential]	P1+	18	Power supply external sensor +15 VDC	15VDC, $\Sigma$ max. 100 mA
	P1-	17	External sensor 4-20 mA input	4-20 mA
External pressure sensor	P2+	16	Power supply external sensor +15 VDC	15VDC, $\Sigma$ max. 100 mA
	P2-	15	Sensor 4-20 mA input	4-20 mA
External Start/Stop	Start	14	External ON/OFF input	Default short circuited Pump is enabled to RUN
	Stop	13	External ON/OFF input reference	
External Lack of Water	LoW+	12	Low water input	Default short circuited Lack of water detection: enabled
	LoW-	11	Low water reference	
Communication Bus	B2	10	RS485 port 2: RS485 port 2: RS485-2N B (-) active only with optional module	RS 485 port2 for external communication
	A2	9	RS485 port 2: RS485 port 2: RS485-2P A (+) active only with optional module	
	GND	8	Electronic GND	
Communication Bus	B1	7	RS485 port 1: RS485-1N B (-)	ACT, HCS control mode: RS 485 port 1 for external communication Control mode MSE, MSY: RS 485 port 1 for multi-pump systems
	A1	6	RS485 port 1: RS485-1P A (+)	
	GND	5	Electronic GND	

# 5 Operation

## 5.1 Precautions

In case of coexistence of two or more of the following conditions:

- high ambient temperature
- high water temperature
- duty points insisting on unit maximum power
- persisting undervoltage of mains,

the life of the unit may be jeopardized and/or derating may occur: for further information contact Xylem or the Authorised Distributor.

## 5.2 Wait times



### Electrical Hazard:

Contact with electric components may cause death, even after the unit has been switched off. Before any interventions on the unit, the network voltage and any other input voltages must be disconnected for the minimum time indicated in Table 9.

Table 9: Wait times

Smart motor	Minimum waiting time in minutes
	4
	5



### Electrical Hazard:

Frequency converters contain DC-link capacitors that can remain charged even when the frequency converter is not powered.

To avoid electrical hazards:

- Disconnect the AC power supply
- Disconnect all types of permanent magnet motors
- Disconnect all DC-link remote power supplies, including the battery backups, the Uninterrupted Power Supply units and the DC-link connections to other frequency converters
- Wait for the capacitors to discharge completely before carrying out any maintenance or repairs; see Table 9 (Wait times) for the waiting times

# 6 System Setup and Operation

## 6.1 Programming precautions

### NOTICE:

- Carefully read and adhere to the following instructions before starting the programming activities to avoid incorrect settings that can cause malfunctions.
- All modifications must be done by qualified technicians.

## 6.2 Control panel description

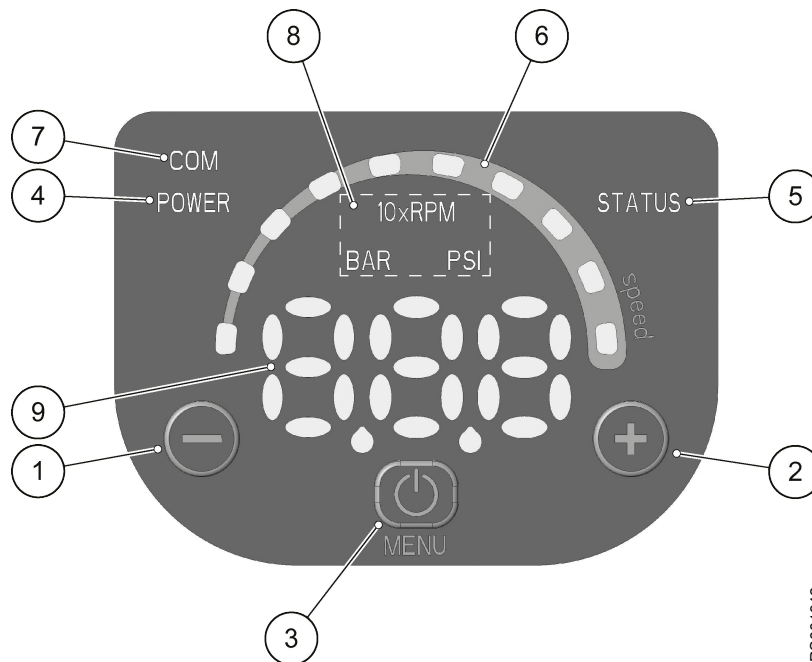









Figure 8: Control panel

Position number	Description	Parameter
1	Decrease button	6.2
2	Increase button	6.2
3	START/STOP and menu access button	6.2
4	POWER LED	6.3.1
5	Status LED	6.3.2
6	Speed LED bar	6.3.3
7	Communication LED	6.3.4
8	Unit of measure LEDs	6.3.5
9	Display	6.4

## 6.3 Push button descriptions

Refer to [Control panel description](#) on page 25 for the location of the push buttons.

Push button	Function
	<ul style="list-style-type: none"> <li>Main view (see parameter 6.4.1): decreases the required value for the selected control mode</li> <li>Parameter menu (see parameter 6.4.2): decreases the displayed parameter index</li> <li>Parameter view / editing (see parameter 6.4.2): decreases the value of the displayed parameter</li> <li>Zero pressure auto-calibration (see parameter 6.5, P44): automatic calibration of the pressure sensor.</li> </ul>
	<ul style="list-style-type: none"> <li>Main view (see parameter 6.4.1): increases the required value for the selected control mode</li> <li>Parameter menu (see parameter 6.4.2): increases the displayed parameter index</li> <li>Parameter view / editing (see parameter 6.4.2): increases the value of the displayed parameter</li> <li>Zero pressure auto-calibration (see parameter 6.5, P44): automatic calibration of the pressure sensor.</li> </ul>
	<ul style="list-style-type: none"> <li>Main view (see parameter 6.4.1): START/STOP the pump</li> <li>Parameter menu (see parameter 6.4.2): switches to parameter view / editing</li> <li>Parameter view / editing (see parameter 6.4.2): saves the value of the parameter.</li> </ul>
 long press	<ul style="list-style-type: none"> <li>Main view (see parameter 6.4.2): switches to parameter selection</li> <li>Parameters Menu: switches to Main Visualization</li> </ul>
 and 	Main view: alternates between Speed and Head units of measure (see parameter 6.4.1).
 and 	Main view: alternates between Speed and Head units of measure (see parameter 6.4.1).

## 6.4 LED description

### 6.4.1 POWER (power supply)

When ON (POWER) the pump is powered and the electronic devices are operational.

### 6.4.2 STATUS

LED	Status
Off	Pump unit stopped
Green steady	Pump unit in operation
Flashing green and orange	Non-locking alarm with the pump unit in operation
Orange steady	Non-locking alarm with the pump unit stopped
Red steady	Locking error, the pump unit cannot be started

### 6.4.3 SPEED (speed bar)

The speed bar consists of 10 LEDs, each representing the speed range between parameter P27 (minimum speed) and parameter P26 (maximum speed) from 0-100% in intervals of 10%.

LED bar	Status
On	Motor in operation; the speed corresponds to the percentage step represented by the LEDs ON in the bar (for example, 3 LEDs ON = speed 30%)
First LED flashing	Motor in operation; the speed is lower than the absolute minimum, P27
Off	Motor stopped

#### 6.4.4 COM (communication)

##### Condition 1

- The communication bus protocol is the Modbus RTU protocol; the P50 parameter is set to the Modbus value
- No optional communication module is used.

LED	Status
Off	The unit cannot detect any valid Modbus messages on the terminals provided for the communication bus
Green steady	The unit has detected a communication bus on the provided terminals and has recognized the correct addressing.
Green flashing	The unit has detected a communication bus on the provided terminals and has not been addressed correctly
From green steady to off	The unit has not detected a valid Modbus RTU message for at least 5 seconds.
From green steady to flashing	The unit has not been addressed correctly for at least 5 seconds.

##### Condition 2

- The communication bus protocol is the BACnet MS/TP protocol; the P50 parameter is set to the BACnet value
- No optional communication module is used.

LED	Status
Off	The unit has received no valid requests from other BACnet MS/TP devices for at least 5 seconds.
On steady	The unit is exchanging information with another BACnet MS/TP device.

##### Condition 3

- A multi-pump control mode is selected (e.g. MSE or MSY)
- No optional communication module is used.

LED	Status
Off	The unit has received no valid requests from other pumps through the multi-pump BUS for at least 5 seconds
On steady	The unit is exchanging information with another pump through the multi-pump BUS.

##### Condition 4

The optional communication module is being used.



LED	Status
Off	RS485 or wireless connection faulty or missing.
Flashing	The unit is exchanging information with the communication module.











### 6.4.5 Units of measurement

LED on	Measurement active	Notes
10xRPM	Impeller rotation speed	The display shows the speed in 10xRPM
BAR	Hydraulic head	The display shows the value of the head in bar
PSI		The display shows the value of the head in psi

## 6.5 Display

### 6.5.1 Main Visualization







Display	Mode	Description
OFF	OFF	Contacts 11 and 12 (see parameter 5.4) are not short-circuited. Note: It has lower display priority than STOP mode.
STP	STOP	Pump stopped manually. If the pump is switched on after setting P04 = OFF (see Par. 6.5.1), it is stopped so that the motor is not in operation, and STP flashes (STP → STP). To manually stop the pump: <ul style="list-style-type: none"> <li>• Example A: <ul style="list-style-type: none"> <li>– HCS, MES, MSY control modes with initial required value (head) of 4.20 bar and minimum value 0.5 bar: 4.20 BAR →  press → STP once.</li> </ul> </li> <li>• Example B: <ul style="list-style-type: none"> <li>– ACT control mode with initial required value (speed) of 200 10xRPM and minimum value 80 10xRPM: 200 10xRPM →  press → STP once.</li> </ul> </li> </ul>

Display	Mode	Description
ON	ON	<p>Pump on; the motor starts following the selected control mode.</p> <p>It appears for a few seconds when contacts 11 and 12 (see Par. 5.4) are short circuited and the pump is not in STOP mode.</p> <p>To manually set the pump to ON mode:</p> <ul style="list-style-type: none"> <li>• Example A: <ul style="list-style-type: none"> <li>– HCS, MES, MSY control modes that reach a required value (head) of 4.20 bar, starting with a minimum value of 0.5 bar after manual stop: STP →  press → ON → once after a few seconds... → 4.20 BAR.</li> </ul> </li> <li>• Example B: <ul style="list-style-type: none"> <li>– ACT control mode that reaches a requested value (speed) of 200 10xRPM, starting with a minimum value of 80 10xRPM after manual stop: STP →  press → ON → once, and after a few seconds... → 200 10xRPM.</li> </ul> </li> </ul> <p>With the pump in operation, it is possible to display the Actual Head and the Actual Speed:</p> <ul style="list-style-type: none"> <li>• Example A: <ul style="list-style-type: none"> <li>– HCS, MES, MSY control modes with Actual Head 4.20 bar and corresponding Actual Speed of 352 10xRPM: 4.20 BAR →  +  → 352 10XRPM → after 10 seconds or  +  → 4.20 BAR.</li> </ul> </li> <li>• Example B: <ul style="list-style-type: none"> <li>– ACT control mode with Actual Speed 200 10xRPM and corresponding Actual Head of 2.37 bar: 200 10xRPM →  +  → 2.37 BAR → after 10 seconds or  +  → 200 10xRPM.</li> </ul> </li> </ul>

### 6.5.2 Parameters menu visualization

The parameter menu gives the possibility to:

- select all the parameters (see Par. 6.5)
- access Parameter View / Editing (see Par. 6.2).



Parameter	Description
Power on	If after switching ON, parameter Menu View is accessed with P23 = ON, P20 flashes: P20 → P20. Enter the password to display and change the parameters.
Password timeout	If with P23 = ON no button is pressed for over 10 minutes from the last parameter Menu View, both the view and the editing of the parameters are disabled. Enter the password again to display and change the parameters.
Parameters Menu	With P23 = OFF, or after entering the password (P20), it is possible to both display and edit the parameters. When accessing the Parameter Menu, the display shows: P01 → P01 P02 → P02 ... P69 → P69 The flashing parameter, indicating the selection possibility.
Parameters Editing/Visualization	The value of a parameter may be changed using the buttons, or the Modbus and BACnet communication protocols. When returning to the Parameter Menu, the displayed parameter index is increased automatically. For further information see Par. 6.5. • Example A (P20) from 000 to 066: P20 → P20 →  → 000 → 000 →  ... until ... → 066 → 066 →  sets the desired value → P21 → P21 • Example 2 (P26) from 360 to 300: P26 → P26 →  → 360 → 360 →  ... until... → 300 → 300 →  sets the desired value → → P26 → P26.

### 6.5.3 Alarms and errors visualization



Parameter	Description
Alarm	In case of alarm, the corresponding code appears on the display in alternation to the Main View. For example: A01 → 3.56 (ex. BAR) A02 → 285 (ex. 10xRPM) ...
Error	In case of error, the corresponding identification code appears on the display. For example: E01 E02 ...

















## 6.6 Software parameters

Mark	Parameter type
No mark	Applicable to all units.
	Global parameter, shared by all pumps in the same multi-pump system
	Read only

### 6.6.1 Status parameters

Parameter number	Parameter name	Unit of measurement	Description
P01	Required value 	bar/psi/ rpmx10	<p>This parameter shows the SOURCE and the VALUE of the active required value.</p> <p>Visualization cycles between SOURCE and VALUE occur every 3 seconds.</p> <p>SOURCES:</p> <ul style="list-style-type: none"> <li>• SP (SP): internal required value Setpoint related to the control mode selected.</li> <li>• VL (UL): external required value speed Setpoint related to 0-10V input.</li> </ul> <p>VALUE can represent a Speed or a Head, depending on the selected control mode: in case of Head, the unit of measure is defined by parameter P41.</p>
P02	Effective Required Value 	bar/psi	<p>Active required value calculated based on parameters P58 and P59.</p> <p>This parameter is effective only in control modes MSE or MSY.</p> <p>For further information on the calculation of P02, see Par. 6.6.3.</p>

Parameter number	Parameter name	Unit of measurement	Description
P03	Regulation Restart Value [0-100] 	%	It defines the start value after the stop of the pump, as a percentage of the P01 value. If the required value is met and there is no further consumption, then the pump stops. The pump starts again when the pressure drops below P03.  P03 is valid when: <ul style="list-style-type: none"> <li>• Different from 100% (100%=off)</li> <li>• The control mode is HCS, MSE or MSY.</li> </ul> Default: 100%.
P04	Auto-start [OFF-ON] 		If P04 = ON, then the pump starts automatically following a power supply disconnection.  If the pump is switched on after setting P04 = OFF (see Par. 6.5.1), it is stopped so that the motor is not in operation, and STP flashes (STP → STP).  Default: ON.
P05	Operating time months 		Total months of connection to the electric mains, to add to P06.
P06	Operating time hours 	h	Total hours of connection to the electric mains, to add to P05.
P07	Motor Time Months 		This parameter shows the total operating time months, to be added to P08.
P08	Motor time hours 	h	This parameter shows the total operating time hours, to be added to P07.

Parameter number	Parameter name	Unit of measurement	Description
P09	1st error 		This parameter stores the last error occurred in chronological order. The information displayed switches through the values: <ul style="list-style-type: none"> <li>• (Exx): xx indicates the error code</li> <li>• (Hyy): yy is the value of hours referred to P05-P06 when the error Exx happened</li> <li>• (Dww): ww is the value of days referred to P05-P06 when the error Exx happened</li> <li>• (Uzz): zz is the value of weeks referred to P05-P06 when the error Exx happened</li> </ul> Example of visualisation: E04 → K10 → d03 → U15
P10	2nd error 		Saves the penultimate error in chronological order. Other characteristics: like P09.
P11	3rd error 		Saves the third from the last error in chronological order. Other characteristics: like P09.
P12	4th error 		Saves the fourth from the last error in chronological order. Other characteristics: like P09.
P13	Power Module Temperature 	°F (°C)	Temperature of the power module.
P14	Inverter Current 	A	This parameter shows the actual current supplied by the frequency converter.
P15	Inverter Voltage 	V	This parameter shows the actual estimated input voltage of the frequency converter.
P16	Motor Speed 	rpmx10	This parameter shows the actual motor rotational speed.









Parameter number	Parameter name	Unit of measurement	Description
P17	Software version 		This parameter shows the Control Board software version.

### 6.6.2 Settings parameters

Parameter number	Parameter name	Description
P20	Password entering [0-999]	The user can enter here the system password, which gives access to all system parameters: this value is compared with the one stored in P22. When a correct password is entered, the system remains unlocked for 10 minutes.
P21	Jog mode [MIN-MAX]	It deactivates the internal controller of the unit and forces the actual Control Mode (ACT): the motor starts and the value of P21 becomes the temporary ACT setpoint. It can be changed by just entering a new value on P21 without confirming it; otherwise, it causes immediate exit from temporary control.
P22	System password [1-999]	This is the system password, and must be the same as the password entered in P20. Default: 66.
P23	Lock Function [OFF, ON]	By using this function, the user can lock or unlock parameter setting in the main menu. When ON, enter the P20 password to change the parameters. Default: ON.

## 6.6.3 Drive configuration parameters



Parameter number	Parameter name	Unit of measurement	Description
P25	Control mode [ACT, HCS, MSE, MSY]		<p>This parameter sets the Control Mode (default value: HCS)</p> <p><b>ACT:</b> Actuator mode.</p> <ul style="list-style-type: none"> <li>• A single pump maintains a fixed speed at any flow rate. ACT will always try to minimize the difference between the speed setpoint and the actual rotational speed of the motor.</li> <li>• If a 0-10V signal is supplied to terminals 7 and 8, the pump automatically switches to ACT mode, following the external signal, as shown in figure 17.</li> <li>• If the external signal is missing, the pump remains in ACT mode, using the value set as setpoint using the display.</li> </ul> <p><b>HCS:</b> Hydrovar® Controller mode for Single pump.</p> <ul style="list-style-type: none"> <li>• The pump maintains a constant pressure at any flow rate: the Hydrovar® algorithm, based on the set of parameters from P26 to P37 (see Par. 6.5.3), is implemented.</li> <li>• HCS mode must be set in conjunction with the use of an absolute reading pressure sensor installed in the hydraulic circuit, which supplies the pressure feedback signal: HCS will always try to minimize the difference between the pressure setpoint and the pressure feedback signal.</li> </ul> <p><b>MSE:</b> Hydrovar® Controller mode for multiple pumps in Serial Cascade.</p> <ul style="list-style-type: none"> <li>• Pumps are managed in series: only the last activated pump modulates the speed to maintain the set pressure, while all the others in operation rotate at the maximum speed.</li> <li>• The set of pumps, connected to each other through the multi-pump protocol, maintains a constant pressure at any flow rate: the Hydrovar® algorithm, based on the set of parameters from P26 to P37 (see Par. 6.5.3), is implemented.</li> <li>• MSE mode must be set in conjunction with the use of absolute reading pressure sensors, one for each pump, which supply to the set the pressure feedback signal: MSE will always try to minimize the difference between the pressure setpoint and the pressure feedback signal.</li> <li>• Using the multi-pump protocol, it is possible to connect up to 3 pumps, all of the same type and with the same power.</li> </ul> <p><b>MSY:</b> Hydrovar® Controller mode for Multiple pumps in Synchronous Cascade.</p> <ul style="list-style-type: none"> <li>• The pumps are synchronised: they all keep the set pressure and operate at the same speed.</li> <li>• Other characteristics: as for MSE mode.</li> </ul>

Parameter number	Parameter name	Unit of measurement	Description
P26	Max RPM set [ACT set-Max*] 	rpmx10	Maximum pump speed setup.
P27	Min RPM set [Min*-ACT set] 	rpmx10	Minimum pump speed setup.
P28	Ramp 1 [1-250] 	s	This parameter adjusts the fast acceleration time. It affects the control of the pump for HCS, MSE and MSY control modes (also see Par. 6.6.2). Default: 3 s.
P29	Ramp 2 [1-250] 	s	This parameter adjusts the fast deceleration time. It affects the control of the pump for HCS, MSE and MSY control modes (also see Par. 6.6.2). Default: 3 s.
P30	Ramp 3 [1-999] 	s	This parameter adjusts the slow acceleration. It determines: <ul style="list-style-type: none"> <li>• The Hydrovar® adjustment speed, in case of small flow rate variations</li> <li>• The constant outgoing pressure.</li> </ul> The ramp depends on the system being controlled, and affects the control of the pump in HCS, MSE and MSY modes (also see Par. 6.6.2). Default: 35 s.
P31	Ramp 4 [1-999] 	s	Adjustment of the slow deceleration time (also see Par. 6.6.2). Other characteristics: as for Ramp 3.
P32	Ramp Speed Min Acceleration [2.0-25.0] 	s	This parameter sets the fast acceleration time. It represents the acceleration ramp used by the Hydrovar® controller until the minimum speed of the pump is reached (P27). It affects the control of the pump for HCS, MSE and MSY control modes (also see Par. 6.6.2). Default: 2.0 s.
P33	Ramp Speed Min Deceleration [2.0-25.0] 	s	This parameter sets the fast deceleration time. It represents the deceleration ramp used by the Hydrovar® controller for stopping the pump once the minimum speed of the pump is reached (P27). It affects the control of the pump for HCS, MSE and MSY control modes (also see Par. 6.6.2). Default: 2.0 s.





Parameter number	Parameter name	Unit of measurement	Description
P34	Speed Min Configuration [STP, SMI] <b>G</b>		<p>This parameter defines the operation of the Hydrovar® controller once the minimum speed of the pump is reached (P27):</p> <ul style="list-style-type: none"> <li>• STP (STP): once the required pressure is reached and no further request is made, the pump speed decreases to the selected P27 value: Hydrovar® then keeps running for the selected time interval (P35), and then stops automatically.</li> <li>• SNI (SMI): once the required pressure is reached and no further request is made, the pump speed decreases to the selected P27 value: Hydrovar® continues running at the same speed. This parameter affects the control of the pump for HCS, MSE and MSY control modes.</li> </ul> <p>Default: STP</p>
P35	Smin time [0-100] <b>G</b>	s	<p>This parameter sets the time delay before a shut-off below P27 occurs.</p> <p>It is only used by the Hydrovar® controller if P34 = STP.</p> <p>It affects the control of the pump for HCS, MSE and MSY control modes.</p> <p>Default: 0 s.</p>
P36	Window [0-100] <b>G</b>	%	<p>This parameter sets the ramp control interval, as a percentage of the pressure setpoint.</p> <p>It is used to define the range of pressures, around the setpoint, in which the Hydrovar® controller uses slow acceleration and deceleration ramps instead of fast ones.</p> <p>It affects the control of the pump for HCS, MSE and MSY control modes (also see Par. 6.6.2).</p> <p>Default: 10%.</p>
P37	Hysteresis [0-100] <b>G</b>	%	<p>This parameter sets the slow ramp hysteresis, as a percentage of P36.</p> <p>It helps define the pressure range, around the setpoint, in which Hydrovar® goes from slow acceleration ramp (P28) to slow deceleration ramp (P29).</p> <p>The parameter affects the control of the pump for HCS, MSE and MSY control modes (also see Par. 6.6.2).</p> <p>Default: 80%.</p>
P38	Speed Lift [0-MAX*] <b>G</b>	rpmx10	<p>This parameter sets the speed limit after which the linear increase of the actual require value starts (P02), until the total increase (P39) at maximum speed (P26).</p> <p>Default: P27.</p>

Parameter number	Parameter name	Unit of measurement	Description
P39	Lift Amount [0-200] 	%	This parameter sets the increase value of the actual required value (P02) at the maximum speed (P26), measured as a percentage of the required value (P01). It determines the increase of the required pressure set, useful to compensate for flow resistances at high flow rates. Default: 0.

#### 6.6.4 Sensor configuration parameters

Parameter number	Parameter name	Unit of measurement	Description
P41	Pressure Sensor Unit Of Measure [BAR, PSI] 		This parameter sets the unit of measure (BAR, PSI) for the pressure sensor. It affect the head view LED parameter (see Par. 6.3.4). Default: bar.
P42	Full scale value for pressure Sensor 1 4-20mA [0.0-25.0BAR] / [0.0-363PSI] 	bar/psi	This parameter sets the Full Scale value of the 4-20mA pressure sensor connected to analog input 17 and 18. Default: depending on the type of pump.



Parameter number	Parameter name	Unit of measurement	Description
P44	Zero Pressure Auto-Calibration	bar/psi	<p>This parameter lets the user perform the initial auto-calibration of the pressure sensor.</p> <p>It is used to compensate for the offset signal of the sensor at zero pressure caused by the tolerance of the sensor itself.</p> <p>Procedure:</p> <ol style="list-style-type: none"> <li>1. Access P44 when the hydraulic system is at 0 pressure (no water inside), or with the pressure sensor disconnected from the piping: the actual value of 0 pressure is displayed.</li> <li>2. Start the auto-calibration by pressing   or (see Par. 6.2).</li> <li>3. At the end of the auto-calibration, the 0 (zero) pressure is displayed, or the “---“ (---) message, if the sensor signal is out of the permitted tolerance.</li> </ol>
P45	Pressure Minimum Threshold [0-42] 	bar/psi	<p>Setting the minimum pressure threshold.</p> <p>If the system pressure falls below this threshold for the time set in P46, a low pressure error E14 is generated.</p> <p>Default: 0 bar.</p>
P46	Pressure Minimum Threshold - Delay Time [1-100] 	s	<p>Time delay setup.</p> <p>This parameter sets the time delay during which the unit remains idle with a system pressure below P45, before generating the low pressure error E14.</p> <p>Default: 2 s.</p>
P47	Pressure Minimum Threshold – Automatic Error Reset [OFF, ON] 		<p>Enabling/disabling of automatic unit attempts in case of low pressure error.</p> <p>Default: ON.</p>

Parameter number	Parameter name	Unit of measurement	Description
P48	Lack Of Water Switch Input [DIS, ALR, ERR]		<p>This parameter enables/disables the management of the lack of water input (see Par. 4.3.3, terminals 13 and 14).</p> <p>It defines the behaviour of the unit when the lack of water input is enabled and the switch is open:</p> <ul style="list-style-type: none"> <li>• DIS (DIS): the unit doesn't manage the information coming from the "lack of water" input.</li> <li>• ALr (ALr): the unit reads the "lack of water" Input (enabled) and reacts, at the opening of the switch, by displaying the corresponding alarm A06 on the display, and keeping the motor running.</li> <li>• Err (Err): Err, the unit reads the Lack Of Water Input (enabled) and reacts, at the opening of the switch, by stopping the motor and generating the corresponding error E11. The error condition is removed when the switch closes again and the motor is started.</li> </ul> <p>Default: ERR.</p>

### 6.6.5 RS485 Interface parameters

Parameter name	Parameter number	Unit of measurement	Description
P50	Communication protocol [MOD, BAC]		<p>This parameter selects the specific protocol on the communication port:</p> <ul style="list-style-type: none"> <li>• NOD (MOD): Modbus RTU</li> <li>• BAC (BAC): BACnet MS/TP.</li> </ul> <p>Default: MOD.</p>



Parameter name	Parameter number	Unit of measurement	Description
P51	Communication protocol - Address [1-247]/[0-127]		This parameter sets the desired address for the unit, when connected to an external device, depending on the protocol selected in P50: <ul style="list-style-type: none"> <li>• MOD: any value in the 1-247 range</li> <li>• BAC: any value in the 0-127 range.</li> </ul>
P52	Comm Protocol – BAUDRATE [4.8, 9.6, 14.4, 19.2, 38.4, 56.0, 57.6 KBPS]	kbps	This parameter sets the desired baud rate for the communication port. Default: 9.6 kbps.
P53	BACnet Device ID Offset [0-999]		This parameter sets the hundreds, tens and units of the BACnet Device ID. Default: 002. Device ID default: 84002.
P54	Comm Protocol – Configuration [8N1, 8N2, 8E1, 8o1]		This parameter sets the length of the data bits, the parity and the length of the STOP bits.

### 6.6.6 Multi-pump configuration parameters

All these parameters affect MSE and MSY control modes.



Parameter number	Parameter name	Unit of measurement	Description
P55	Multipump – Address [1-3]		This parameter sets the address of each pump based on the following criteria: <ul style="list-style-type: none"> <li>• Each pump needs an individual pump address (1-3)</li> <li>• Each address may only be used once.</li> </ul> Default: 1.
P56	Multipump – Max Units [1-3] 		This parameter sets the maximum number of pumps operating at the same time. Default: 3.

P57	Multipump – Switch Interval [0-250]  G	h	Setpoint of the main pump forced switch interval.  If the pump with priority 1 works in continuous mode until this time is reached, the switch between this pump and the next is forced. On the other hand, if the system stops completely due to the setpoint being reached, the next start priority 1 will be assigned in a way to ensure an even distribution of the operating hours of all pumps.  Default: 24 h.
P58	Multipump – Actual Value Increase [0.0-25.0BAR] / [0.0-363PSI]  G	bar/psi	This parameter affects the calculation of P02, to improve the Multipump control as described in paragraph 6.6.3.  Default: 0.35 bar.
P59	Multipump – Actual Value Decrease [0.0-25.0BAR] / [0.0-363PSI]  G	bar/psi	This parameter affects the calculation of P02, to improve the multi-pump control as described in paragraph 6.6.3.  Default: 0.15 bar.
P60	Multipump – Enable Speed [P27-P26]  G	rpmx10	This parameter sets the speed that a pump must reach before starting the next assist pump, after a system pressure drop below the difference between P02 and P59.  Default: depending on the type of pump.
P61	Multipump Synchronous – Speed Limit [P27-P26]  G	rpmx10	This parameter sets the speed limit below which the first assist pump stops.  Default: depending on the type of pump.
P62	Multipump Synchronous – Window [0-100]  G	rpmx10	This parameter sets the speed limit for the stop of the next assist pump.  Default: 150 rpmx10.

P63	Multipump – Priority 		This parameter shows the pump priority value within the multi-pump set. This parameter displays the following information: Pr1 (Pr1) .. Pr3 (Pr3) or Pr0 (Pr0) where: <ul style="list-style-type: none"> <li>• Pr1 .. PR3, indicate that the pump is communicating with other pumps of the displayed priority order.</li> <li>• Pr0 indicates that the pump does not detect the communication with other pumps and is considered alone in the multi-pump bus</li> </ul>
P64	Multipump – Revision 		This parameter shows the multi-pump protocol revision value used.

### 6.6.7 Test run configuration

Test Run is a function that starts the pump after the last stop, in order to prevent it from blocking.

Parameter number	Parameter name	Unit of measurement	Description
P65	Test Run – Time Start [0-100] 	h	This parameter sets the time after which, once the pump has stopped for the last time, the Test Run will start. Default: 100 h.
P66	Test Run – Speed [Min-Max] 	rpmx10	This parameter sets the pump rotational speed for the Test Run. The Min and Max speeds depend on the pump type. Default: 200 rpmx10.
P67	Test Run – Time Duration[0-180] 	s	This parameter sets the duration of the Test Run. Default: 10 s.

### 6.6.8 Special parameters

Parameter number	Parameter name	Unit of measurement	Description
P68	Default Values Reload [NO, rES]		If set to RES, after confirmation this parameter performs a factory reset that reloads the default parameter values.

---

Parameter number	Parameter name	Unit of measurement	Description
P69	Avoid Frequent Parameters Saving [NO, YES]		<p>This parameter limits the frequency with which the unit stores the required value P02 in the EEPROM memory, in order to extend its life.</p> <p>This could be particularly useful in applications with BMS control devices that require continuous variation of the value for fine tuning purposes.</p> <p>Default: NO.</p>

---

# 7 Maintenance

## 7.1 Precautions



---

**Electrical Hazard:**

- Before attempting to use the unit, check that it is unplugged and that the pump and the control panel cannot restart, even unintentionally. This also applies to the auxiliary control circuit of the pump.
- Before any interventions on the unit, the network power supply and any other input voltages must be disconnected for the minimum time indicated in Table 9 (the capacitors of the intermediate circuit must be discharged by the built-in discharge resistors).

- 
1. Make sure that the cooling fan and the vents are free from dust.
  2. Make sure that the ambient temperature is correct according to the limits of the unit.
  3. Make sure that qualified personal perform all modifications of the unit.
  4. Make sure that the unit is disconnected from the power supply before any work is carried out. Always consider the pump and motor Instruction.

**Function and parameter control**

In case of changes to the hydraulic system:

1. Make sure that all functions and parameters are correct
2. Adjust the functions and parameters if necessary.

# 8 Troubleshooting

## Operation troubleshooting

In case of alarm or error, the display shows an ID code and the STATUS LED turns on (also see Par. 6.3.2).

In case of several alarms and/or errors, the display shows the main one.

Alarms and errors:

- are saved with date and time
- can be reset by switching the unit off for at least 1 minute.

Errors cause the triggering of the status relay on the following terminal box pins:

- single-phase version: pins 4 and 5
- three-phase version: pins 24 and 25

## 8.1 Alarm codes

Table 10: Alarm codes

code	Description	Cause	Remedy
A03	Derating	Temperature too high	<ul style="list-style-type: none"> <li>• Lower the room temperature</li> <li>• Lower the water temperature</li> <li>• Lower the load</li> </ul>
A05	Data memory alarm	Data memory corrupted	<ol style="list-style-type: none"> <li>1. Reset the default parameters using parameter P68</li> <li>2. Wait 10 s</li> <li>3. Restart the pump</li> </ol> <p>If the problem continues, contact Xylem or the Authorised Distributor</p>
A06	LOW alarm	Lack of water detection (if P48= ALR)	Check the water level inside the tank
A15	EEPROM write failure	Data memory damaged	Stop the pump for 5 minutes and then restart it again; if the problem continues, contact Xylem or the Authorised Distributor
A20	Internal alarm		Stop the pump for 5 minutes and then restart it again; if the problem continues, contact Xylem or the Authorised Distributor
A30	Multi-pump connection alarm	Corrupted multi-pump connection	<ul style="list-style-type: none"> <li>• Check the condition of the connection cables</li> <li>• Check that there are no address discrepancies</li> </ul>
A31	Loss of multi-pump connection	Loss of multi-pump connection	Check the condition of the connection cables



## 8.2 Error codes

code	Description	Cause	Remedy
E01	Internal communication error	Internal communication lost	Stop the pump for 5 minutes and then restart it again; if the problem continues, contact Xylem or the Authorised Distributor
E02	Motor overload error	<ul style="list-style-type: none"> <li>High motor current</li> <li>Current absorbed by the motor too high</li> </ul>	Stop the pump for 5 minutes and then restart it again; if the problem continues, contact Xylem or the Authorised Distributor
E03	DC-bus overvoltage error	<ul style="list-style-type: none"> <li>DC-bus overvoltage</li> <li>External conditions cause the operation of the pump from generator</li> </ul>	Check: <ul style="list-style-type: none"> <li>the system configuration</li> <li>the position and integrity of the non-return valves</li> </ul>
E04	Rotor blocked	<ul style="list-style-type: none"> <li>Motor stall</li> <li>Loss of rotor synchronism or rotor blocked by external materials</li> </ul>	<ul style="list-style-type: none"> <li>Check that there are no foreign bodies preventing the pump from turning</li> <li>Stop the pump for 5 minutes and then start it again</li> </ul> If the problem continues, contact Xylem or the Authorised Distributor
E05	EEPROM Data memory error	EEPROM Data memory corrupted	Stop the pump for 5 minutes and then restart it again; if the problem continues, contact Xylem or the Authorised Distributor
E06	Grid voltage error	Voltage supply out of operating range	Check: <ul style="list-style-type: none"> <li>the voltage</li> <li>the connection of the electric system</li> </ul>
E07	Motor winding temperature error	Motor thermal protection trip	<ul style="list-style-type: none"> <li>Check for impurities near the impeller and rotor. Remove them if necessary</li> <li>Check the conditions of installation and the water and air temperature</li> <li>Wait for the motor to cool down</li> <li>If the error persists, stop the pump for 5 minutes and then start it again</li> </ul> If the problem continues, contact Xylem or the Authorised Distributor

code	Description	Cause	Remedy
E08	Power module temperature error	Frequency converter thermal protection trip	Check the conditions of installation, and the air temperature
E09	Generic hardware error	Hardware error	Stop the pump for 5 minutes and then restart it again; if the problem continues, contact Xylem or the Authorised Distributor
E11	LOW error	Lack of water detection (if P48= ERR)	Check the water level inside the tank
E12	Pressure sensor error	Missing pressure sensor (not present in ACT mode)	Check the condition of the sensor connection cables
E14	Low pressure error	Pressure below minimum threshold (not present in ACT mode)	Check the settings of parameters P45 and P46
E15	Loss of phase error	One of the three power supply phases is missing (three-phase versions only)	Check the connection to the power supply network
E30	Multi-pump protocol error	Incompatible multi-pump protocol	Bring all the units to the same firmware version

See also Par. 6.3.2 and Par. 6.4.3.

# 9 Technical Specification

## 9.1 Electrical and environmental specifications

	e-SM Drive model										
	103	105	107	111	115	303	305	307	311	315	322
<b>Input</b>											
Input frequency [Hz]	50/60 ± 2										
Main supply	L1 L2					L1 L2 L3					
Nominal input voltage [V]	208-240 ±10%					208-240 / 380-460 ±10%					380-460 ±10%
Maximum current absorbed (AC) in continuous service (S1) [A]	See data plate										
PDS Efficiency Class	IES2										
<b>Output</b>											
Min.-Max. Speed [rpm]	1200 - 3600										
Leakage Current [mA]	< 3,5										
I/O auxiliar + 15VDC power supply [mA]	I <sub>max</sub> < 40										
Fault signal relay	1 x NO V <sub>max</sub> < 250 [VAC] , I <sub>max</sub> < 2 [A]					1 x NO V <sub>max</sub> < 250 [VAC] , I <sub>max</sub> < 2 [A]					
Motor status relay	-					1 x NO V <sub>max</sub> < 250 [VAC] , I <sub>max</sub> < 2 [A]					
EMC (Electro Magnetic Compatibility )	See Par. Declarations. Installations must be performed in accordance with the EMC good practice guidelines (e.g. avoid "eyebolts" on the transmission side)										
Sound pressure LpA [dB(A)] @ [rpm]	< 62 @3000 < 66 @3600										
Insulation class	155 F										
Protection class	IP 55, Enclosure NEMA Type 3R										

	e-SM Drive model										
	103	105	107	111	115	303	305	307	311	315	322
Relative humidity (storage & operating)	5%-95% UR										
Storage temperature [°F] / [°C]	-13-149 / -25-65										
Operating temperature [°F] / [°C]	-4-122 / -20-50										
Air Pollution	Pollution Degree 2										
Installation altitude a.s.l. [ft] / [m]	< 3280 / 1000 Derating may occur at higher altitudes										

## 9.2 Dimensions and weights

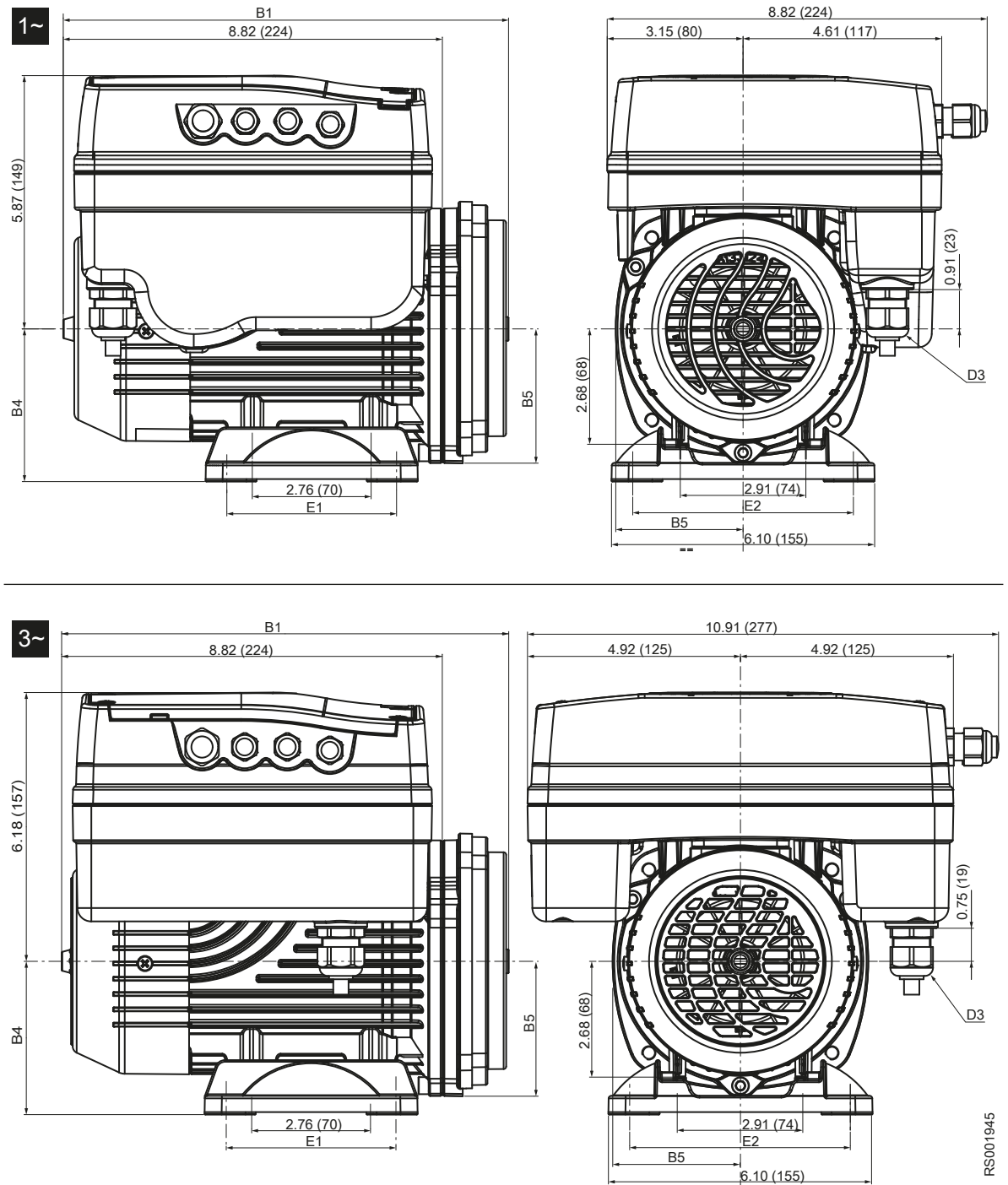

Figure 9: Dimensions [in. (mm)]

Table 11: Dimensions and weights

Model	Net weight (motor + drive) [lb (kg)]					B1	B4	B5	D3	E1	E2
	1~	111	303	311	322						
	103	115	305	315							
	105		307								
	107										
ESM80... HMHA	16.53 (7.5)	19.84 (9)	28.66 (13)	31.97 (14.5)	35.27 (16)	10.35 (263)	3.54 (90)	3.11 (79)	M20	3.94 (100)	4.92 (125)

ESM80... HMHB	16.76 (7.6)	202.3 (9.2)	29.10 (13.2)	32.19 (14.6)	35.49 (16.1)	10.55 (268)	3.54 (90)	3.15 (80)		3.94 (100)	4.92 (125)
ESM80... HMHC	17.42 (7.9)	20.72 (9.4)	29.54 (13.4)	32.63 (14.8)	36.16 (16.4)	10.71 (272)	3.54 (90)	3.58 (91)		3.94 (100)	4.92 (125)
ESM90R. ..56C	15.87 (7.2)	19.40 (8.8)	27.78 (12.6)	31.53 (14.3)	34.83 (15.8)	11.57 (294)	—	3.27 (83)	NPT 1/2"	—	—
... = 103, 105, 107, 111, 115, 303, 305, 307, 311, 315, 322 - = motor foot is not included.											

# 10 Cybersecurity

## Xylem Product Cybersecurity

Xylem values your system security and the availability of your critical services. For more information on Xylem cybersecurity practices or to contact the cybersecurity team please visit [xylem.com/security](https://xylem.com/security).

# Xylem |'zīləm|

- 1) The tissue in plants that brings water upward from the roots;
- 2) a leading global water technology company.

We're a global team unified in a common purpose: creating advanced technology solutions to the world's water challenges. Developing new technologies that will improve the way water is used, conserved, and re-used in the future is central to our work. Our products and services move, treat, analyze, monitor and return water to the environment, in public utility, industrial, residential and commercial building services settings. Xylem also provides a leading portfolio of smart metering, network technologies and advanced analytics solutions for water, electric and gas utilities. In more than 150 countries, we have strong, long-standing relationships with customers who know us for our powerful combination of leading product brands and applications expertise with a strong focus on developing comprehensive, sustainable solutions.

**For more information on how Xylem can help you, go to [www.xylem.com](http://www.xylem.com)**



Xylem Inc.  
1 Goulds Drive  
Auburn - NY 13021  
USA  
Tel: +1 (866) 325-4210  
Fax: +1 (800) 322-5877  
[www.xylem.com/goulds](http://www.xylem.com/goulds)

Visit our Web site for the latest version of this document and more information

The original instruction is in English. All non-English instructions are translations of the original instruction.

© 2021 Xylem Inc

Goulds is a registered trademark of Goulds Pumps, Inc. and is used under license.