

BALDOR® • RELIANCE 

Product Information Packet

EL11203

.25HP, 1725RPM, 1PH, 60HZ, 48, 3411LC, OPEN, F1

Part Detail							
Revision:	G	Status:	PRD/A	Change #:		Proprietary:	No
Type:	AC	Elec. Spec:	34WGR064	CD Diagram:	CD0055	Mfg Plant:	
Mech. Spec:	34F351	Layout:	34LYF351	Poles:	04	Created Date:	02-21-2014
Base:	RG	Eff. Date:	02-27-2018	Leads:	6#18		

Specs			
Catalog Number:	EL11203	Insulation Class:	F
Enclosure:	OPEN	Inverter Code:	Not Inverter
Frame:	48	KVA Code:	L
Frame Material:	Steel	Lifting Lugs:	No Lifting Lugs
Output @ Frequency:	.250 HP @ 60 HZ	Locked Bearing Indicator:	No Locked Bearing
Synchronous Speed @ Frequency:	1800 RPM @ 60 HZ	Motor Lead Quantity/Wire Size:	6 @ 18 AWG
Voltage @ Frequency:	230.0 V @ 60 HZ	Motor Lead Exit:	Ko Box
	115.0 V @ 60 HZ	Motor Lead Termination:	Flying Leads
XP Class and Group:	None	Motor Type:	3411LC
XP Division:	Not Applicable	Mounting Arrangement:	F1
Agency Approvals:	CSA	Power Factor:	89
	UR	Product Family:	General Purpose
Auxillary Box:	No Auxillary Box	Pulley End Bearing Type:	Ball
Auxillary Box Lead Termination:	None	Pulley Face Code:	Standard
Base Indicator:	Rigid	Pulley Shaft Indicator:	Standard
Bearing Grease Type:	Polyrex EM (-20F +300F)	Rodent Screen:	None
Blower:	None	RoHS Status:	ROHS COMPLIANT
Current @ Voltage:	1.300 A @ 230.0 V	Shaft Extension Location:	Pulley End

	1.900 A @ 208.0 V	Shaft Ground Indicator:	No Shaft Grounding
	2.600 A @ 115.0 V	Shaft Rotation:	Reversible
Design Code:	-	Shaft Slinger Indicator:	No Slinger
Drip Cover:	No Drip Cover	Speed Code:	Single Speed
Duty Rating:	CONT	Motor Standards:	NEMA
Electrically Isolated Bearing:	Not Electrically Isolated	Starting Method:	Direct on line
Feedback Device:	NO FEEDBACK	Thermal Device - Bearing:	NONE (OLD)
Front Face Code:	Standard	Thermal Device - Winding:	None
Front Shaft Indicator:	None	Vibration Sensor Indicator:	No Vibration Sensor
Heater Indicator:	No Heater	Winding Thermal 1:	None
		Winding Thermal 2:	None

Nameplate NP3155L												
CAT.NO.	EL11203											
SPEC.	34F351R064G1											
HP	.25											
VOLTS	115/230											
AMP	2.6/1.3											
RPM	1725											
FRAME	48					HZ	60			PH	1	
SER.F.	1.35					CODE	L		DES	-	CL	F
F.L. AVG. EFF.	68.5					PF	89					
RATING	40C AMB-CONT											
CC									USABLE AT 208V	1.9		
DE	6203					ODE	6203					
ENCL	OPEN					SN						
	SFA 3.4/1.7											

Parts List		
Part Number	Description	Quantity
SA276898	SA 34F351R064G1	1.000 EA
RA263456	RA 34F351R064G1	1.000 EA
OC3020F12SP	CAPACITORS 20 MFD 370 VAC	1.000 EA
EC1161A02	BMI 091A161B125AD2A ELEC CAP 115V 1.4 X	1.000 EA
NS2512A01	INSULATOR, CONDUIT BOX X	1.000 EA
34CB3002A	CB CAST W/.88 DIA HOLE	1.000 EA
51XB1016A07	10-16 X 7/16 HXWSSLD SERTYB	2.000 EA
11XW1032G06	10-32 X .38, TAPTITE II, HEX WSHR SLTD U	1.000 EA
51XW0832A07	8-32 X .44, TAPTITE II, HEX WSHR SLTD SE	2.000 EA
SP1006A01	TERM. BOARD, MODE 35 SW X H-23655	1.000 EA
34EP3210A01SP	FR ENDPLATE, MACH	1.000 EA
34GS5003A01	FOAM SLEEVE, ID = 2 1/16" X 4 3/8"	2.000 EA
34CB3801	CAPACITOR BOX, DIE CAST	1.000 EA
51XB1214A08	12-14 X 1/2HX WS SL SR TYBX	2.000 EA
HW5100A03	WAVY WASHER (W1543-017)	1.000 EA
34EP3212A02	PU ENDPLATE, MODEL 34 OPEN	1.000 EA
XY1032A02	10-32 HEX NUT DIRECTIONAL SERRATION	4.000 EA
34CB4517	CB LID 4 MTG HOLES .22 DIA STAMPED, FOR	1.000 EA
51XW0832A07	8-32 X .44, TAPTITE II, HEX WSHR SLTD SE	4.000 EA
MG1000Y03	MUNSELL 2.53Y 6.70/ 4.60, GLOSS 20,	0.014 GA
85XU0407S04	4X1/4 U DRIVE PIN STAINLESS	2.000 EA
HA3100A44	THRUBOLT 10-32 X 8.000	4.000 EA
SP5051B17	MDL 34 TORQ STAT SW,TYPE LC, STD F1 & F2	1.000 EA
MN416A01	TAG-INSTAL-MAINT no wire (1200/bx) 5/18	1.000 EA

Parts List (continued)		
Part Number	Description	Quantity
LC0001A01	CONN LABEL / WARNING LABEL (LC0001 / LB1	1.000 EA
NP3155L	ALUM SUPER-E UL CSA CC "SEMS"	1.000 EA
35PA1000	PKG GRP, PRINT PK1008A06	1.000 EA

AC Induction Motor Performance Data

Record # 47364 - Typical performance - not guaranteed values

Winding: 34WGR064-R001	Type: 3411LC	Enclosure: OPEN
-------------------------------	---------------------	------------------------

Nameplate Data				115 V, 60 Hz: Low Voltage Connection	
Rated Output (HP)	.25			Full Load Torque	0.754 LB-FT
Volts	115/230			Start Configuration	direct on line
Full Load Amps	2.6/1.3			Breakdown Torque	1.86 LB-FT
R.P.M.	1725			Pull-up Torque	1.57 LB-FT
Hz	60	Phase	1	Locked-rotor Torque	2.48 LB-FT
NEMA Design Code	-	KVA Code	L	Starting Current	20.3 A
Service Factor (S.F.)	1.35			No-load Current	1.53 A
NEMA Nom. Eff.	68.5	Power Factor	89	Line-line Res. @ 25°C	3.4881 Ω A Ph 6.3165 Ω B Ph
Rating - Duty	40C AMB-CONT			Temp. Rise @ Rated Load	27°C
S.F. Amps	3.7/1.7			Temp. Rise @ S.F. Load	34°C

Load Characteristics 115 V, 60 Hz, 0.25 HP

% of Rated Load	25	50	75	100	125	150	S.F.
Power Factor	67	79	85	90	92	94	93
Efficiency	37.2	55.5	65.1	69.7	71.4	71.1	71.3
Speed	1783.6	1770.8	1755.8	1739.1	1717.7	1691.5	1707
Line amperes	1.63	1.85	2.18	2.59	3.1	3.69	3.34

Performance Graph at 115V, 60Hz, 0.25HP Typical performance - Not guaranteed values

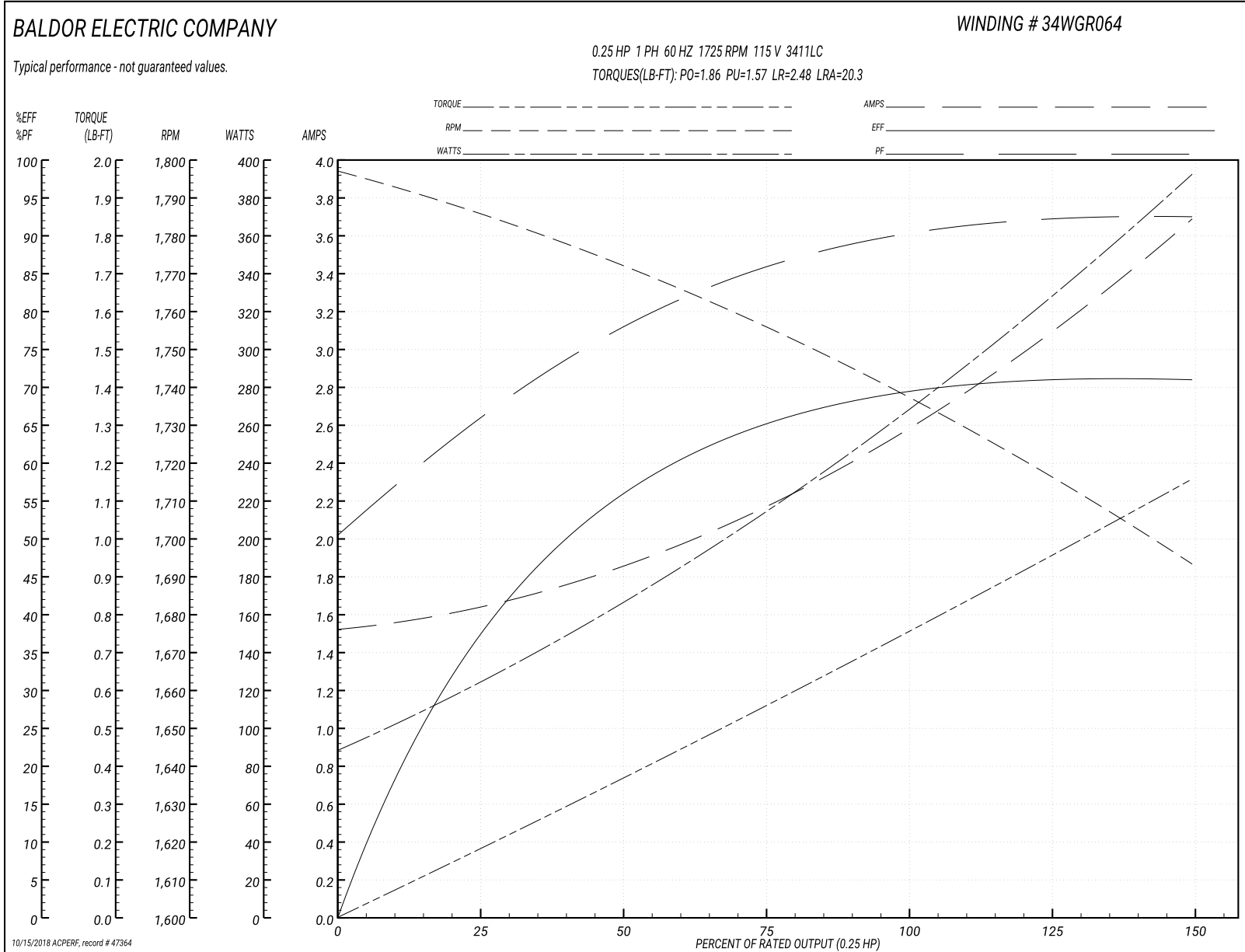

AC Induction Motor Performance Data

Record # 49831 - Typical performance - not guaranteed values

Winding: 34WGR064-R001	Type: 3411LC	Enclosure: OPEN
-------------------------------	---------------------	------------------------

Nameplate Data				230 V, 60 Hz: High Voltage Connection	
Rated Output (HP)	.25			Full Load Torque	0.753 LB-FT
Volts	115/230			Start Configuration	direct on line
Full Load Amps	2.6/1.3			Breakdown Torque	1.88 LB-FT
R.P.M.	1725			Pull-up Torque	1.23 LB-FT
Hz	60	Phase	1	Locked-rotor Torque	1.94 LB-FT
NEMA Design Code	-	KVA Code	L	Starting Current	9.92 A
Service Factor (S.F.)	1.35			No-load Current	0.836 A
NEMA Nom. Eff.	68.5	Power Factor	89	Line-line Res. @ 25°C	3.39 Ω A Ph 6.4 Ω B Ph
Rating - Duty	40C AMB-CONT			Temp. Rise @ Rated Load	30°C
S.F. Amps	3.4/1.7			Temp. Rise @ S.F. Load	36°C
				Rotor inertia	0.0261 LB-FT ²

Load Characteristics 230 V, 60 Hz, 0.25 HP

% of Rated Load	25	50	75	100	125	150	S.F.
Power Factor	67	79	86	90	92	93	92
Efficiency	34.6	52.7	62.8	67.9	69.9	69.7	69.8
Speed	1784	1771	1756	1740	1718	1692	1708
Line amperes	0.871	0.97	1.13	1.33	1.58	1.87	1.7

Performance Graph at 230V, 60Hz, 0.25HP Typical performance - Not guaranteed values

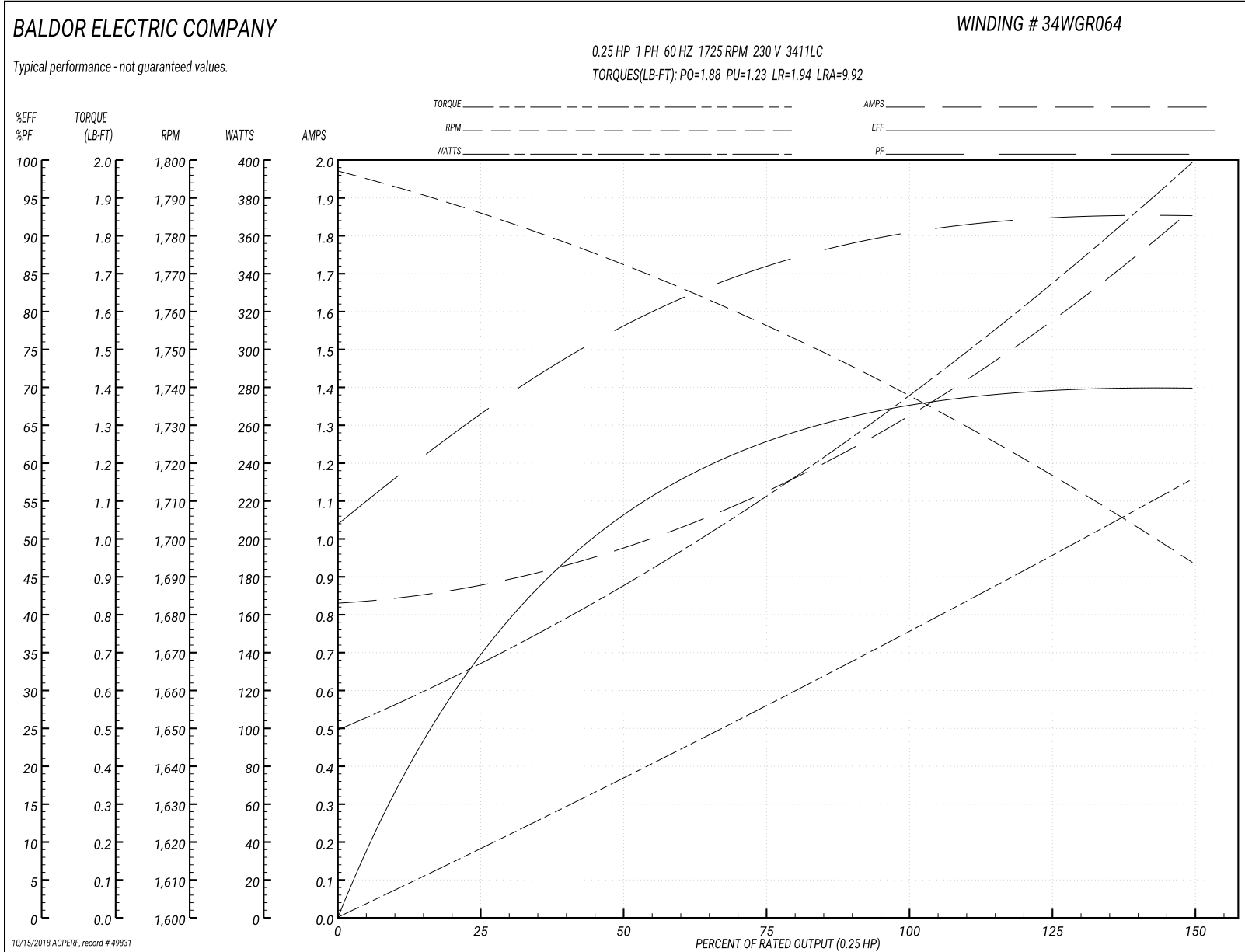

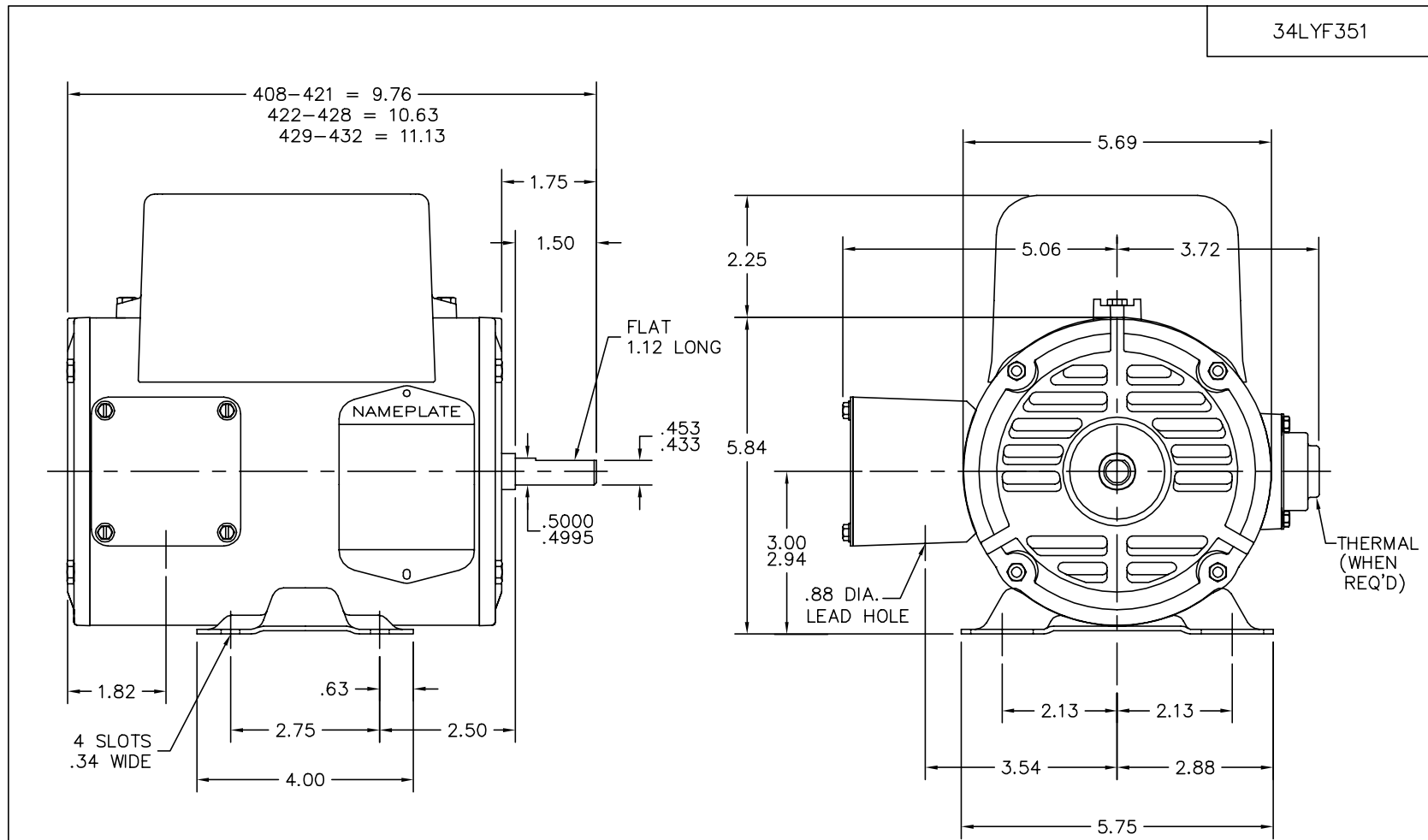

34LYF351

CUSTOMER IS RESPONSIBLE FOR DETERMINING THAT MOTOR PERFORMANCE IS SUITABLE IN THE APPLICATION.

REV. DESC: DIM: KOBX LOC FROM ODE TO THE CENTERLINE OF KOBX		
REV. LTR: C	VERSION: 02	TDR: 000000386903
	FILE: \AAA\00037\242	REVISED: 11:20:24 01/26/2006
	MTL: -	BY: ENMARW1

BALDOR ELECTRIC Co.
STD HOR 34LC NEMA 48 OPEN

34LYF351

CD0055

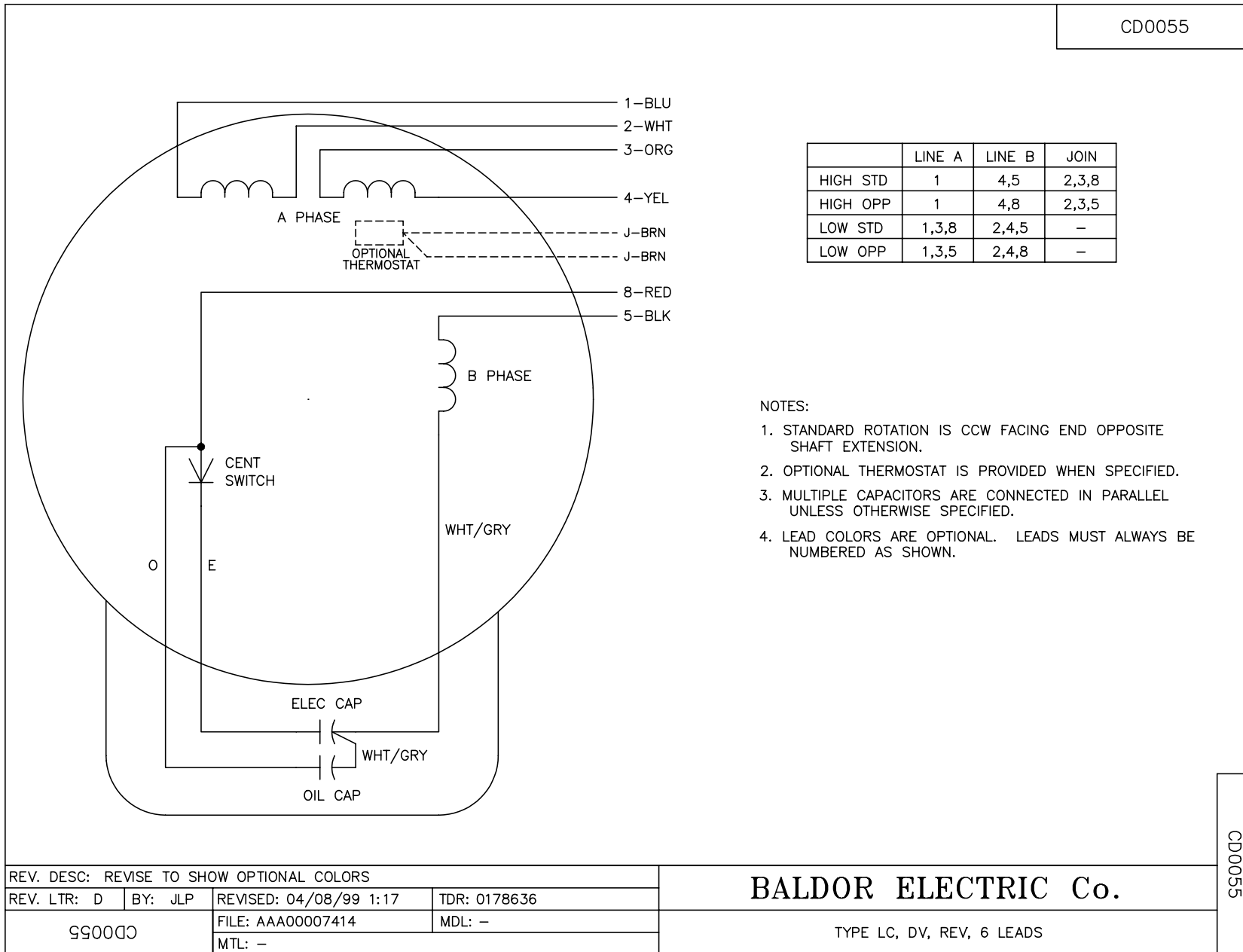

REV. DESC: REVISE TO SHOW OPTIONAL COLORS			
REV. LTR: D	BY: JLP	REVISED: 04/08/99 1:17	TDR: 0178636
990000		FILE: AAA00007414	MDL: -
		MTL: -	

BALDOR ELECTRIC Co.

TYPE LC, DV, REV, 6 LEADS

CD0055