

**BALDOR® • RELIANCE** 

**Product Information Packet**

**EM3615T-BG**

**5HP,1750RPM,3PH,60HZ,184T,3642M,TEFC,F1**

Part Detail							
Revision:	G	Status:	PRD/A	Change #:		Proprietary:	No
Type:	AC	Elec. Spec:	36WGS268	CD Diagram:	CD0005	Mfg Plant:	
Mech. Spec:	36Q126	Layout:	36LYQ126	Poles:	04	Created Date:	10-04-2013
Base:	RG	Eff. Date:	04-19-2017	Leads:	9#16		

Specs			
Catalog Number:	EM3615T-BG	Heater Indicator:	No Heater
Enclosure:	TEFC	Insulation Class:	F
Frame:	184T	Inverter Code:	Inverter Ready
Frame Material:	Steel	KVA Code:	J
Output @ Frequency:	5.000 HP @ 60 HZ	Lifting Lugs:	Standard Lifting Lugs
Synchronous Speed @ Frequency:	1800 RPM @ 60 HZ	Locked Bearing Indicator:	Locked Bearing
Voltage @ Frequency:	460.0 V @ 60 HZ	Motor Lead Quantity/Wire Size:	9 @ 16 AWG
	230.0 V @ 60 HZ	Motor Lead Exit:	Ko Box
XP Class and Group:	None	Motor Lead Termination:	Flying Leads
XP Division:	Not Applicable	Motor Type:	3642M
Agency Approvals:	UR	Mounting Arrangement:	F1
	CSA EEV	Power Factor:	78
	CSA	Product Family:	General Purpose
Auxillary Box:	No Auxillary Box	Pulley End Bearing Type:	Ball
Auxillary Box Lead Termination:	None	Pulley Face Code:	Standard
Base Indicator:	Rigid	Pulley Shaft Indicator:	Standard
Bearing Grease Type:	Polyrex EM (-20F +300F)	Rodent Screen:	None
Blower:	None	Shaft Extension Location:	Pulley End

<b>Current @ Voltage:</b>	13.400 A @ 230.0 V	<b>Shaft Ground Indicator:</b>	Shaft Grounding
	13.900 A @ 208.0 V	<b>Shaft Rotation:</b>	Reversible
	6.700 A @ 460.0 V	<b>Shaft Slinger Indicator:</b>	No Slinger
<b>Design Code:</b>	B	<b>Speed Code:</b>	Single Speed
<b>Drip Cover:</b>	No Drip Cover	<b>Motor Standards:</b>	NEMA
<b>Duty Rating:</b>	CONT	<b>Starting Method:</b>	Direct on line
<b>Electrically Isolated Bearing:</b>	Not Electrically Isolated	<b>Thermal Device - Bearing:</b>	None
<b>Feedback Device:</b>	NO FEEDBACK	<b>Thermal Device - Winding:</b>	None
<b>Front Face Code:</b>	Standard	<b>Vibration Sensor Indicator:</b>	No Vibration Sensor
<b>Front Shaft Indicator:</b>	None	<b>Winding Thermal 1:</b>	None
		<b>Winding Thermal 2:</b>	None

<b>Nameplate NP3441L</b>										
<b>CAT.NO.</b>	EM3615T-BG									
<b>SPEC.</b>	36Q126S268G1									
<b>HP</b>	5									
<b>VOLTS</b>	230/460									
<b>AMP</b>	13.4/6.7									
<b>RPM</b>	1750									
<b>FRAME</b>	184T				<b>HZ</b>	60			<b>PH</b>	3
<b>SER.F.</b>	1.15		<b>CODE</b>	J	<b>DES</b>	B		<b>CL</b>	F	
<b>NEMA-NOM-EFF</b>	89.5		<b>PF</b>	78						
<b>RATING</b>	40C AMB-CONT									
<b>CC</b>	010A				<b>USABLE AT 208V</b>			13.9		
<b>DE</b>	6206				<b>ODE</b>	6205				
<b>ENCL</b>	TEFC		<b>SN</b>							
<b>VPWM INVERTER READY</b> CT6-60H(10:1)VT3-60H(20:1)										

Parts List		
Part Number	Description	Quantity
SA270203	SA 36Q126S268G1	1.000 EA
RA256842	RA 36Q126S268G1	1.000 EA
36FN3000C01SP	EXFN, PLASTIC, 5.25 OD, .912 ID	1.000 EA
36CB3004	36 CB CASTING W/1.09 DIA LEAD HOLE @ 6:0	1.000 EA
36GS1000SP	GASKET-CONDUIT BOX, .06 THICK #SV-330 LE	1.000 EA
51XB1016A08	10-16X 1/2HXWSSLD SERTYB	2.000 EA
11XW1032G06	10-32 X .38, TAPTITE II, HEX WSHR SLTD U	1.000 EA
36EP3104A01	FREP MACH ASSEMBLY FOR ROUTING	1.000 EA
HW4500A01	1641B(ALEMITE)400 UNIV, GREASE FITT	1.000 EA
HW5100A05	WVY WSHR F/205 & 304 BRGS	1.000 EA
36EP3100A56	ENDPLATE, MACH	1.000 EA
10XN2520A20	1/4-20X 1 1/4 HEX HD X	2.000 EA
HW4500A01	1641B(ALEMITE)400 UNIV, GREASE FITT	1.000 EA
XY2520A12	1/4-20 HEX NUT, DIRECTIONAL SERRATIONS	4.000 EA
51XB1214A16	12-14X1.00 HXWSSLD SERTYB	1.000 EA
36FH4009A102	IEC FH GREASER PRIMED	1.000 EA
51XW1032A06	10-32 X .38, TAPTITE II, HEX WSHR SLTD S	3.000 EA
36CB4516	36 LIPPED CB LID - GALVANNEAL	1.000 EA
37GS1001SP	GASKET, CONDUIT BOX LID, .06 THICK LEXID	1.000 EA
51XW0832A07	8-32 X .44, TAPTITE II, HEX WSHR SLTD SE	4.000 EA
HW2501E16	KEY, 1/4 SQ X 1.750	1.000 EA
HA7000A02	KEY RETAINER RING, 1 1/8 DIA, 1 3/8 DIA	1.000 EA
85XU0407S04	4X1/4 U DRIVE PIN STAINLESS	2.000 EA
LB1508	LABEL "SHAFT GROUNDING BRUSH" 1.50 X .81	1.000 EA

<b>Parts List (continued)</b>		
<b>Part Number</b>	<b>Description</b>	<b>Quantity</b>
HW3200A01	3/8-16X3/4 I-BLT WELDED F/S	1.000 EA
MJ1000A02	GREASE, POLYREX EM EXXON (USe 4824-15A)	0.050 LB
MG1000Y03	MUNSELL 2.53Y 6.70/ 4.60, GLOSS 20,	0.022 GA
LB1115N	LABEL,LIFTING DEVICE (ON ROLLS)	1.000 EA
HA3101A28	THRUBOLT 1/4-20 X 12.500 OHIO ROD	4.000 EA
LC0005E01	CONN.DIA./WARNING LABEL (LC0005/LB1119N)	1.000 EA
NP3441L	ALUM SUPER-E VPWM INVERTER READY UL	1.000 EA
36PA1001	PKG GRP, PRINT PK1017A06	1.000 EA
MN416A01	TAG-INSTAL-MAINT no wire (1200/bx) 5/18	1.000 EA

**AC Induction Motor Performance Data**

Record # 35063 - Typical performance - not guaranteed values

<b>Winding:</b> 36WGS268-R016	<b>Type:</b> 3642M	<b>Enclosure:</b> TEFC
-------------------------------	--------------------	------------------------

Nameplate Data				460 V, 60 Hz: High Voltage Connection	
Rated Output (HP)	5			Full Load Torque	14.9 LB-FT
Volts	230/460			Start Configuration	direct on line
Full Load Amps	13.4/6.7			Breakdown Torque	52.2 LB-FT
R.P.M.	1750			Pull-up Torque	31.5 LB-FT
Hz	60	Phase	3	Locked-rotor Torque	34.9 LB-FT
NEMA Design Code	B	KVA Code	J	Starting Current	49.1 A
Service Factor (S.F.)	1.15			No-load Current	3.24 A
NEMA Nom. Eff.	89.5	Power Factor	78	Line-line Res. @ 25°C	2.27 Ω
Rating - Duty	40C AMB-CONT			Temp. Rise @ Rated Load	71°C
S.F. Amps				Temp. Rise @ S.F. Load	87°C
				Locked-rotor Power Factor	39.8
				Rotor inertia	0.391 LB-FT <sup>2</sup>

Load Characteristics 460 V, 60 Hz, 5 HP

% of Rated Load	25	50	75	100	125	150	S.F.
Power Factor	39	60	72	78	83	83	81
Efficiency	85	89.7	90.6	89.6	88.6	87	89
Speed	1789	1776	1762	1750	1733	1714	1740
Line amperes	3.55	4.31	5.43	6.65	7.94	9.64	7.42

Performance Graph at 460V, 60Hz, 5.0HP Typical performance - Not guaranteed values

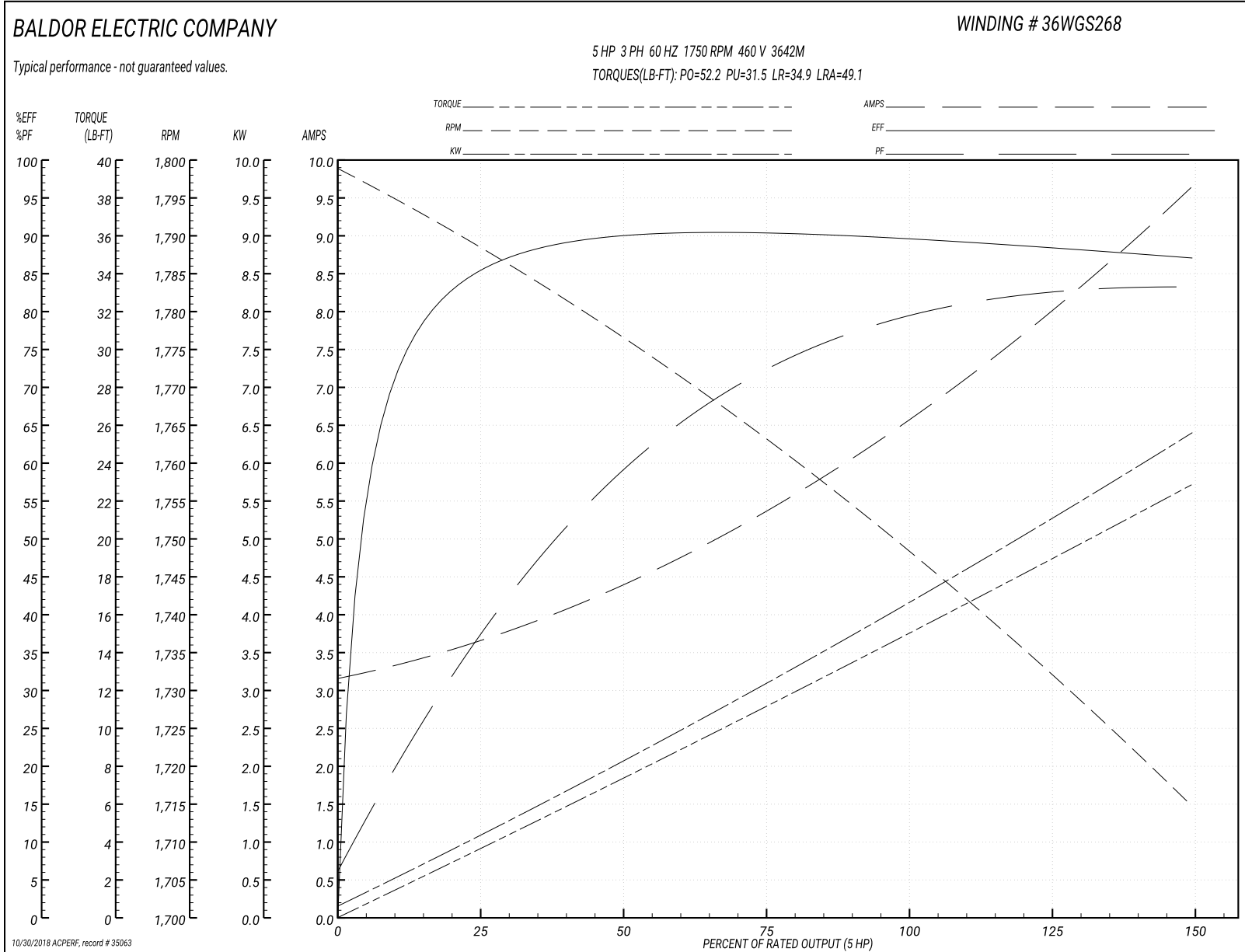



36LYQ126

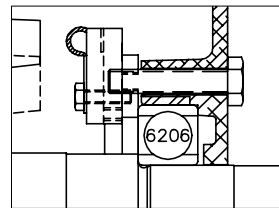
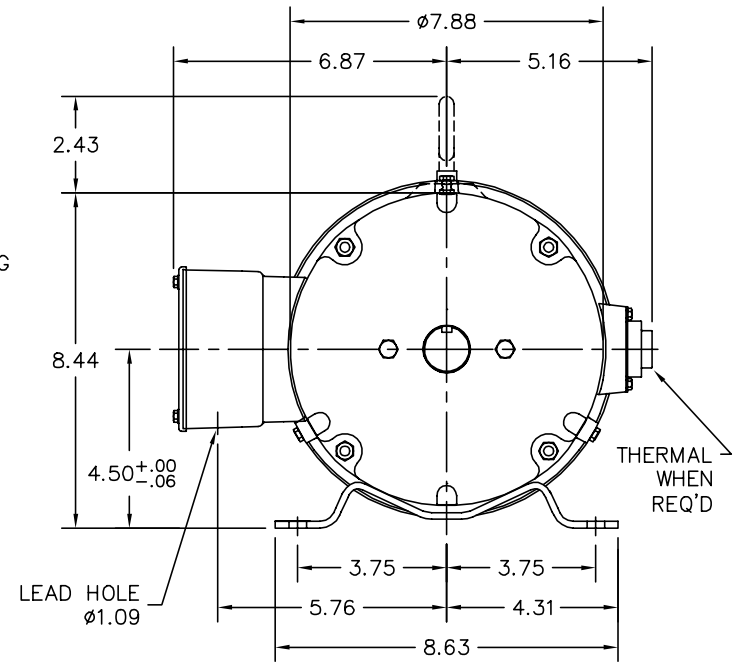
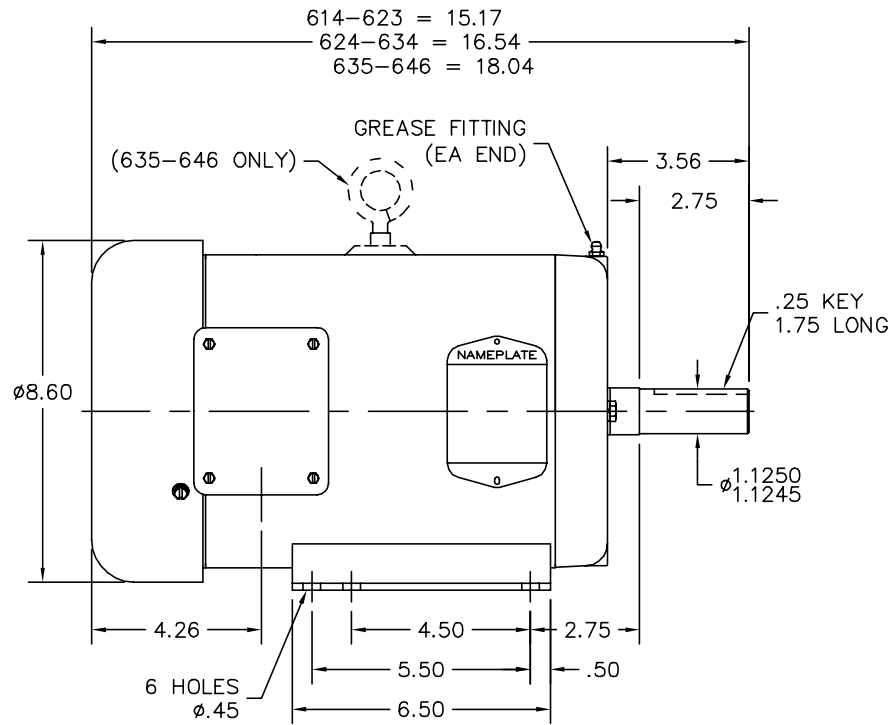

PU END DETAIL

CUSTOMER IS RESPONSIBLE FOR DETERMINING THAT BALDOR'S PRODUCT WILL PERFORM SUITABLY IN THE INTENDED APPLICATION.

REV. DESC: NEW		
REV. LTR: -	VERSION: 00	TDR: 000000820155
FILE: \AAA\00203\915	REVISED: 08:22:45 10/03/2013	BY: ENTANWO
MTL: -		

**BALDOR**

HOR 182-4T TEFC M, BALDOR INT SHAFT GND

SH 1 of 1

36LYQ126

CD0005

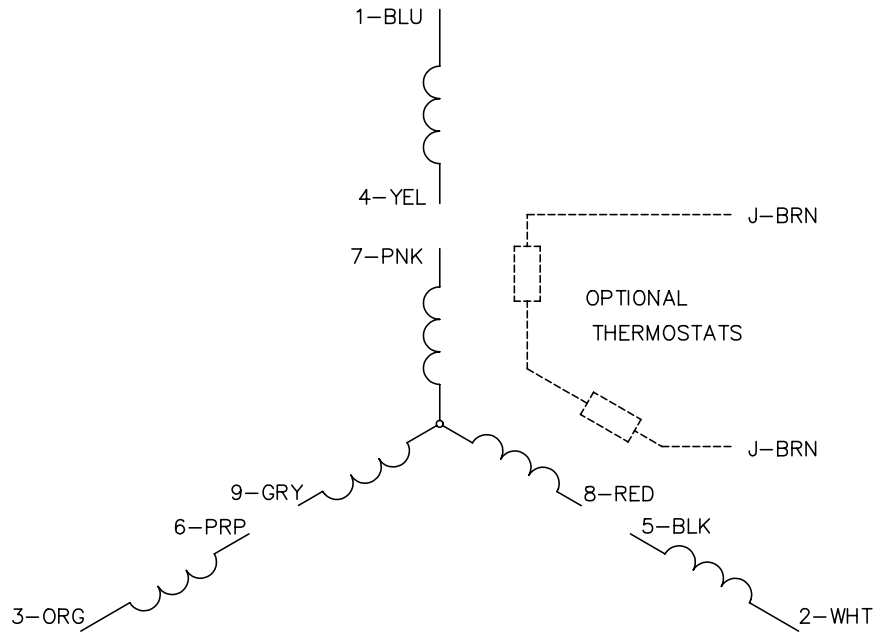

LOW VOLTAGE  
(2Y)

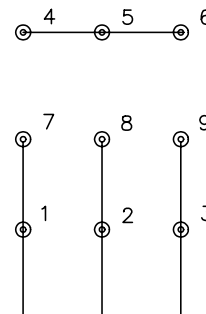

LINE

HIGH VOLTAGE  
(1Y)

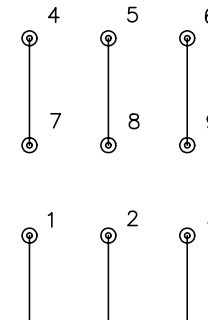

LINE

NOTES:

1. INTERCHANGE ANY TWO LINE LEADS TO REVERSE ROTATION.
2. OPTIONAL THERMOSTATS ARE PROVIDED WHEN SPECIFIED.
3. ACTUAL NUMBER OF INTERNAL PARALLEL CIRCUITS MAY BE A MULTIPLE OF THOSE SHOWN ABOVE.
4. LEAD COLORS ARE OPTIONAL. LEADS MUST ALWAYS BE NUMBERED AS SHOWN.

REV. DESC: REVISE TO SHOW OPTIONAL COLORS

REV. LTR: E BY: JLP

REVISED: 01/19/99 10:15

TDR: 0171435

9000D

FILE: AAA00005140

MDL: -

MTL: -

**BALDOR ELECTRIC Co.**

3PH, DV, 9 LEADS

CD0005