

Grundfos Variable Speed

Circulator pumps incorporating variable speed control (VS) with date code 0838 or higher

Installation and operating instructions



be
think
innovate

GRUNDFOS 

English (US) Installation and operating instructions

Original installation and operating instructions.

CONTENTS

	Page
1. General warning	2
2. Limited warranty	2
3. Symbols used in this document	3
4. Product introduction	3
4.1 Introduction	3
4.2 Delivery and handling	3
4.3 Applications	4
4.4 Features and benefits	4
5. Operating conditions	4
5.1 Control signal input range options	4
6. Installation	5
6.1 Installation requirements	5
6.2 Mechanical installation	5
6.3 Electrical installation	6
7. Settings	7
7.1 Setting the dip switches	7
7.2 Speed settings	7
8. After installation	8
9. Quick reference	8
10. Disposal	9

1. General warning

Warning



Prior to installation, read these installation and operating instructions. Installation and operation must comply with local regulations and accepted codes of good practice.

Warning



This booklet should be left with the owner of the pump for future reference and information regarding its operation.

2. Limited warranty

Products manufactured by GRUNDFOS PUMPS CORPORATION (Grundfos) are warranted to the original user only to be free of defects in material and workmanship for a period of 24 months from date of installation, but not more than 30 months from date of manufacture. Grundfos' liability under this warranty shall be limited to repairing or replacing at Grundfos' option, without charge, FOB Grundfos' factory or authorized service station, any product of Grundfos' manufacture. Grundfos will not be liable for any costs of removal, installation, transportation, or any other charges which may arise in connection with a warranty claim. Products which are sold but not manufactured by Grundfos are subject to the warranty provided by the manufacturer of said products and not by Grundfos' warranty. Grundfos will not be liable for damage or wear to products caused by abnormal operating conditions, accident, abuse, misuse, unauthorized alteration or repair, or if the product was not installed in accordance with Grundfos' printed installation and operating instructions.

To obtain service under this warranty, the defective product must be returned to the distributor or dealer of Grundfos' products from which it was purchased together with proof of purchase and installation date, failure date, and supporting installation data. Unless otherwise provided, the distributor or dealer will contact Grundfos or an authorized service station for instructions.

Any defective product to be returned to Grundfos or a service station must be sent freight prepaid; documentation supporting the warranty claim and/or a Return Material Authorization must be included if so instructed. GRUNDFOS WILL NOT BE LIABLE FOR ANY INCIDENTAL OR CONSEQUENTIAL DAMAGES, LOSSES, OR EXPENSES ARISING FROM INSTALLATION, USE, OR ANY OTHER CAUSES. THERE ARE NO EXPRESS OR IMPLIED WARRANTIES, INCLUDING MERCHANTABILITY OR FITNESS FOR A PARTICULAR PURPOSE, WHICH EXTEND BEYOND THOSE WARRANTIES DESCRIBED OR REFERRED TO ABOVE.

Some jurisdictions do not allow the exclusion or limitation of incidental or consequential damages and some jurisdictions do not allow limit actions on how long implied warranties may last. Therefore, the above limitations or exclusions may not apply to you. This warranty gives you specific legal rights and you may also have other rights which vary from jurisdiction to jurisdiction.

3. Symbols used in this document



Warning

If these safety instructions are not observed, it may result in personal injury.



Warning

If these instructions are not observed, it may lead to electric shock with consequent risk of serious personal injury or death.

Caution

If these safety instructions are not observed, it may result in malfunction or damage to the equipment.

Note

Notes or instructions that make the job easier and ensure safe operation.

4. Product introduction

4.1 Introduction

Grundfos pumps are carefully inspected and tested before shipment. This Variable Speed pump should provide long, efficient, trouble-free performance. For maximum performance and reliability, please follow the simple instructions in this manual.

When installing and using this electrical equipment, basic safety precautions and local code requirements should always be followed, including the following:

The installer must ensure that the controller and its wiring are isolated and/or shielded from strong sources of electromagnetic noise. In addition, this Class B digital apparatus complies with Part 15 of the FCC Rules and meets all requirements of the Canadian Interference-Causing Equipment Regulations. However, if this controller does cause harmful interference to radio or television reception, which can be determined by turning the controller off and on, the user is encouraged to try to correct the interference by reorienting or relocating the receiving antenna, relocating the receiver in relation to the controller, and/or connecting the controller to a different circuit from that to which the receiver is connected.

Caution

Warning

Improper installation and operation of this controller could result in damage to the equipment and possibly even personal injury. It is your responsibility to ensure that this controller is safely installed according to all applicable codes and standards. This electronic controller is not intended for use as a primary limit controller. Other controllers that are intended and certified as safety limits must be placed into the control circuit.



Warning

All field wiring must be low voltage. Power for the controller is provided through the power cord supplying power to the pump. Use copper conductors only. Disconnect all power sources prior to servicing.



Warning

Risk of electric shock: This pump is supplied with a grounding conductor and grounding-type attachment plug. To reduce the risk of electric shock, be certain that it is connected only to a properly grounded, grounding type receptacle.



4.2 Delivery and handling

Examine the components carefully to make sure no damage has occurred to the pump during shipment. **Take care to ensure the pump is NOT dropped or mishandled; dropping will damage the pump.**

Grundfos Variable Speed pump package includes:

- one Grundfos UP 15-42 Variable Speed pump with integral controller or one Grundfos UP 26 Variable Speed pump with integral controller
- one 6 ft (1.8 m) power cord with 115 V plug, pre-wired into control unit
- two flange gaskets
- installation and operating instructions.

4.3 Applications

4.3.1 Pumped liquids

Grundfos Variable Speed pumps are designed to pump liquids compatible with their cast iron pump housing construction. They are recommended for use in closed hydronic systems.

Caution *Grundfos Variable Speed pumps are for indoor use only.*

Caution *Grundfos Variable Speed pumps are intended for use with water, or a 50/50 mixture by weight of propylene glycol.*

4.4 Features and benefits

- All minimum and maximum settings are operating, not safety limits.
Necessary auxiliary equipment and safety devices must be added.
- "Offset %" dial provides fine-tuning for input signal.
- "Manual %" dial provides manual speed control.
- Signal range is selected through dip switch A.
- Type of signal used is selected through dip switch B.
- Minimum speed at 0 or 15 % is selected through dip switch C.
- Speed control from external signal or "Manual %" dial is selected through dip switch D.
- Pump exercising:
After every three days of no operation, the controller will exercise the pump for 10 seconds. The "% Out" LED will be on during exercising.
- As variable speed output modulates, the "% Out" LED will flash at speeds varying from ON for 0.25 seconds and OFF for 0.25 seconds up to ON for 2.5 seconds and OFF for 2.5 seconds.
- The output % will be 100 % for 3 seconds after power is applied. This is the same for all modes of operation.
See figs 4 to 7.

5. Operating conditions

5.1 Control signal input range options

Voltage signal range: 0-10 V(DC) or 2-10 V(DC)

Current signal range: 0-20 mA or 4-20 mA.

5.1.1 UP 15-42 F/VS, 115 V 60 Hz

Maximum liquid temperature:

- 205 °F (96 °C)

Maximum ambient temperature:

- 107 °F (42 °C) with control module vertical (see fig. 1)
- 105 °F (41 °C) with control module on top of pump and horizontal (see fig. 1)

Maximum working pressure:

- 145 psi (10 bar)

Minimum inlet pressure:

- 5 psi (0.34 bar).

5.1.2 UP 26-96 F/VS, 115 V 60 Hz and UP 26-64 F/VS, 115 V 60 Hz

Maximum liquid temperature:

- 195 °F (90 °C)

Maximum ambient temperature:

- 105 °F (40 °C) with control module vertical (see fig. 1)
- 92 °F (33 °C) with control module on top of pump and horizontal (see fig. 1)

Maximum working pressure:

- 145 psi (10 bar)

Minimum inlet pressure:

- 5 psi (0.34 bar).

6. Installation

Caution Consult pipe manufacturers for material selection before installing this pump. Absence of pumped liquid may damage some piping materials.

Caution Thoroughly clean and flush the system prior to pump installation.

Caution For indoor use only.

6.1 Installation requirements

1. Ensure that water does not enter the terminal box during the installation process.
2. **DO NOT START THE PUMP** until the system has been filled and checked for leaks.
3. Do not use the pump to vent the system.
4. Never let the pump run dry. The bearings require water lubrication and will be damaged otherwise.
5. Fill system with water. This will result in immediate lubrication of the bearings.
6. Thoroughly clean and flush the system prior to pump installation.
7. Operate the pump for 5 minutes, when controller installation is complete, to purge remaining air from the bearing chamber. This is especially important when installing the pump during the off-season.
8. When making pipe connections, be sure to follow the pipe manufacturer's recommendations and all code requirements for piping material.

6.2 Mechanical installation

6.2.1 Preferred pump and terminal box orientation

Arrows on the side or bottom of the pump housing indicate direction of flow through the pump.

The pump must be installed with the motor shaft positioned horizontally. Under no circumstances should the pump be installed with the shaft vertical or where the shaft falls below the horizontal plane. See fig. 1.

Warning
 If the terminal box position needs to be changed, ensure that the power supply is turned off and close the isolating valves before removing the hex socket head screws.

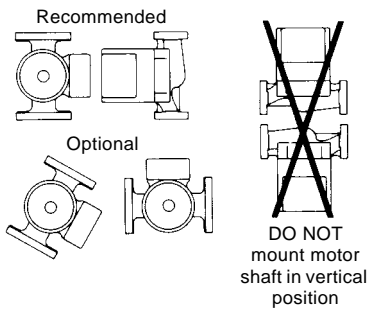

Fig. 1 Terminal box orientation

6.2.2 How to change terminal box position

Warning
 If the terminal box position needs to be changed, ensure that the power supply is turned off and close the isolating valves before removing the hex socket head screws.

How to change terminal box position:

1. Remove the four (4) hex socket head screws (4 or 5 mm wrench) while supporting the stator (motor).
2. Carefully separate the stator from the pump housing and rotate it to the correct terminal box orientation.
3. Replace the hex socket head screws and tighten diagonally and evenly (7 ft.-lb. torque).
4. Check that the motor shaft turns freely. Remove the large screw in the middle of the nameplate, insert a small flat-blade screwdriver into the end of the shaft, and turn gently.
5. If the shaft does not turn easily, repeat the disassembly/reassembly process.

6.3 Electrical installation



Warning

All electrical work should be performed by a qualified electrician in accordance with the latest edition of the National Electrical Code, local codes and regulations.



Warning

Power must not be applied to any voltage supply wiring.

Caution

All field wiring must pass through a suitable, listed conduit fitting, to ensure proper strain relief.

Caution

All field installed wiring should meet or exceed requirements for Class 2 wiring per article 725 of the National Electrical Code rated at 30 VAC 250 VA. Ensure that enough wiring is in the terminal box to reach the terminal board.

Note

All field wiring shall have insulation stripped exposing 5-7 mm of conductor before placement into terminal box terminal board.

If rigid conduit is to be used, the hub must be connected to the conduit system before it is connected to the terminal box of the pump.

6.3.1 Electrical connections to the controller



Warning

The installer should make sure that no current/voltage is present at any of the wires.

Note

Control signal wires must be run through and secured by the strain relief on the terminal board.

Note

No speed control signal is necessary if speed is to be regulated using the manual % dial.

Current speed control signal connections

Connect the current signal wires to terminals "Com(-)" and "Ret/I". See fig. 2.

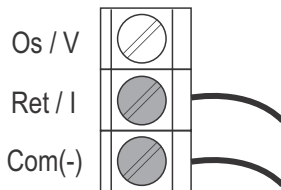

TM05 4629 2512

Fig. 2 Current connections to the ("Com(-)" and "Ret/I") control

Voltage speed control signal connections

Connect the voltage signal wires to terminals "Com(-)" and "Os/V". See fig. 3.

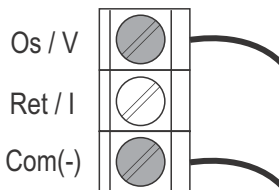

TM05 4630 2512

Fig. 3 Voltage connections to the ("Com(-)" and "Os/V") control

Test the speed control signal wiring

Make sure exposed wires and bare terminals are not in contact with other wires or grounded surfaces. Turn on the control signal and measure the voltage/mA across the wires using a voltmeter to confirm the pump signal is present.

7. Settings

7.1 Setting the dip switches

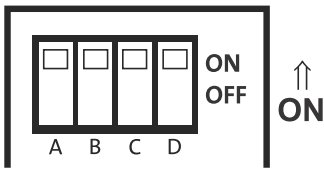

TM05 4632 2512

Fig. 4 Dip switches

7.1.1 Dip switch settings

Switch	Position		Default
	ON	OFF	
A	mA	(V) DC	mA
B	2-10 V 4-20 mA	0-10 V 0-20 mA	2-10 V 4-20 mA
C	Min. speed off	Min. speed 15 %	Min. speed off
D	Speed control external	Speed control manual % dial	Speed control external

7.2 Speed settings

7.2.1 Dip switch C

Minimum speed off / minimum speed 15 %

When dip switch C is in the **ON** position the variable speed of the pump will have a range from minimum speed = off to maximum speed = 100 %. When dip switch C is in position **OFF** the variable speed of the pump will have a range from minimum speed = 15 % to a maximum speed = 100 %.

7.2.2 Dip switch D

Speed control external / speed control maximum % dial

When dip switch D is in position **ON**, an external V(DC)/mA signal will cause the pump speed to vary and the dial on the terminal box will function in the -5 % to +5 % mode. When dip switch D is in position **OFF**, turning the manual % dial will vary the pump speed. The pump will not respond to an external V(DC)/mA signal even if one is present. The terminal box and the dial will function in the minimum to 100 % mode.

7.2.3 Multi function dial on terminal box

Offset dial (when dip switch D is on)

The Offset dial allows the user to fine-tune the input signal. The input signal may be varied plus or minus 1-5 %. This offset will affect the signal through its entire range. The factory default is 0. The offset setting cannot increase the output to more than 100 % or less than the selected minimum output of either 0 % or 15 %.

Example:

The measured input signal is 2.1 - 10.1 V and as a result the pump does not shut off because the signal does not drop to 2 V. The dial is set to -5 % and the input signal is offset down to 2.0 - 9.6 V. The pump will now shut off; however the pump will not reach the full 10 V speed now, due to the offset.

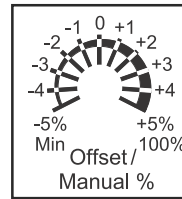

Fig. 5 Offset in percent

TM05 4631 2512

7.2.4 Manual % dial (when dip switch D is off)

The manual % dial allows the speed of the pump to be manually adjusted and set by the user. The speed of the pump may be manually adjusted anywhere from "Min" to "100 %", but once set remains fixed at that speed. The "Min" position on the dial will either be equal to OFF or 15 % depending on the position of dip switch C. The factory default is 50 %.

Insert power cord from the pump into a properly grounded 115 V outlet. This will apply power to the pump/controller.

7.2.5 Performance indicator LEDs

"Power On" (green) indicates that power is applied.

"% Out" (yellow) indicates the speed of the pump by flashing at different speeds.

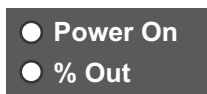

Fig. 6 Performance indicator LEDs

8. After installation

- Place this manual, and all other manuals relating to the installation, in a location near the controller for future reference.
- It is important to explain the operation of this controller to the end user and to anyone else who may be operating the system.

TM05 4637 2512

9. Quick reference

Voltage speed control signal circuit rating:

Terminals: "Com (-)" and "Os/V"

- 0-10 VDC
- 5 mA max.

Current speed control signal circuit rating:

Terminals: "Com(-)" and "Ret/I"

- 0-20 mA DC
- 5 VDC max.

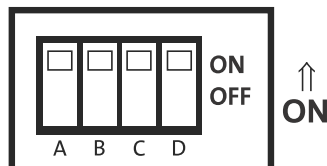

Fig. 7 Dip switches

TM05 4632 2512

Switch	Dip switch position		
	ON	OFF	Default
A	mA	(V) DC	mA
B	2-10 V 4-20 mA	0-10 V 0-20 mA	2-10 V 4-20 mA
C	Min. speed off	Min. speed 15 %	Min. speed off
D	Speed control external	Speed control manual % dial	Speed control external

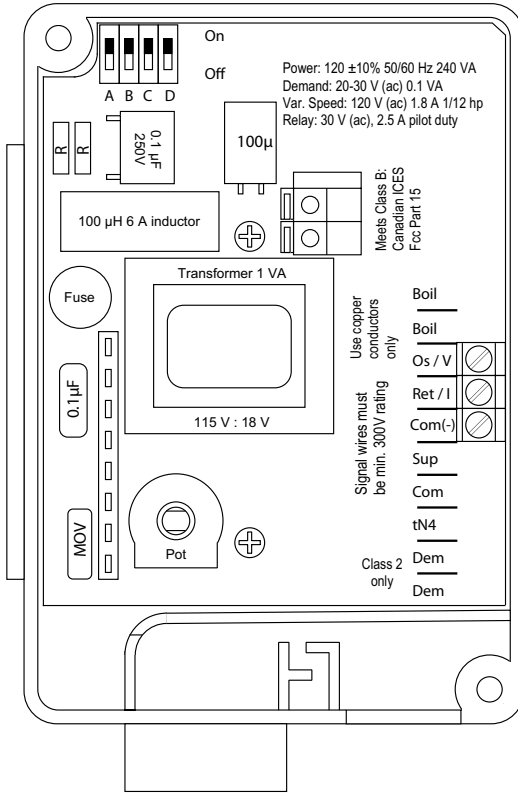

Fig. 8 Grundfos Variable Speed control board

10. Disposal

This product or parts of it must be disposed of in an environmentally sound way:

1. Use the public or private waste collection service.
2. If this is not possible, contact the nearest Grundfos company or service workshop.

Subject to alterations.

GRUNDFOS Kansas City

17100 West 118th Terrace
Olathe, Kansas 66061
Phone: (913) 227-3400
Fax: (913) 227-3500

www.grundfos.us

GRUNDFOS Canada

2941 Brighton Road
Oakville, Ontario L6H 6C9 Canada
Phone: +1-905 829 9533
Telefax: +1-905 829 9512

www.grundfos.ca

GRUNDFOS México

Boulevard TLC No. 15
Parque Industrial Stiva Aeropuerto
C.P. 66600 Apodaca, N.L. México
Phone: 011-52-81-8144 4000
Fax: 011-52-81-8144 4010

www.grundfos.mx

L-UP-TL-042

98358685 0814

ECM: 1139039

The name Grundfos, the Grundfos logo, and **be think innovate** are registered trademarks owned by Grundfos Holding A/S or Grundfos A/S, Denmark. All rights reserved worldwide. © Copyright Grundfos Holding A/S