

CR-H, CRN-H 32•45•64•90 Dismantling & Reassembly

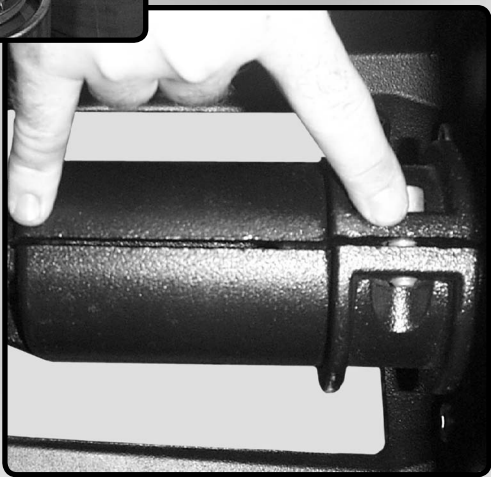

CONTENTS

Dismantling Procedures..... Page 2
 When Should A Part Be Replaced ?.....Page 12

Reassembly ProceduresPage 13
 Setting The Coupling Height.....Page 24
 Order of Stage Assembly - CR-H, CRN-H 32.....Page 27
 Order of Stage Assembly - CR-H, CRN-H 45.....Page 28
 Order of Stage Assembly - CR-H, CRN-H 64.....Page 29
 Order of Stage Assembly - CR-H, CRN-H 90.....Page 30

TORQUES

| Position Number | | |
|-----------------|--|--------------------|
| 7a | Screw for Guard | 6 ft.-lbs./8 Nm |
| 9 | Coupling Screws | 63 ft.-lbs./85 Nm |
| 26b | Allen Screw for Strap | 11 ft.-lbs./15 Nm |
| 28 | Allen Screw Motor Stool to Pump Head | 46 ft.-lbs./62 Nm |
| 28a | Allen Screw for Motor 1/2" x 13 UNC, 3-40 HP | 30 ft.-lbs./40 Nm |
| | 5/8" x 11 UNC, 50-60 HP | 59 ft.-lbs./80 Nm |
| 28g | Allen Screw for Foot/Base | 15 ft.-lbs./20 Nm |
| 31 | Allen Screw for Bottom Stationary Bearing | 6 ft.-lbs./8 Nm |
| 35 | Allen Screw for Discharge Flange | 15 ft.-lbs./20 Nm |
| 36 | Staybolt Nut | 74 ft.-lbs./100 Nm |
| 48 | Split Cone Nut | 52 ft.-lbs./70 Nm |
| 56 c/e | Allen Screw for Sleeve Flange CR-H, CRN-H32, M12 | 55 ft.-lbs./75 Nm |
| | CR-H, CRN-H 45/64/90, M16 | 74 ft.-lbs./100 Nm |
| 58a & | | |
| 58d | Allen Screw Seal Carrier | 46 ft.-lbs./62 Nm |
| 67 | Allen Screw for Shaft Bearing | 23 ft.-lbs./31 Nm |
| 113 | Allen Set Screw for Shaft Seal | 6 ft.-lbs./8 Nm |

Dismantling Procedures CR-H, CRN-H 32•45•64•90

In the instructions below, the numbers in parenthesis (7) indicate the position number of that part as it is shown on the Parts List and Kits diagram.

These instructions cover the repair of the pump after it has been isolated from the system. Before removing the pump from the system, make sure all valves are closed. Relieve any built-up pressure by opening the vent plug screw. The power source should be turned off and locked out before starting any work. Removal of field wiring to the motor may be required. Color coding or numbering the wires will aid in reinstallation.

For shaft seal change only

Standard unit or a Cool Top®, follow steps 1 to 7.

Pumps built with Back-to-Back seals, follow steps 1 to 10.

Pumps built with Tandem/Quench seals, follow steps 25 to 39.



Loosen, **but do not remove**, Coupling Guard Screws (Pos. 7a). Remove Coupling Guards (Pos. 7) from the Motor Stool (Pos. 1a).

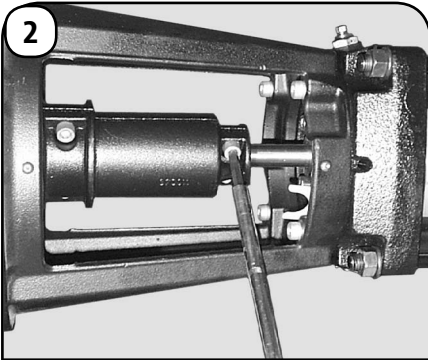

Use an Allen wrench with an 8 mm tip to loosen and remove the Coupling Screws (Pos. 9) from the Coupling Halves (Pos. 10a).

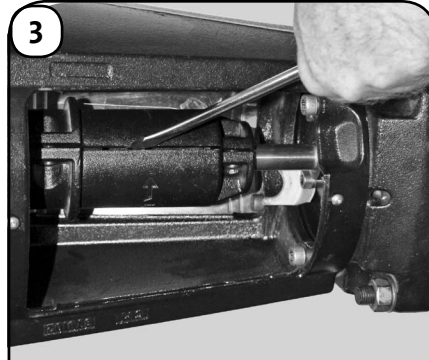

To remove the coupling halves, insert a flat/slot blade screwdriver in the coupling gap and twist to free the first coupling half.

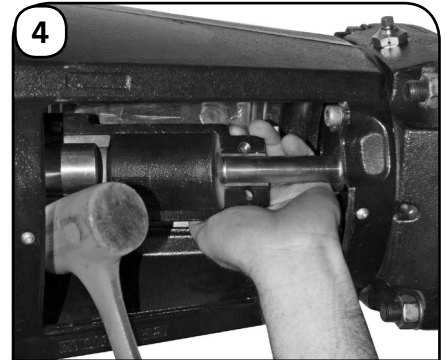

To free/remove the remaining coupling half nearest the motor shaft, strike the edge of the coupling half with a rubber mallet.

Note: If you have multiple pumps, do not interchange coupling components, they are a matched set.



Remove the 8 mm socket Allen Screws (Pos. 58a) from the Seal Retainer (Pos. 58). Remove the retainer.

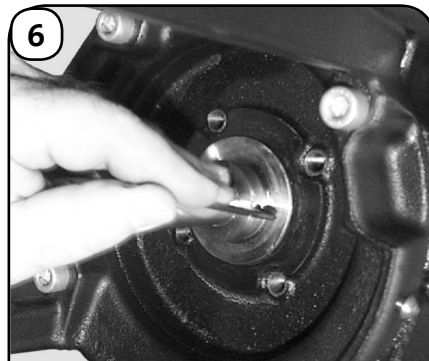

Loosen, **but do not remove**, the 3 mm Set Screws (Pos. 113) from the Shaft Seal (Pos. 105).

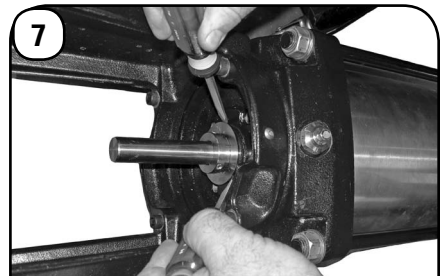

Use two flat/slot blade screwdrivers to pry the seal loose. Slide the seal (Pos. 105) completely off the shaft (Pos. 51). For seal change on Standard and Cool Top pumps only, go to the Reassembly section, step 54. For STACK® (Pos. 80) replacement, Back-to-Back Inboard Seal (Pos. 105b) and Cool Top® Connecting Pipe (Pos. 149) removal, continue with step 9.

8 **Pos. 105**



Cartridge Seals
Will lift out as a complete assembly.

9

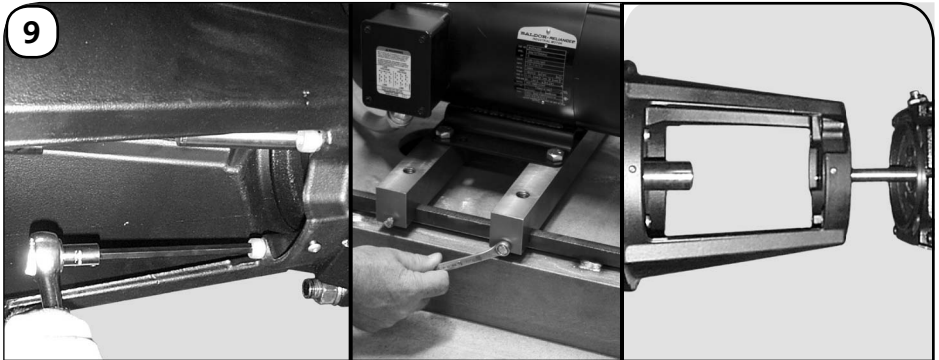

To remove the motor stool (Pos. 1a) and motor: If needed, place a block under the Support Bracket (Pos. 90c). Loosen and remove the Allen Screws (Pos. 28) connecting the motor stool to the pump head. Leave the motor stool attached to the motor and/or bearing flange to protect the motor shaft and bearing flange shaft. Loosen the Slide Rail (Pos. 90d) connecting the motor to the Base (Pos. 90), then slide the motor backward on the base. If sliding provisions are not available on the base or when working on Cool-Top and Back-to-Back models, use a lifting device to lift and remove the motor assembly

10

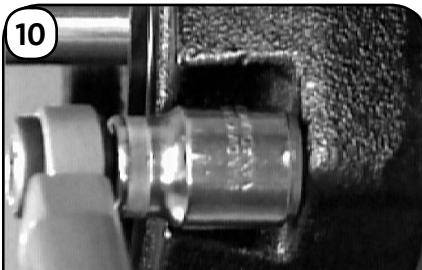

All models requiring full dismantling for STACK® (Pos. 80) replacement: Loosen but do not remove the 24 mm Staybolt Nuts (Pos. 36). Then, proceed to Dismantling, step 40. For Back-to-Back inboard seal change, continue by first placing blocking under the staybolts. Then, remove the Staybolt Nuts, Washers (Pos. 66a) and Support Plate (Pos. 90c).

11 **Back-to-Back Seal**

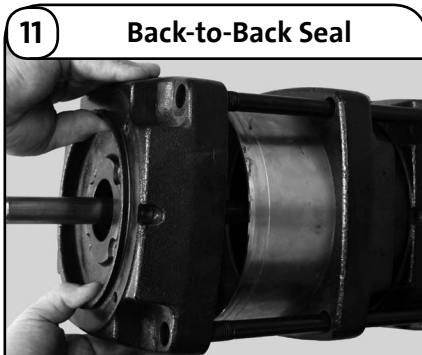

Remove the outermost Pump Head (Pos. 2b). This may require light blows with rubber mallet to the underside of the pump head.

12 **Back-to-Back Seal**

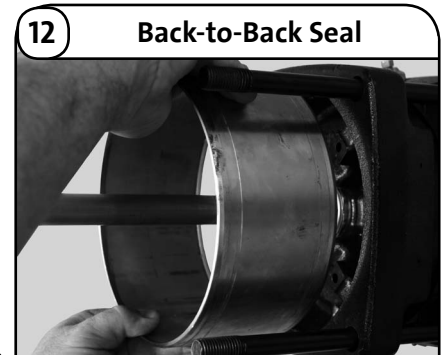

To remove the Outer Sleeve (Pos. 55a), diagonally grip the Staybolts (Pos. 26). Use your thumbs to press against the sleeve to release the sleeve from the middle pump head. If it does not move freely, light blows with a rubber mallet may be required. Once loose, remove the sleeve.

13 **Back-to-Back Seal**

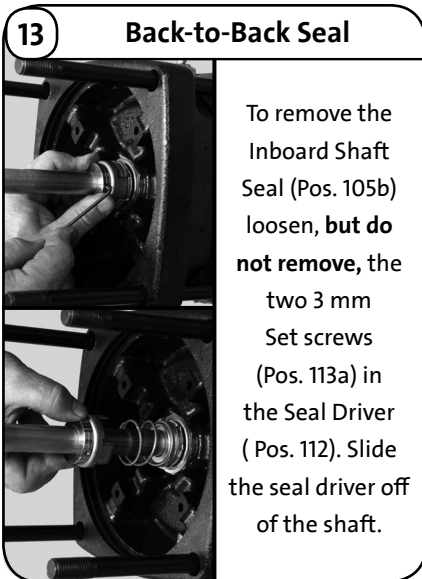

To remove the Inboard Shaft Seal (Pos. 105b) loosen, but do not remove, the two 3 mm Set screws (Pos. 113a) in the Seal Driver (Pos. 112). Slide the seal driver off of the shaft.

14 **Back-to-Back Seal**

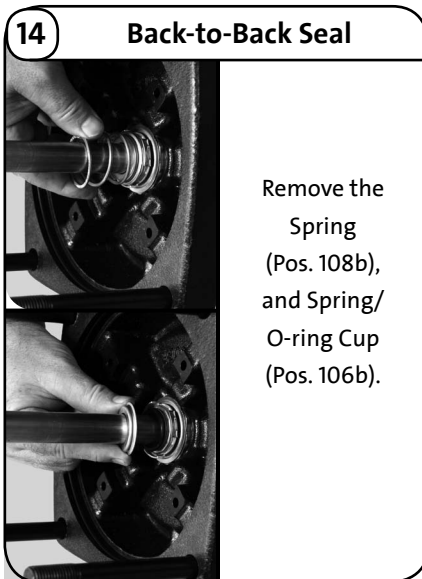

Remove the Spring (Pos. 108b), and Spring/O-ring Cup (Pos. 106b).

15 **Back-to-Back Seal**

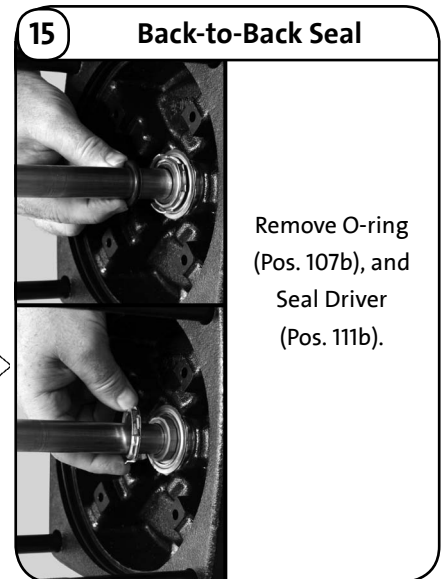

Remove O-ring (Pos. 107b), and Seal Driver (Pos. 111b).

Back-to-Back Seal (continued)

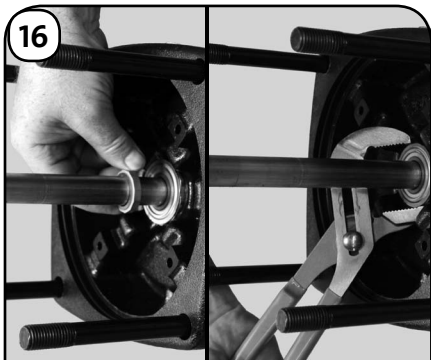

16

Remove the Rotating Seal Face (Pos. 104b). Then, use adjustable pliers or a 53 mm (2-1/8 in.) wrench to remove the Threaded Seal Retainer (Pos. 148).



17

Slide the threaded seal retainer off the shaft. Next, slide the Retaining Washer (Pos. 59e) off the shaft.

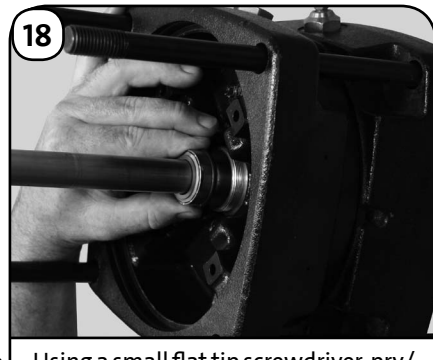

18

Using a small flat tip screwdriver, pry/loosen the stationary seal from the Connecting Pipe (Pos. 149). Slide the seal off the shaft.

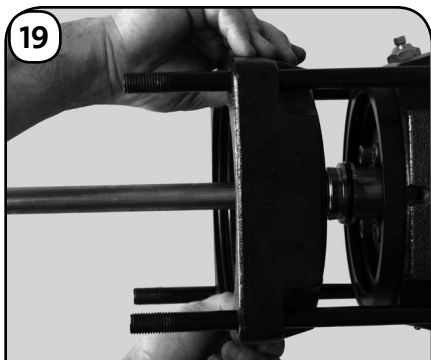

19

Slide/remove the middle pump head (Pos. 20).

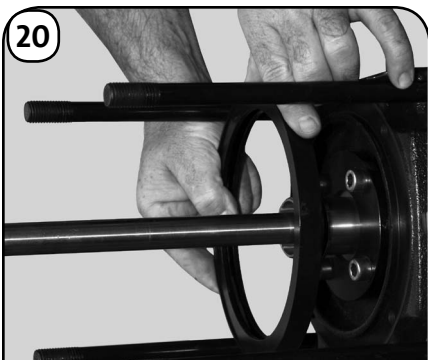

20

Remove the Spacing Ring (pos. 116).

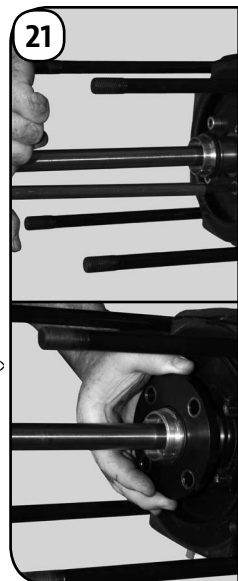

21

Loosen and remove the 8 mm hex socket Retainer Screws (Pos. 58d).

Remove the Connecting Pipe Retainer (Pos. 58c).

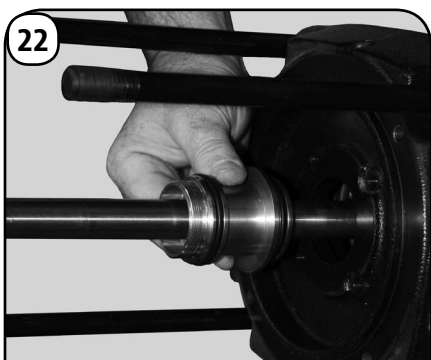

22

Remove the Connecting Pipe (Pos. 149) and the innermost Pump Head (Pos. 2).



23

Place the connecting pipe into one of the pump heads. Use 005V2128 and a rubber mallet to drive out the Retainer Ring (Pos. 47h) and Bushings (Pos. 47g).



24

Remove the O-rings (Pos. 109a and 109b). For reassembly of the seal and connecting pipe, go to the Reassembly section, step 17. To continue disassembly, proceed to step 40.

Tandem Seal

25

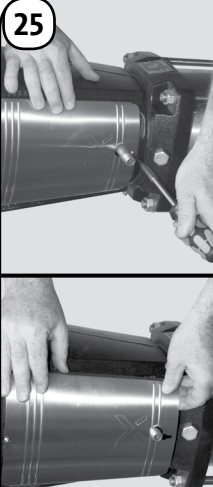

Loosen the top Coupling Guard Screw (Pos. 7a), but do not fully remove. Loosen and fully remove the lower screw. Tilt and slide the Coupling Guards (Pos. 7) off of the system flush piping.

26

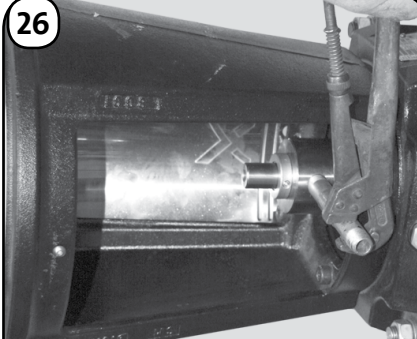

Remove system flush piping.

27

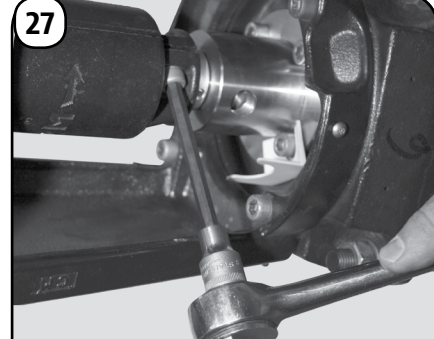

Use an Allen wrench with an 8 mm tip to loosen and remove the Coupling Screws (Pos. 9) from the Coupling Halves (Pos. 10a).

28

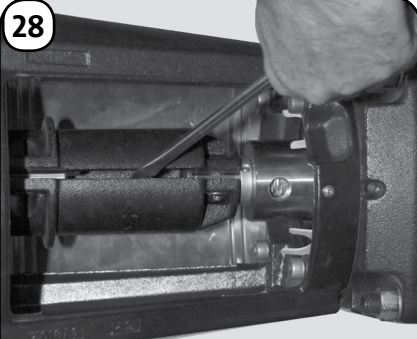

To remove the coupling halves, insert a flat/slot blade screwdriver in the coupling gap and twist to free the first coupling half.

29

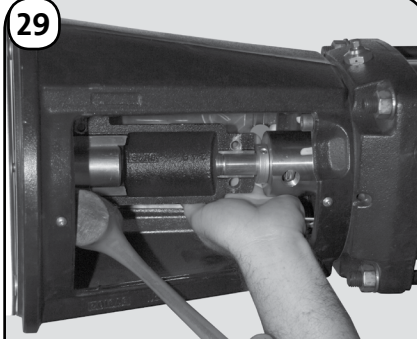

To free/remove the remaining coupling half, strike the upper edge of the coupling half with a rubber mallet. **Note:** If you have multiple pumps, do not interchange coupling components, they are a matched set.

30

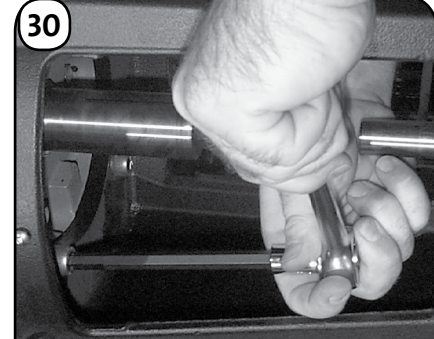

If the motor needs to be removed to change the seals, remove the motor to pump Bolts (Pos. 28a). Remove motor off of Motor Stool (Pos. 1a).

31

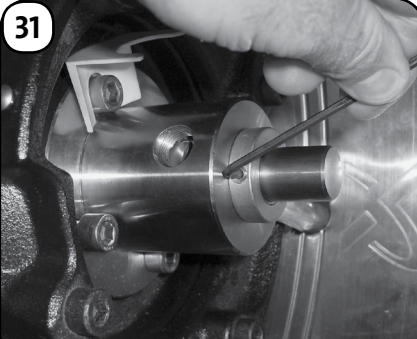

Loosen, **but do not remove**, the 3 mm Set Screws (Pos. 113) from the Tandem Shaft Seal (Pos. 105c).

32



Loosen and remove the 8 mm hex socket Allen Screws (Pos. 58a) holding the seal housing.

33

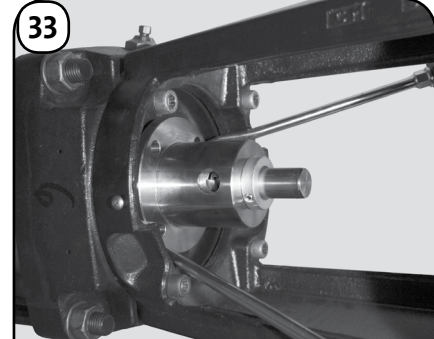

Use two flat/slot blade screwdrivers to pry the seal loose. Slide the Seal (Pos. 105c) completely off of the Shaft (Pos. 51). Once removed, fully unscrew the set screws (Pos. 113) and 105c can be completely disassembled, see exploded view on page 6.

Tandem Seal (continued)

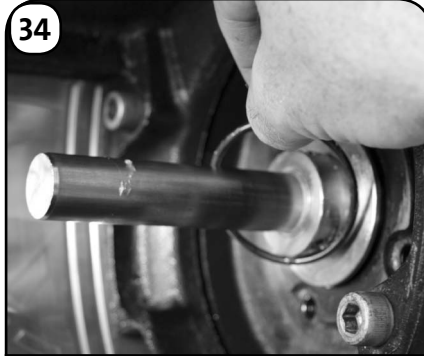
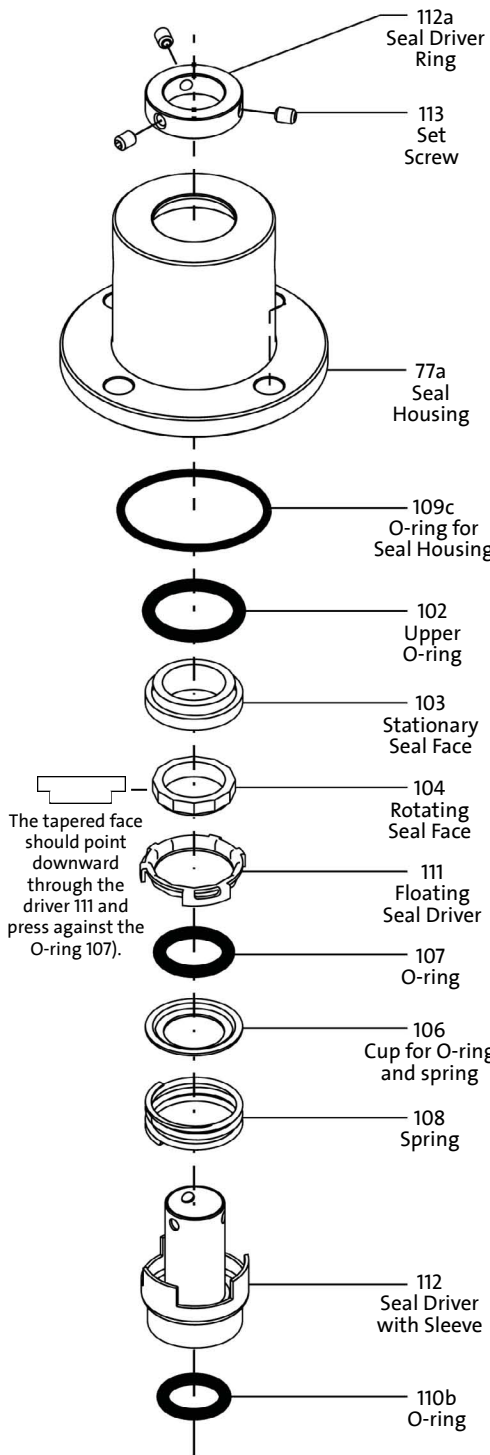

34
Remove the Tandem Seal Housing O-ring (Pos. 109c).

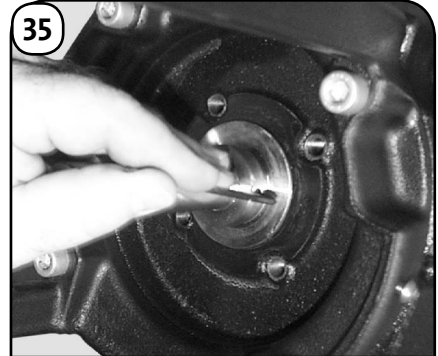

35
Loosen, **but do not remove**, the 3 mm Set Screws (Pos. 113) from the Shaft Seal (Pos. 105).

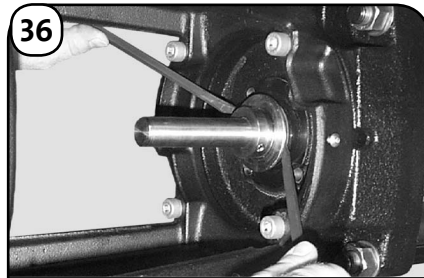

36
Use two flat/slot blade screwdrivers to pry the seal loose. Lift the seal completely off the shaft. For seal change only, go to the Reassembly section, step 54. To continue disassembly, proceed to step 38.



37 Pos. 105
Cartridge Seals
Will lift out as a complete assembly.

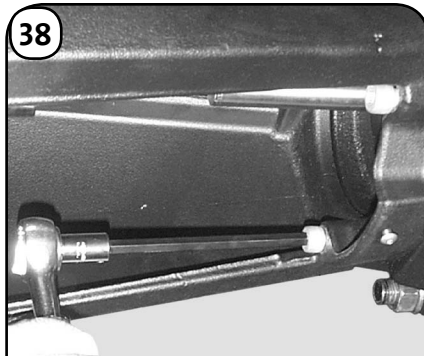

38
Loosen and remove the 8 mm hex socket Allen Screws (Pos. 28) connecting the motor stool to Pump Head (Pos. 2).



39
Loosen (but do not remove) the 24 mm Staybolt Nuts (Pos. 36) and Washers (Pos. 66a). Proceed to Dismantling, step 40.

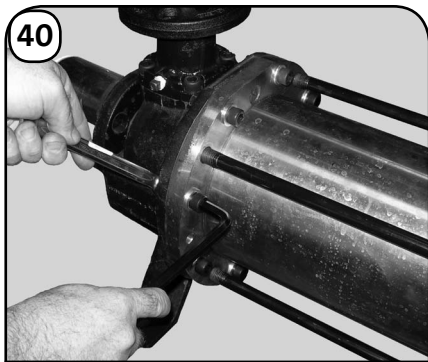

40

Loosen and remove all the Sleeve Flange Nuts (Pos. 56e), Allen Screws (Pos. 56c), and Washers (Pos. 56d) from the Sleeve Flange (Pos. 55b).



41

Remove the plastic plugs from the threaded jacking holes. Next, use two of the sleeve flange allen screws and place into the threaded holes of the sleeve flange. Tightened diagonally, this will force the cartridge assembly (Pos. 80a) away from the Suction/Discharge Base (Pos. 6). **Warning:** Do not allow the cartridge assembly to fall.

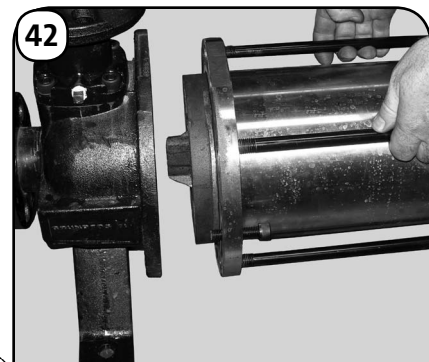

42

To remove the cartridge assembly from the Suction/Discharge Base, grab the two top staybolts and slide outward (some rocking movement may be required). **Warning:** Cartridge assemblies are heavy - a lifting device may be required.

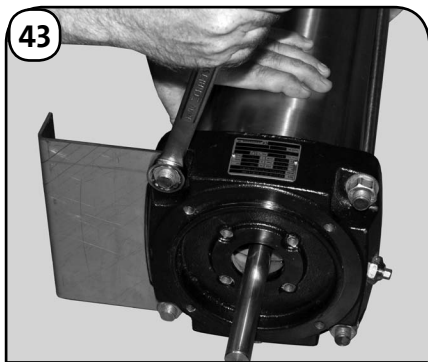

43

Move the cartridge assembly to a workbench. Lay horizontal, then finish removing the Staybolt Nuts (Pos. 36), Washers (Pos. 66a), and Support Plate (Pos. 90c). For Standard units, skip to step 53. For Cool Top®, continue with step 44.

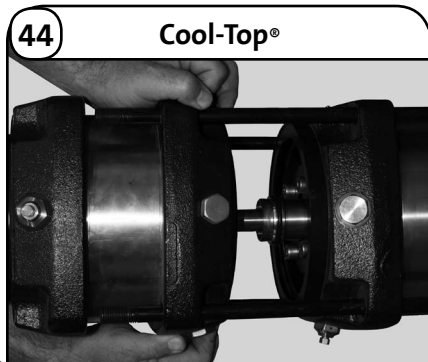

44

Cool-Top®

Remove the outermost Pump Head (Pos. 2b), Outer Sleeve (Pos. 55a) and middle Pump Head (Pos. 2c) as a complete assembly if it has not leaked, then skip to step 48. If the assembly has leaked, follow steps 45 to 47.

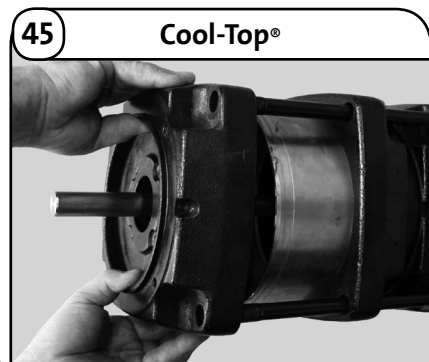

45

Cool-Top®

Remove the outermost pump head. This may require light blows with rubber mallet to the underside of the pump head.

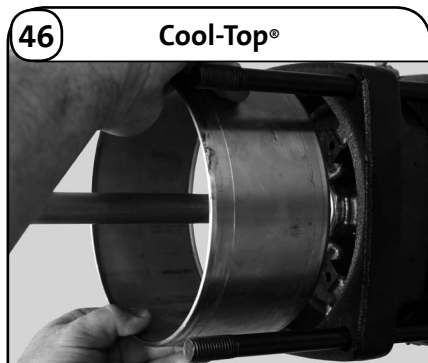

46

Cool-Top®

To remove the outer sleeve, diagonally grip the Staybolts (Pos. 26). Using your thumbs, press against the sleeve to release the sleeve from the middle pump head. If it does not move freely, light blows with a rubber mallet might be required. Once loose, slide the sleeve off.

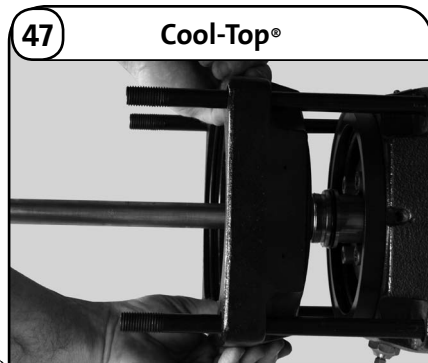

47

Cool-Top®

Slide/remove the middle pump head (Pos. 2c).

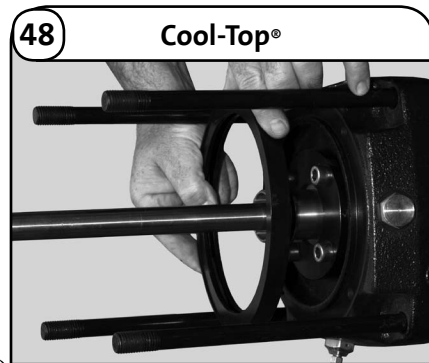

48

Cool-Top®

Remove the Spacing Ring (Pos. 116).

49 Cool-Top®

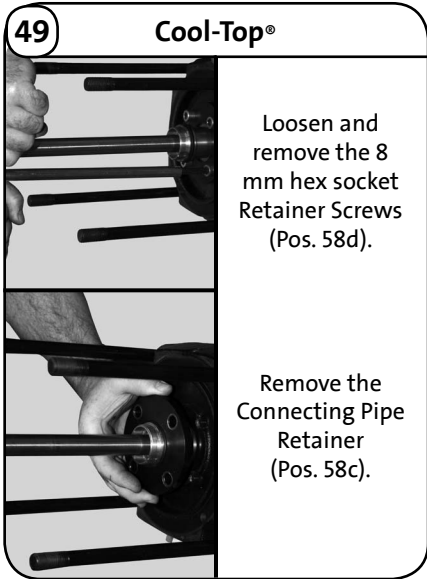

Loosen and remove the 8 mm hex socket Retainer Screws (Pos. 58d).

Remove the Connecting Pipe Retainer (Pos. 58c).

50 Cool-Top®

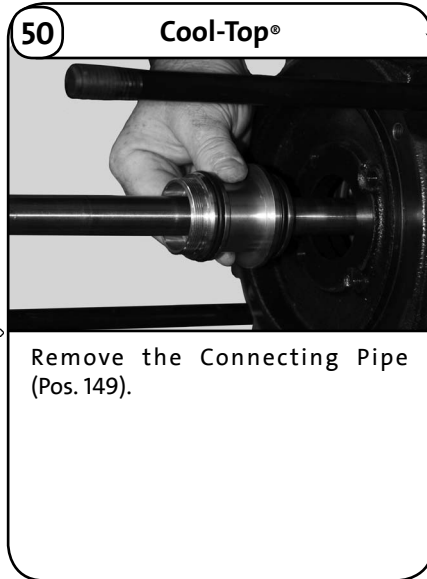

Remove the Connecting Pipe (Pos. 149).

51 Cool-Top®

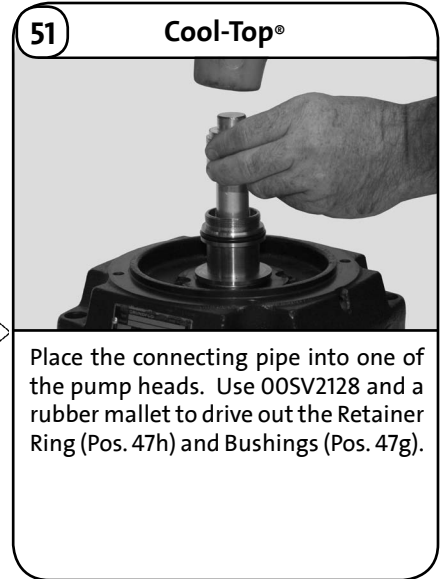

Place the connecting pipe into one of the pump heads. Use 005V2128 and a rubber mallet to drive out the Retainer Ring (Pos. 47h) and Bushings (Pos. 47g).

52 Cool-Top®

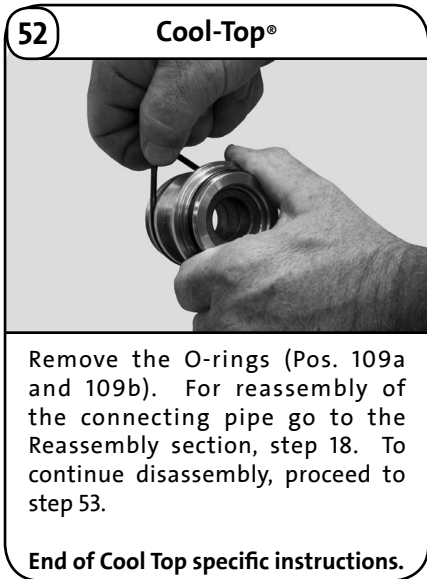

Remove the O-rings (Pos. 109a and 109b). For reassembly of the connecting pipe go to the Reassembly section, step 18. To continue disassembly, proceed to step 53.

End of Cool Top specific instructions.

53

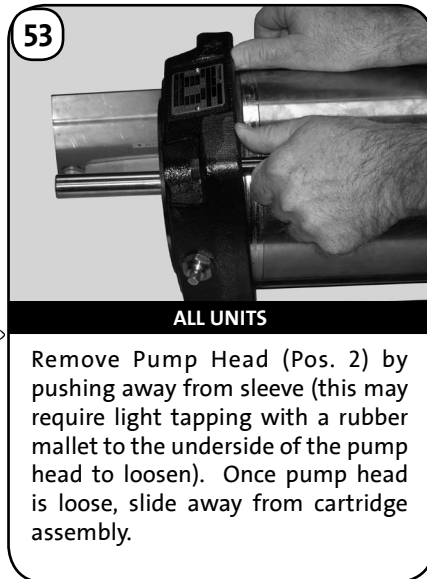

ALL UNITS

Remove Pump Head (Pos. 2) by pushing away from sleeve (this may require light tapping with a rubber mallet to the underside of the pump head to loosen). Once pump head is loose, slide away from cartridge assembly.

54



Remove the Stack (Pos. 80) from the remainder of the assembly.

For STACK dismantling, go to step 59.

55

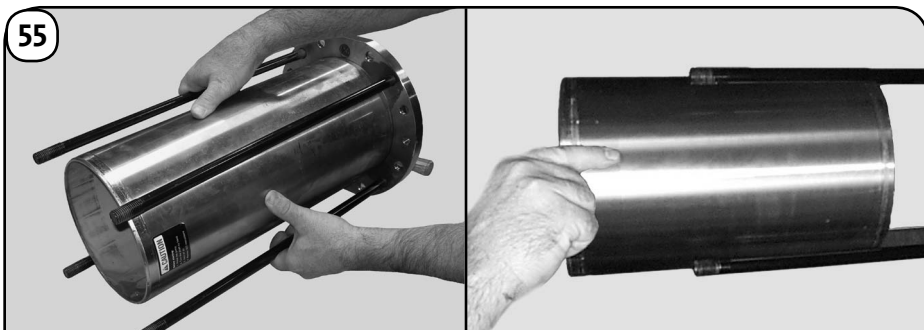

To remove outer sleeve (Pos. 55), grip staybolts diagonally. Using your thumbs, press against sleeve to release the sleeve from the sleeve flange (light blows with a rubber mallet may be required). Once the sleeve is loose, slide/remove it.

56



Using a small screwdriver, remove Sleeve O-rings (Pos. 37) from the pump head and the sleeve flange.

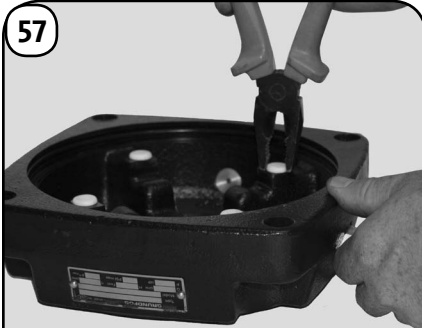

Remove the four STACK Compression Spacers (Pos. 60).

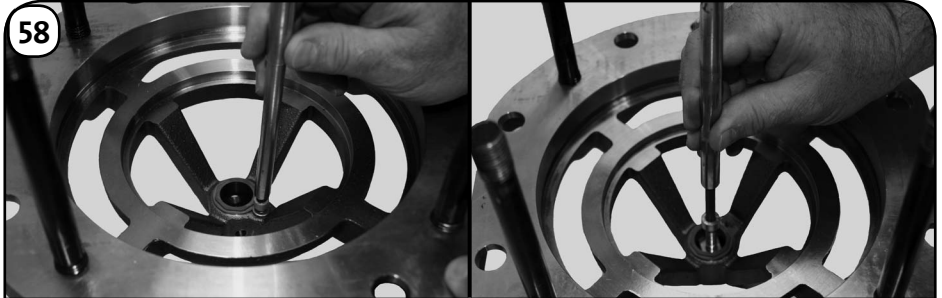

To remove the Bottom Bearing (Pos. 6g), loosen and remove the 5 mm Hex Socket Allen Screw (Pos. 31) and Washer (Pos. 32) from the Sleeve Flange (Pos. 55b). Using the Bearing Puller (00SV0002) and M8 x 50 mm Allen Screw (00ID6595), insert the bearing puller along with the allen screw at an angle until it passes through the bearing. Once the bearing puller is under the bearing's lower edge, turn the 6 mm hex socket allen screw until the bearing has been pryed out of the housing.

For STACK replacement, proceed to Reassembly, step 11. For STACK Dismantling, continue with step 59.

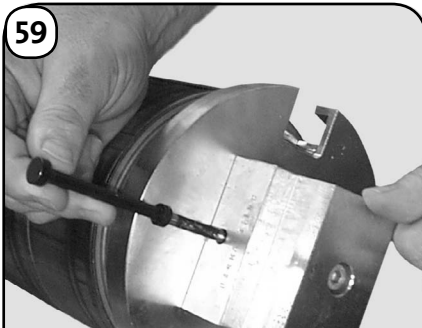

Fit assembly/disassembly tool (00SV0003) to Stack. The tool consists of different size spacing plates. Select the plate which fits securely to the Stack Interface (Pos. 44). Place holding pin into the disassembly hole.



Loosen the chamber straps, remove 6 mm hex socket Allen Screw (Pos. 26b), Washer (Pos. 26c), and Chamber Straps (Pos. 26a).



Remove the Upper Chamber (Pos. 3).



Loosen Split Cone Nut (Pos. 48) approximately two to three full turns with split cone nut wrench (00SV0004). Flip tool over and give a sharp blow directly down against the split cone nut. This will loosen the Split Cone (Pos. 49b) and allow the Impeller (Pos. 49a) to be lifted off the shaft. Lift off Chambers (Pos. 4 & 4a). Repeat this process until all impellers are removed from Shaft (Pos. 51).



Remove Base Interface (Pos. 44).

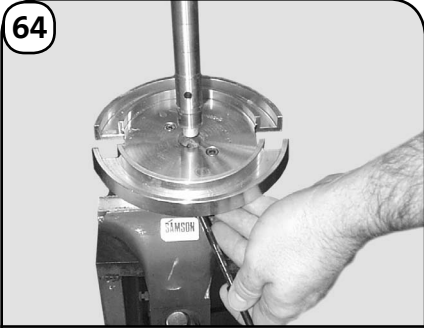

64

To remove the shaft from the assembly/disassembly tool, remove the holding pin from the shaft and lift shaft out of tool.

After inspecting the parts, if further disassembly is required, proceed to the next steps.

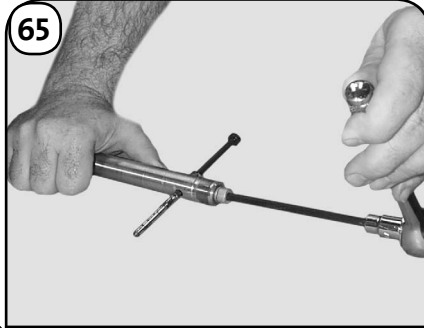

65

Remove bearing from shaft. Remove 6 mm hexsocket Allen Screw (Pos. 67), Locking Washer (Pos. 66b), Washer (Pos. 66), and Journal Bearing (Pos. 47b). Loosening the allen screw may require use of the holding pin as a countering device so the shaft does not spin.



66

Depending on wear, the Neck Ring (Pos. 45), Retainer (Pos. 65), and Holder (Pos. 45a) may need to be removed. Using a flat bar, pry these components out of the chambers and base interface as a complete assembly.



67

If wear or damage is minor, the neck ring may be replaced using a screwdriver to twist and pry out the retainer.



68

Lift out the Neck ring (Pos. 45).

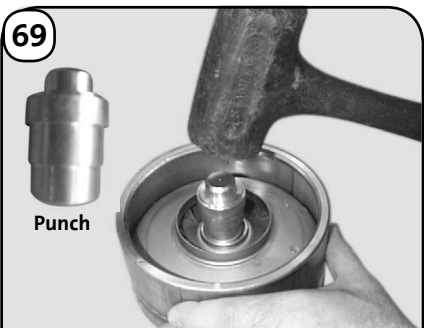

69

Punch

To remove the Chamber Bearing (Pos. 47), Bearing Sleeve (Pos. 47c), and Bearing Lock Ring (Pos. 47d), place chamber upward using the punch (00SV0015). Drive the bearing downward.

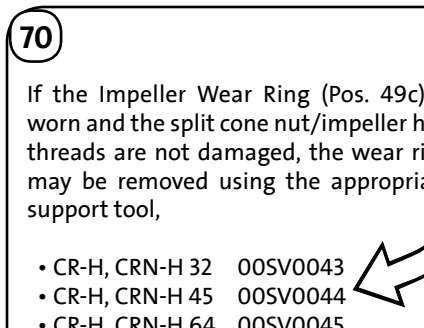

70

If the Impeller Wear Ring (Pos. 49c) is worn and the split cone nut/impeller hub threads are not damaged, the wear ring may be removed using the appropriate support tool,

- CR-H, CRN-H 32 00SV0043
- CR-H, CRN-H 45 00SV0044
- CR-H, CRN-H 64 00SV0045
- CR-H, CRN-H 90 00SV0046

along with the wear ring puller (00SV0239) used to pry off the wear ring. If the threads of the impeller hub are damaged, a new impeller will be required.

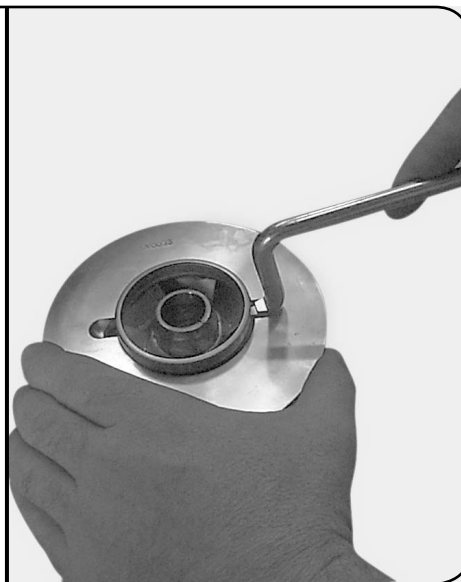

If the Discharge Adaptor Flange (12a) has leaked, the O-ring may need replacement.
To remove, follow the next steps after removing the system discharge piping.

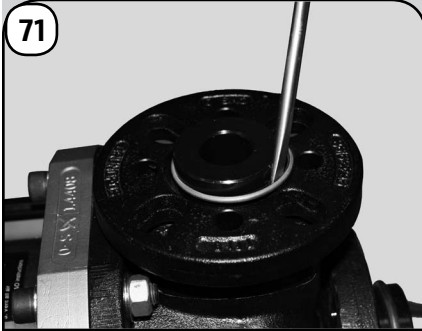

71
Push the Flange Ring (Pos. 201) down, use a screwdriver to remove the Retaining Ring (Pos. 203), then remove the flange ring.

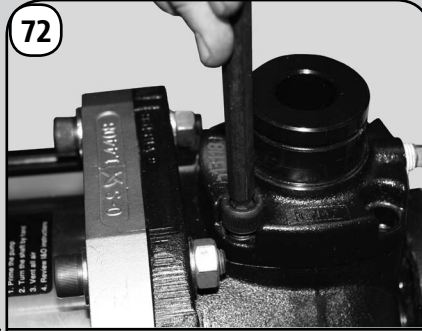









72
Remove the Flange Allen Screws (Pos. 35).

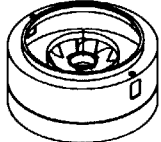

73
Remove the O-ring (Pos. 39b).

— THE PUMP IS —
NOW COMPLETELY
DISASSEMBLED.

When Should A Part Be Replaced?

| Part | Position(s) | Minimum Operating Condition | |
|---------------------------|------------------|--|---|
| Pump Head | 2 | Excessive pitting of these castings could cause leaks. Rusted castings should have all seating areas cleaned to ensure proper seating of O-rings. |  |
| Suction/Discharge Base | 6 | | |
| Chambers | 3, 4a, 4 | Same as for impellers. | |
| O-rings | 37, 38, 38a, 100 | Should be soft and pliable with no visible scars. Since they are easily damaged and fairly inexpensive, it is recommended they be replaced whenever the pump is disassembled. |  |
| Neck Ring | 45 | Should be free of visible wear on the inside edges. Inside diameter for: CR-H, CRN-H 32 = 66.2 mm CR-H, CRN-H 45 = 73.9 mm CR-H, CRN-H 64 = 86.3 mm CR-H, CRN-H 90 = 93.8 mm |  |
| Bearing Ring | 47a | The diameter size difference between the Bearing Ring (Pos. 47a) and the Bearing (47) fixed inside the intermediate chambers should be no greater than 0.4 mm. |  |
| Bushing and Bearings | 6g, 47, 47b, 47c | Wear to the inner surface on the chamber bushings (Pos. 47c) fixed inside the intermediate chambers should be no greater than 0.6 mm. The wear to the bottom bearings, Pos. 6g and 47b, should be no greater than .4 mm. |  |
| Impellers | 49 (a, d, e & i) | Should be free from physical markings except for the guide vane welds. Any additional indentations may result from: (1) Cavitation - the implosion of vapor "bubbles" within the impeller stack. Make sure the Net Positive Suction Head Available for the pump meets the minimum Net Positive Suction Head Required for the pump when running at the required flow. (2) Improper coupling height - If the coupling is not set to the proper height (see Reassembly procedures: Back-to-Back, steps 43, 74 to 80; Standard & Cool Top, steps 74 to 80; Tandem/Flush Seal, steps 56, 72, 73 78 to 80) the impellers are not suspended as they should be, but instead they rub against the chambers, either above or below, causing contact wear. (3) Worn groove to Impeller Wear Ring (Pos. 49c) from system sediments. Wear rings should be replaced, or impeller complete if threaded area for split cone nut is damaged. |  |
| Shaft | 51 | Should show no signs of gouging or wear throughout its total length. If reusing the shaft, use a light grit emery cloth to smooth away sharp edges made by the shaft seal set screws. |  |
| Stack Compression Spacer | 60 | Should always be replaced. | |
| Shaft Seal Cartridge Cpl. | 105 (a, b & c) | Should seal without leakage |  |

Refer to the Parts List and Kits section for a list of material numbers and spare part kits.

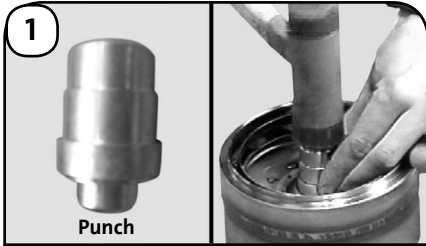

1

Punch

To reinstall the Chamber Bearing Ring (Pos. 47), or Bearing Sleeve (Pos. 47c), and Bearing Lock Ring (Pos. 47d or 47e), place the chamber in a downward position. Depending on the type of Chamber used (Pos. 3, 4a, or 4), place the appropriate components (Pos. 47 or 47c) and (Pos. 47d or 47e) onto the chamber. Position the reduced diameter end of the punch through the components. Use a rubber mallet to drive in place.



2

To reinstall the Neck Ring (Pos. 45), the Neck Ring Retainer (Pos. 65), or complete Neck Ring Assembly (Pos. 45a), place these components into the Chamber (Pos. 4 or 4a) or Base Interface (Pos. 44). Position the appropriate neck ring punch

- CR-H, CRN-H 32 00SV0025
- CR-H, CRN-H 45 00SV0027
- CR-H, CRN-H 64 00SV0028
- CR-H, CRN-H 90 00SV0029

onto the components to be inserted into the chamber or base interface. Using a rubber mallet, drive these components firmly in place.



3

Before reusing the Shaft (Pos. 51), use an emery tool to smooth away shaft seal set screw marks and make sure the main shaft area is not worn. If the Journal Bearing (Pos. 47b) was removed, replace the journal bearing. Add the Clamping Washer (Pos. 66), and two Locking Washers (Pos. 66b). Loosely thread the 6mm Allen Screw (Pos. 67) onto the shaft. To ensure journal bearing and clamp washer alignment, slide the Bottom Bearing (Pos. 6g) over these items. Place the holding pin through the shaft to prevent it from spinning while the allen screw is tightened to a torque of 23 ft.-lbs./31Nm. Remove the hold pin and the bottom bearing 6g after torque value is achieved.



4

Fit the shaft into the assembly/disassembly fixture (00SV0003). Make sure the holding pin is inserted into the assembly hole. Refer to the diagrams on pages 27-30 for the appropriate staging sequence.



5

Fit the Base Interface Assembly (Pos. 44 or 44a) onto the assembly/disassembly fixture. Be sure to use the appropriate spacing plate that fits snugly to the bottom of the base interface. Using the incorrect spacing plate can lead to rotation and end play* problems.

* End play is shaft travel (up and down) through the chambers.

6

After pressing on a new Wear Ring (Pos. 49c), or if using a new Impeller (Pos. 49d, e, or i), place the complete impeller over the shaft and seat into the interface assembly. Slide the Split Cone (Pos. 49b) down the shaft and into the recessed area of the impeller hub. Use the split cone nut tool (00SV0004) in the inverted direction and firmly drive split cone into the impeller. While performing this function, care must be taken to avoid damaging the threaded hub area of the impeller.

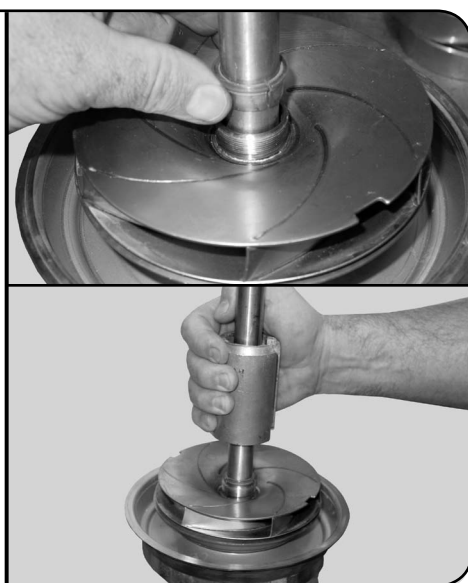

7

Place Gardolube (00SV9995) or equivalent FDA approved non-toxic lubricant on the threaded area of the hub. Thread the Split Cone Nut (Pos. 48) onto the impeller. Using the split cone nut tool (00SV0004), Adapter (00SV0403), and Torque Wrench (00SV0269), torque the split cone nut to 52 ft.-lbs./70 Nm.

8

Refer to the diagrams on pages 27-30 for the appropriate staging sequence for your particular model pump. Once the last chamber has been installed, continue with step 9.

9



Hook the Chamber Straps (Pos. 26a) through the Base Interface (Pos. 44). Position top end of straps into relieved area of the Top Chamber (Pos. 3). Place the Washer (Pos. 26c) and 6 mm hex socket Allen Screws (Pos. 26b) loosely threaded into the straps. Allen screws must be pre-lubricated with Gardolube. Torque evenly to 11 ft.-lbs./15 Nm.

10

Remove the holding pin from the assembly/dismantling fixture. Lift the STACK® (Pos. 80) out of the fixture. Lay the stack on a flat surface and check the rotation and end play*. Movement should be free and without binding.

* End play is shaft travel (up and down) through the chambers.

11

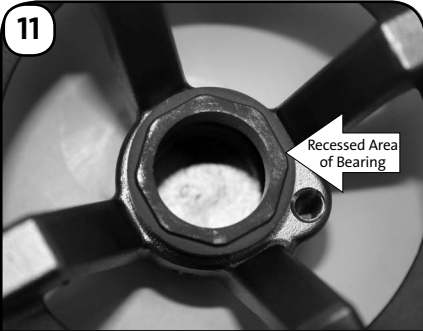

Recessed Area of Bearing

To install the Bottom Bearing (Pos. 6g) into the Sleeve Flange (Pos. 55b), place the bearing into the hole provided in the flange. Ensure the recessed area of the bearing is located where the hole for the allen screw is machined in the flange.

12



Use the Bearing Punch (00SV0015) and a rubber mallet to gently drive the bearing into place.

13

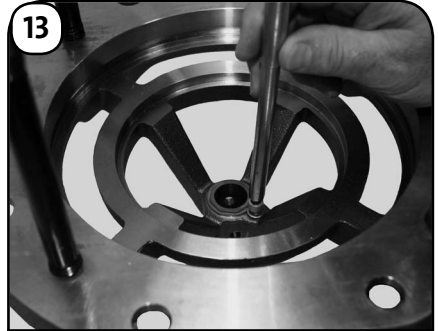

Place the Washer (Pos. 32) and 5 mm hex socket Allen Screw (Pos. 31) into the suction/discharge base. Tighten down against the bearing to hold in place. Torque to 6 ft.-lbs./8 Nm.

14



Use the appropriate sleeve flange O-ring material for the application. Standard units: EPDM or FKM (Pos.37). Exotic and/or fluid with temperatures over 250° F, use FXM or FFKM (Pos.37a). Place the sleeve o-rings into the recessed groove in the Pump Head (Pos.2, 2b & 2c) and the sleeve flange. In Cool Top® equipped pumps, the lower hot section of the pump (pump head [Pos.2] and the sleeve flange) should have FXM or FFKM o-rings. For all material types: never use oil or grease on the o-rings; lubricate the o-rings with Rocol (00RM2924) or Dow Corning 111.

15



Place the STACK® Assembly (Pos. 80) into the sleeve flange. Rotate straps so they are centered between the Staybolts (Pos. 26). Support blocks (like 2x4 material) may need to be used under the sleeve flange to prevent toppling.

16



Place Sleeve (Pos. 55) into the sleeve flange. Line up venting sticker with flat surface of sleeve flange. This will ensure the lubrication hole is pointed downward when assembled. Press sleeve firmly in place. This may require gentle taps with a rubber mallet.

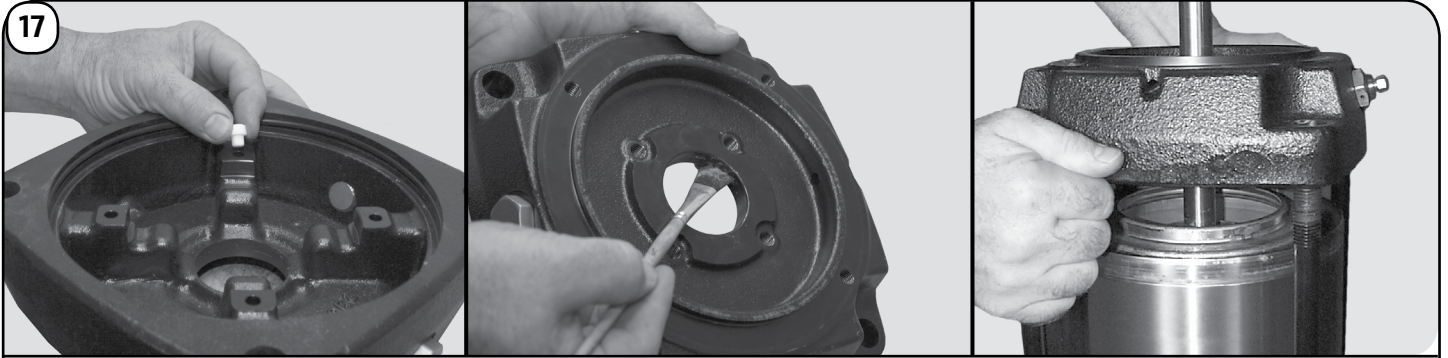

17 Replace the four PTFE Stack Compression Spacers (Pos. 60) into the Pump Head (Pos. 2) which will seat against the stack. Lubricate the inner bore of the pump head, or all pump heads for Cool Top® or Back-to-Back seal equipped pumps, with Rocol (OORM 2924) or Dow Corning 111. For Standard, Cool Top® and Tandem equipped pumps, position and lower the completed pump head over the Staybolts (Pos. 26). Make sure the vent plug (Pos. 18) is located in line with the vent sticker and the flat surface of the sleeve flange. Use a rubber mallet to firmly seat the pump head.

For Standard and Tandem equipped seal pumps, skip to reassembly step 46.
For Cool Top® units, continue with Reassembly steps 18 to 24.

Cool-Top®

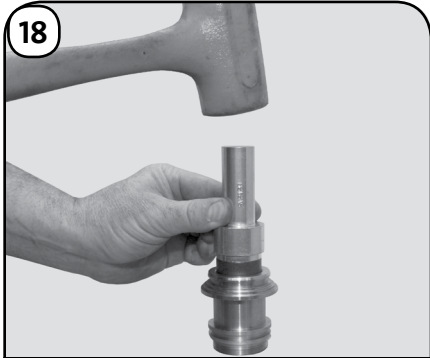

18

Use 00SV2128 and a rubber mallet to drive in three new Bushings (Pos. 47g) and the Retainer Ring (Pos. 47h) into the Connecting Pipe (Pos. 149).

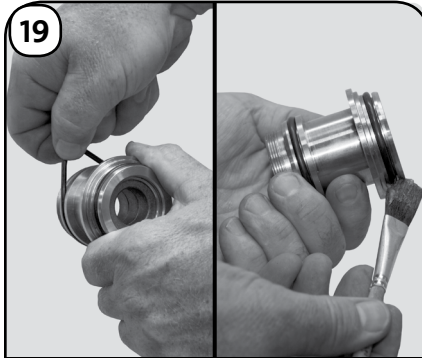

19

Replace the O-rings (Pos. 109a & 109b). Do not roll the O-ring into place; stretch and release them into the grooves. Then lubricate the O-rings with Rocol or Dow Corning 111.

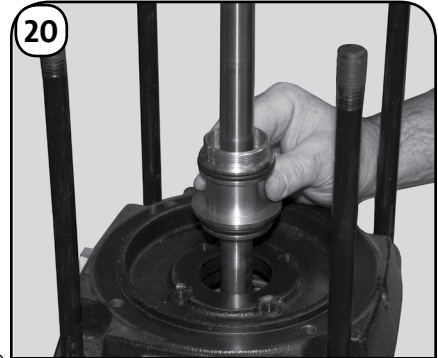

20

Slide the completed connecting pipe assembly down over the shaft and firmly seat it into the lowermost Pump Head (Pos. 2).

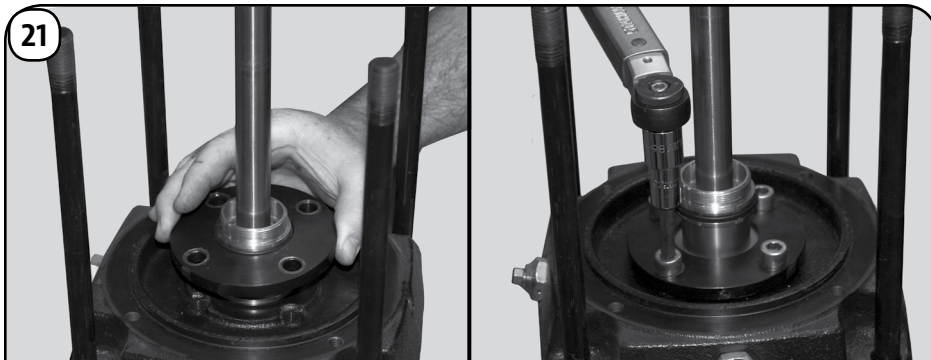

21

Lower and seat the Retainer (Pos. 58c) for the connecting pipe. Lubricate the threads of the 8 mm hex socket Retaining Screws (Pos. 58d) with Gardolube (00SV9995) or Thread-Eze (96611372). Install and diagonally torque the screws to 46ft.-lbs./62Nm.



22

Place the Spacing Ring (Pos. 116) onto the pump head.

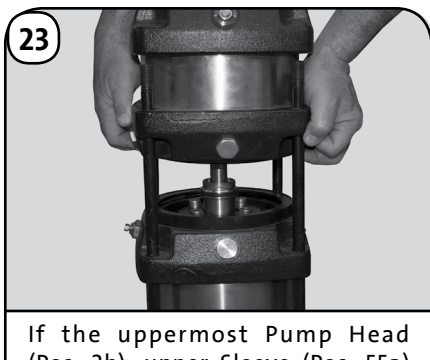

23

If the uppermost Pump Head (Pos. 2b), upper Sleeve (Pos. 55a) and middle Pump Head (Pos. 2c) did not leak and were removed as a complete assembly, then lower it back in place as a complete assembly and skip to reassembly step 46. If the assembly leaked and was fully dismantled, continue with step 24.

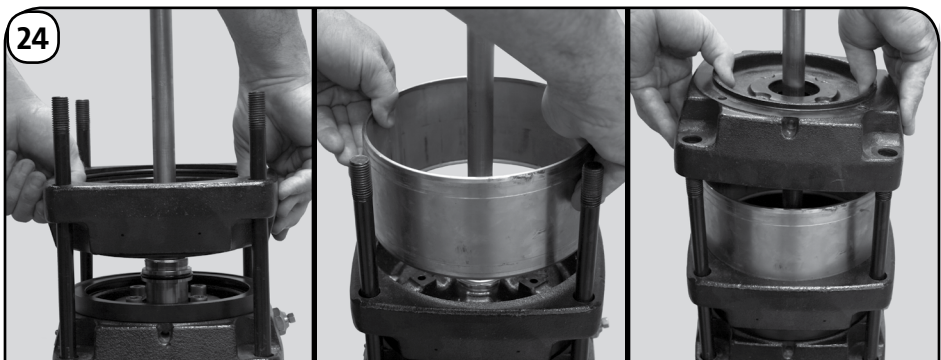

24

O-rings of EPDM or FKM should have already been installed into the pump heads as noted in Reassembly, step 14. If they were not, install them now. Then, lower the middle pump head and carefully press it over the connecting pipe O-ring and seat it on the spacing ring. Install the upper sleeve, and firmly press it in place. Put the uppermost pump head in place, making sure it is firmly seated. Skip to reassembly step 46.

Back-to-Back Seal

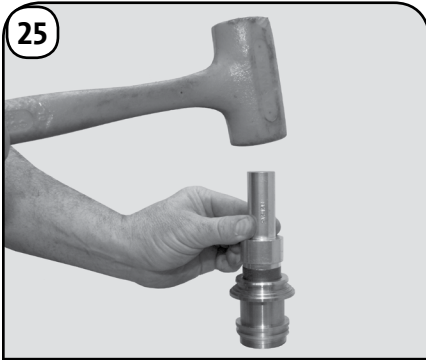

25
Use 00SV2128 and a rubber mallet to drive in three new Bushings (Pos. 47g) and the Retainer Ring (Pos. 47h) into the Connecting Pipe (Pos. 149).

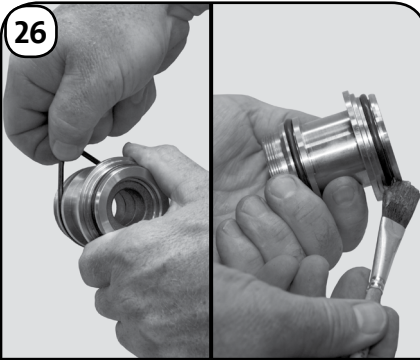

26
Replace the O-rings (Pos. 109a & 109b). Do not roll the O-ring into place; stretch and release them into the grooves. Then lubricate the O-rings with Rocol or Dow Corning 111.



27
Place and fully seat the complete connecting pipe assembly into the lowermost Pump Head (Pos. 2), which has the PTFE stack compression spacers.

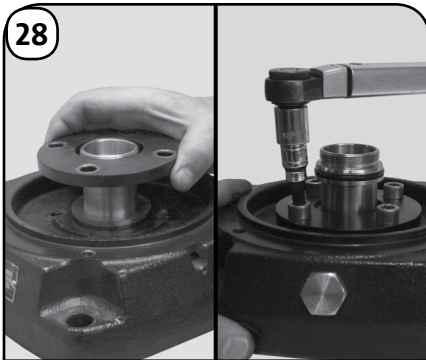

28
Lower the Retainer (Pos. 58c) over the connecting pipe. Lubricate the threads of the 8mm hex socket Retaining Screws (Pos. 58d) with Gardolube (00SV9995) or Thread-Eze (96611372). Install and diagonally torque to 46ft.-lbs./62Nm.



29
Place the Spacing Ring (Pos. 116) onto the pump head.

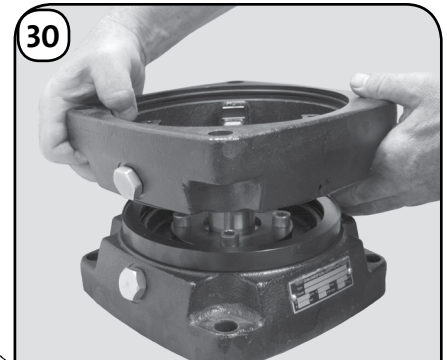

30
Lower the middle Pump Head (Pos. 2c) over and past the connecting pipe threads and upper O-ring. The pump head should rest on top of the spacing ring.

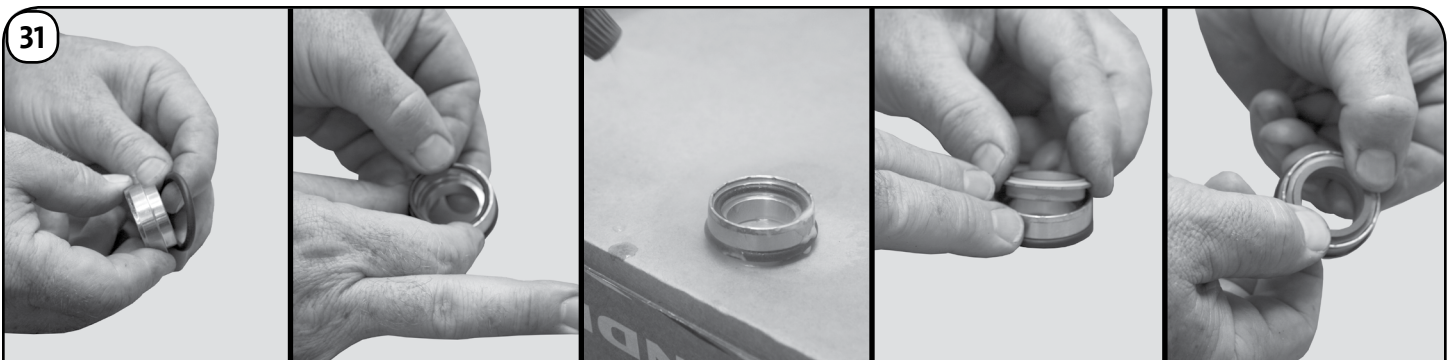

31
Assemble the stationary seal by placing the O-ring (Pos. 102) over the Retainer (Pos. 103a). Place the O-ring (Pos. 102a) into the retainer recess. Lubricate/spray a 5% solution of soapy water onto the O-ring resting in the retainer recess. Align edges of the Stationary Seal (Pos. 103) with the retainer and firmly press the stationary seal into O-ring. Stationary seal components can be seen in the diagram on the next page.

Back-to-Back Seal (continued)

COMPONENTS OF STATIONARY SEAL

"N" PUMPS AND MODEL B

Side View

Pos. 103 Upper Seal Ring

Pos. 102a O-Ring

Pos. 103a Retainer For Upper Seal Ring

Side View

Pos. 102 O-Ring

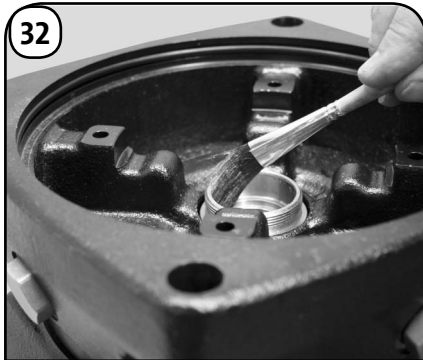

32 Lubricate the inner surface of the connecting pipe with Rocol, Dow Corning111, or soapy water. Lubricate the threads with Gardolube or an equivalent FDA approved non-toxic lubricant.

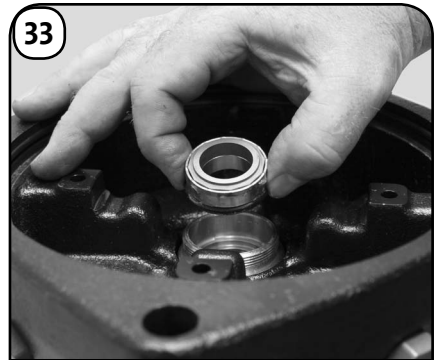

33 Lower and press the completed stationary seal assembly into the connecting pipe.

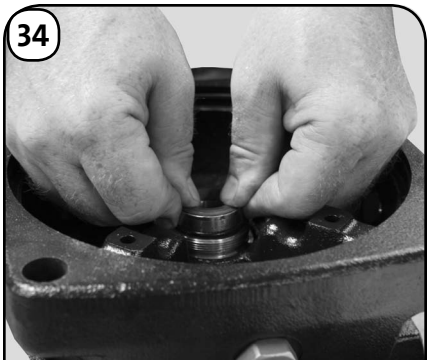

34 Press the stationary seal assembly into the connecting pipe. Clean the polished seal face surface with an alcohol wipe.

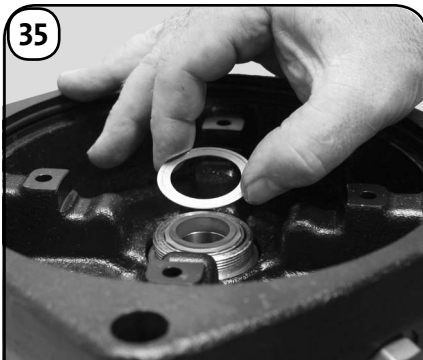

35 Place the Retaining Washer (Pos. 59a) onto the seal.



36 Loosely thread the Securing Nut (Pos. 148) onto the connecting pipe.



37 Use special tool 00SV7902 to tighten the nut. The underlined text for steps 38 to 45 depends if the unit is still attached horizontally in the system or is standing vertical as a cartridge assembly. If vertical, lower; if horizontal, slide.



38 When reusing an existing shaft, first clean any set screw marks off the shaft with a light grit emery cloth. Next, lift the complete assembly (lowermost pump head, spacing ring, middle pump head, and complete stationary seal) by the lowermost pump head. Position the Priming Vent Plug (Pos. 18) on the lowermost pump head so it is pointing upward or is in line with the venting label and flat surface of the sleeve flange. Carefully lower the assembly down the shaft and staybolts. Firmly seat the assembly in place onto the sleeve.

The order of assembly for the rotating portion of the seal can be seen on the next page.

To prevent leakage, it is critical to position the rotating seal face correctly.

Back-to-Back Seal (continued)

COMPONENTS OF ROTATING SEAL

LOWER COMPONENTS OF SEAL ASSEMBLY

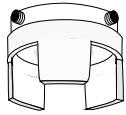

Pos. 112
Seal Driver with set screws, Pos. 113



Pos. 108
Spring



Pos. 106
Cup for O-ring and Spring



Pos. 107
O-Ring

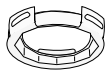

Pos. 111
Floating Seal Driver



Pos. 104
Rotating Seal Face
(The tapered face should point outward/upward through the driver 111 and press against the O-ring 107).

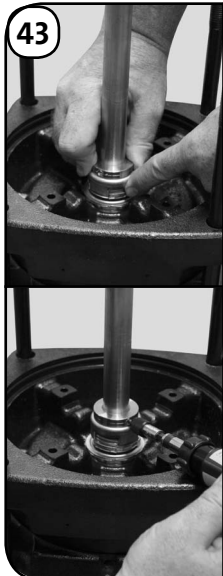
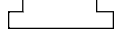

43 Slide/lower the Driver (Pos. 112) with set screws (Pos. 113). Driving tabs should pass and engage each other. With the shaft and the seal drivers pushed down/inward as far as possible, tighten the 3mm Set Screws (Pos. 113) to 10ft.-lbs./13Nm.

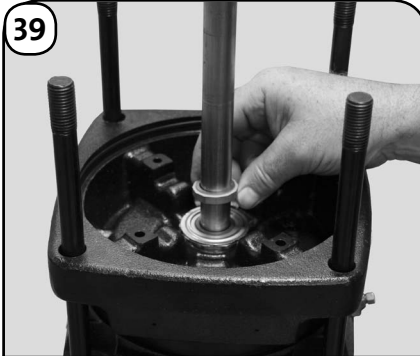

39 With the tapered edge facing upward/outward, slide/lower the Rotating Seal Face (Pos. 104) down onto the stationary seal face.
Note:
Upward, if vertical
Outward, if horizontal

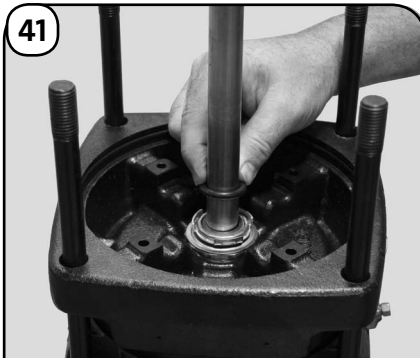

41 Lubricate the inner surface of the O-ring (Pos. 107) with Rocol, Dow Corning 111, or soapy water. Slide the O-ring down the shaft until it contacts both the driver and the protruding surface of rotating seal face.

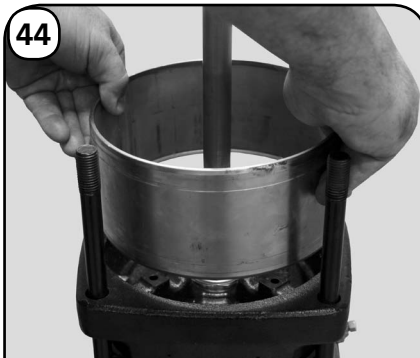

44 Slide/lower and seat the upper Sleeve (Pos. 55a) into the middle pump head.

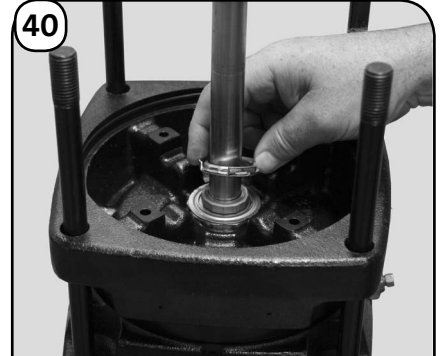

40 Slide/lower the Floating Seal Driver (Pos. 111) until it fully engages the rotating seal face. Ensure the taper of the rotating seal protrudes through driver.

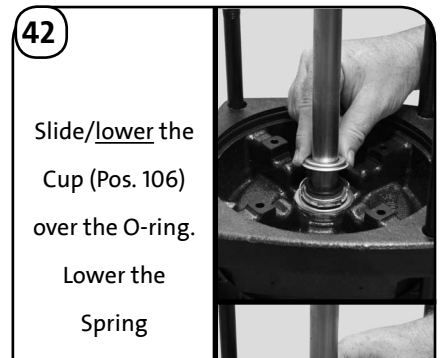

42 Slide/lower the Cup (Pos. 106) over the O-ring. Lower the Spring (Pos. 108) until it fits over the cup.

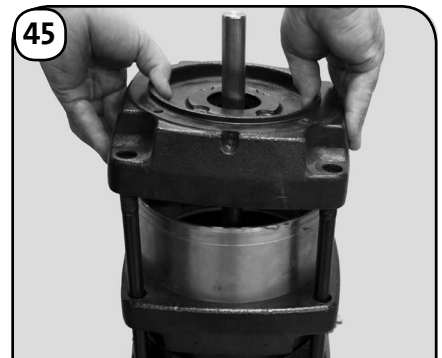

45 Slide/lower and firmly seat the uppermost/outermost Pump Head (Pos. 2b) onto the upper sleeve. Proceed to step 46.

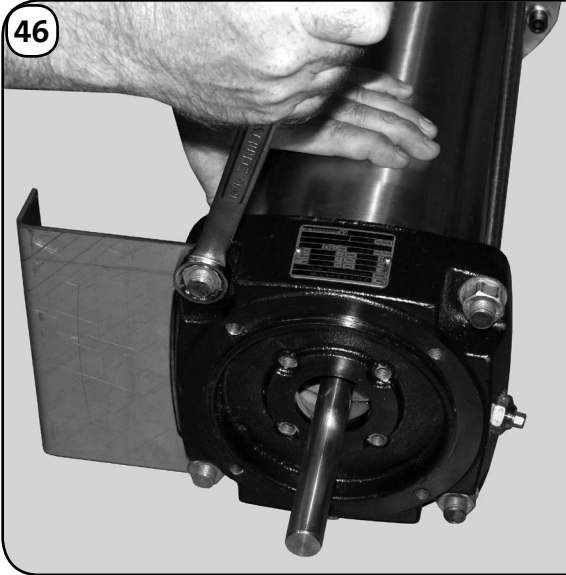

Opposite the vent plug, place the Cartridge Support Foot (Pos. 90c) over the staybolts. The angle should be facing downward toward the sleeve flange. Place the Washers (Pos. 66a) over the staybolts opposite the support foot. Lubricate the threads on all of the staybolts with Gardolube or Thread-Eze. Loosely tighten the Staybolts Nuts (Pos. 36) do not torque at this time, this will be done in step 52. The Cartridge Assembly (Pos. 80a) is now ready to take back to where the Suction Discharge Base (Pos. 6) is located.



If the old O-ring (Pos. 72a) was not removed earlier, remove now and clean the groove in Suction/Discharge Base (Pos. 6). Next, in four equal spaced areas, place a liberal amount of Dow Corning 111 or Rocol into the groove. Fit the new O-ring into the groove, ensuring it is fully seated and does not move out of position.

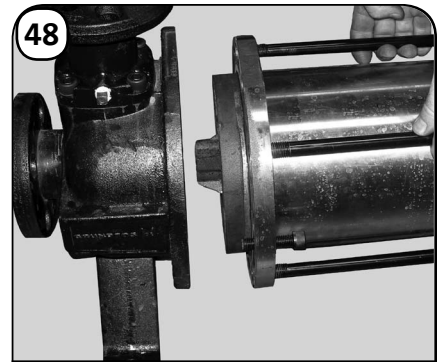

Align the cartridge and slide it into the suction/discharge base, making sure that the O-ring from step 47 is still in place. Also, make sure the sleeve flange flat surface, venting label, and vent plug are facing upward.

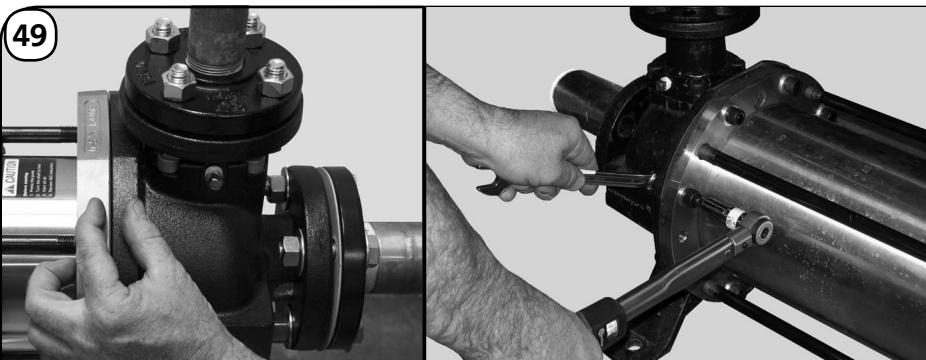

Before installing the Screws (Pos. 56c), Washers (Pos. 56d), and Nuts (Pos. 56e) into the Sleeve Flange (Pos. 55b) ensure the flange is fully seated; there should not be any gap between the flange and the suction discharge base. If there is a gap, either the o-ring from step 47 has moved out of place and is pinched, or the flange is not properly engaged into the machined recess/register in the base (see diagram at the right). Repair before proceeding. If properly seated, apply Gardolube or Thread-eze to the screws, then torque diagonally as follows: CR-H 32: 55 ft.-lbs. / 75 Nm • CR-H 45/64/90: 74 ft.-lbs. / 100 Nm

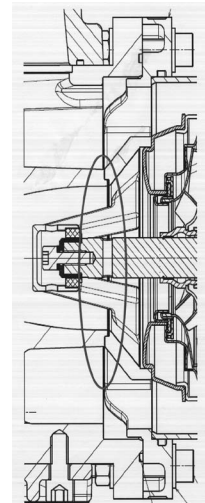



50

If the motor was removed during disassembly, reattach the motor. Lubricate the threads of the Motor Bolts (Pos. 28a) and then tighten the bolts diagonally to:

30 ft.-lbs./41 Nm for 1/2" x 13 UNC, 3-40 HP
59 ft.-lbs./80 Nm for 5/8" x 11 UNC, 50-60 HP

Slide the motor and Motor Stool (Pos. 1a) assembly down to the Pump Head (Pos. 2). Slightly lifting the cartridge may be required to allow the motor stool register to fully seat to the pump head.

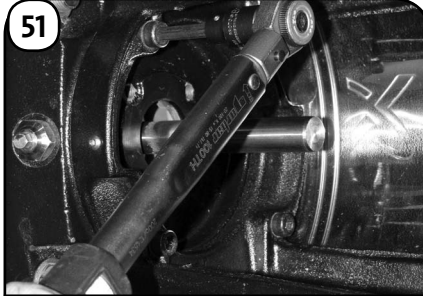

51

Lubricate the threads on the 8 mm hex socket Retaining Screws (Pos. 28) with Gardolube or Thread-Eze. Install and hand-tighten all four Allen Screws connecting the motor stool to pump head. If the holes do not line up, grab and twist the cartridge by the staybolts, then diagonally torque the allen screws to 46 ft.-lbs./62 Nm.

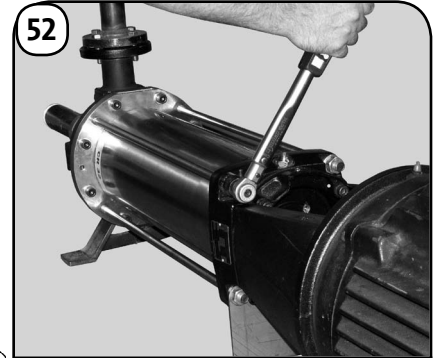

52

Torque the Staybolt Nuts diagonally to 74 ft.-lbs./100 Nm.

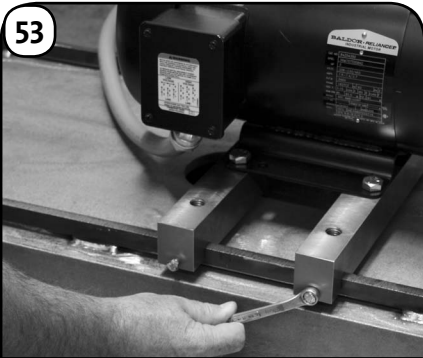

53

Tighten the Slide Rail Screws (Pos. 90d) connecting the motor to the base plate.

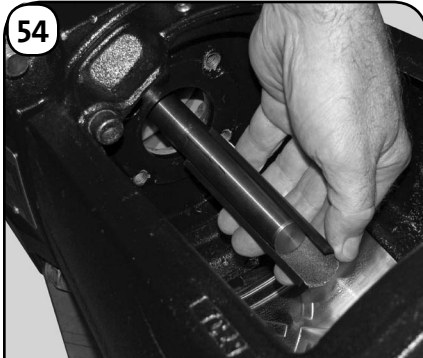

54

When reusing an existing shaft, if the shaft has not already been cleaned, first clean away any set screw marks off of the shaft with a light grit emery cloth. Then, wipe away dust before proceeding to the next step.



55

Lubricate the inner surface of the lower O-ring of the Shaft Seal (Pos. 105) with Rocol, Dow Corning 111, or soapy water. Slide the seal down the shaft by pushing against the drive collar of the seal. Seat the seal firmly in place. For Tandem Seal equipped pump only, continue with step 56. All other pump types: Standard, Cool top, and Back-to-Back units, skip to step 74.

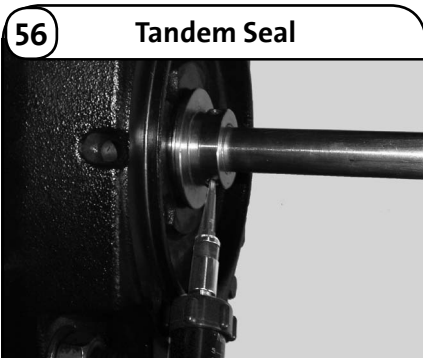

56 Tandem Seal

Push the shaft all the way in, then evenly tighten and torque the three 3 mm set screws to 6 ft.-lbs./8 Nm.

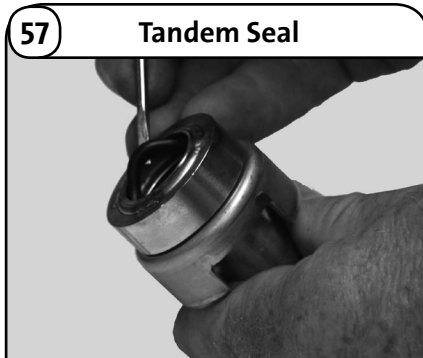

57 Tandem Seal

From the Seal Kit, install the desired EPDM or FKM O-ring (Pos. 110b) into the groove at the bottom of the seal driver with sleeve (Pos. 112).

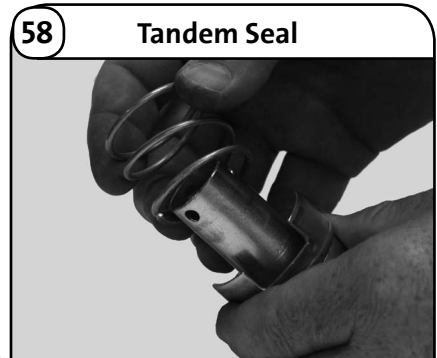

58 Tandem Seal

Slide the Spring (Pos. 108) over the sleeve.

Tandem Seal



59 Fit the cup for O-ring and Spring (Pos. 106) onto the spring.



60 Select the desired EPDM or FKM O-ring (Pos. 107) and slide it down the seal driver sleeve until it is seated into the cup.



61 Fit the floating driver (Pos. 111) onto the O-ring. Make sure the tabs are facing downward and then engage with the tags of lower driver.

Complete 105c Tandem Seal Assembly Exploded View

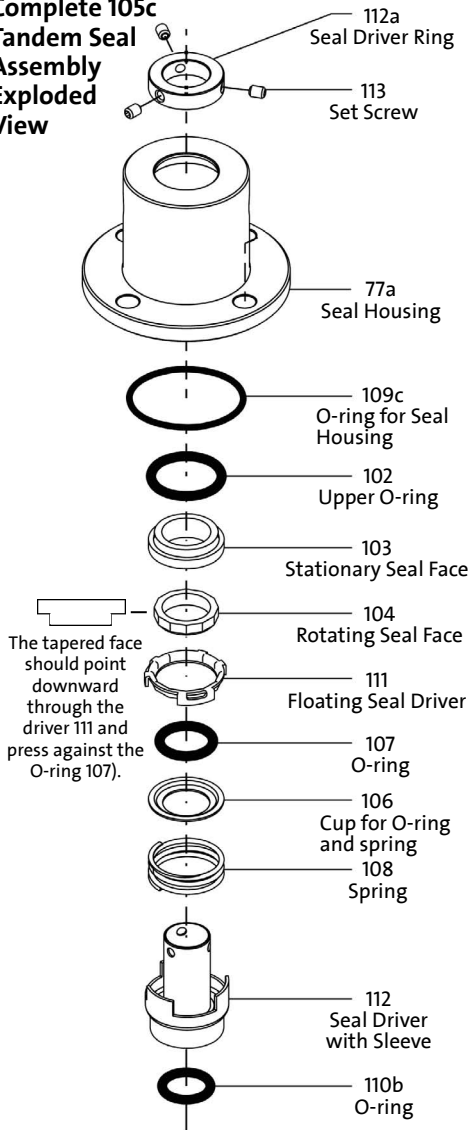

In the Exploded View, the order of assembly for the rotating portion of the seal can be seen.

To prevent leakage, it is critical to position the rotating Seal Face (Pos. 104) correctly.



62 With the tapered face pointing downward, install the Rotating Seal (Pos. 104). Tapered face should pass through the driver 111 and should press against the O-ring (Pos. 107).



63 If it was not already done, remove the Stationary Seal (Pos. 103) and O-ring (Pos. 102). Use Punch, 00SV0015, and a rubber mallet.

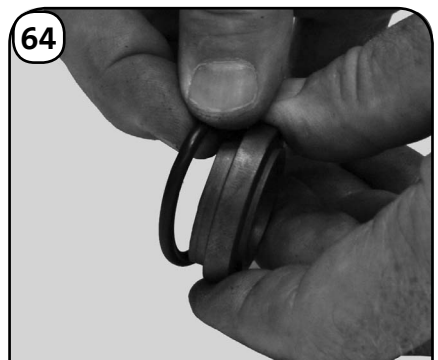

64 Place the desired EPDM or FKM O-ring (Pos. 102) onto the new Stationary Seal (Pos. 103).

Tandem Seal (continued)

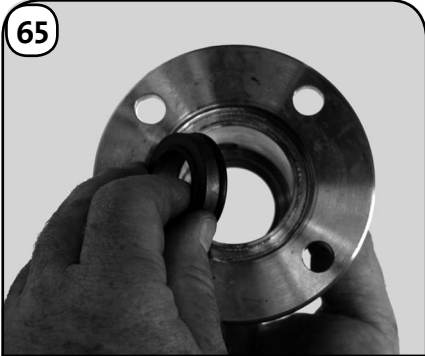

65
Spray soapy water onto the o-ring and seal the insert. Fully seat these items into the Tandem Seal Housing (Pos. 77a). Clean the polished surface with an alcohol wipe/swab.



66
Place the rotating seal assembly onto Punch00SV0015. Before lowering the tandem/flush seal housing, make sure the tabs of the drivers are positioned correct/engage each other.

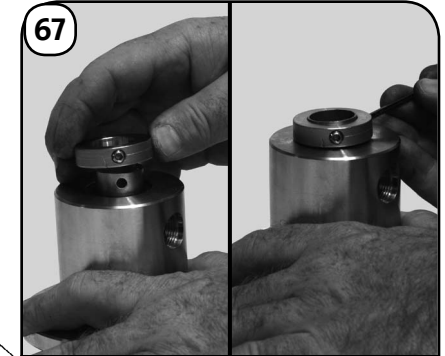

67
Hold this housing down. (If the set screw holes are not fully accessible, remove the housing and reposition the driver tabs.) Install the Seal Driver Ring (Pos. 112a). Turn the 3 mm set screws until they just engage through the sleeve.

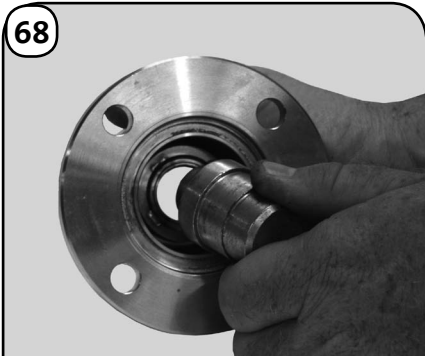

68
Turn the Tandem/Flush Seal Assembly (Pos. 105c) over and remove the Punch, 00SV0015.

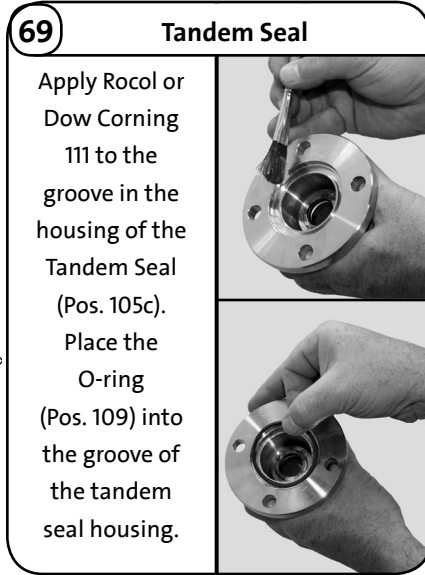

69 Tandem Seal
Apply Rocol or Dow Corning 111 to the groove in the housing of the Tandem Seal (Pos. 105c). Place the O-ring (Pos. 109) into the groove of the tandem seal housing.

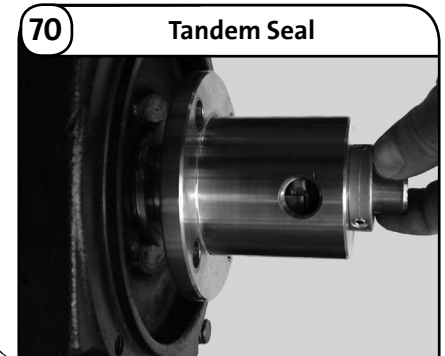

70 Tandem Seal
Pushing against the drive collar, slide the tandem seal assembly down the shaft until it stops against the lower shaft seal.



71 Tandem Seal
Lubricate the threads of the 8 mm hex socket Retaining Screws (Pos. 58d) with Gardolube or Thread-Eze. Install and diagonally torque to 46 ft.-lbs./62 Nm.

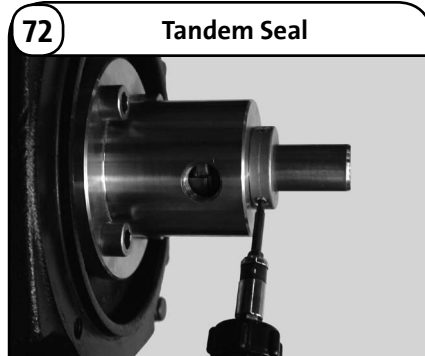

72 Tandem Seal
Push down/inward on the shaft and evenly tighten. Then, torque the three 3 mm set screws to 6 ft.-lbs./8 Nm.

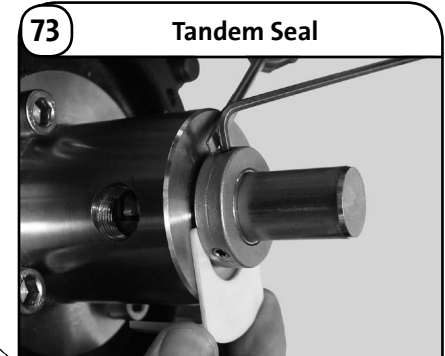

73 Tandem Seal
Pull the shaft outward and place the Adjust Fork/Spacing Tool, 985924, between the housing and seal driver ring.
Tandem Seal continues with step 78.

Standard, Cool Top® & Back-to-Back Seal Units

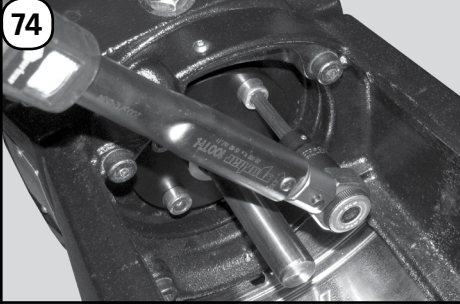

74 Lower and seat the Retainer (Pos. 58). Lubricate the threads of the 8 mm hex socket Retaining Screws (Pos. 58a) with Gardolube or Thread-Eze. Install and diagonally torque the screws to 46ft.-lbs./62Nm.

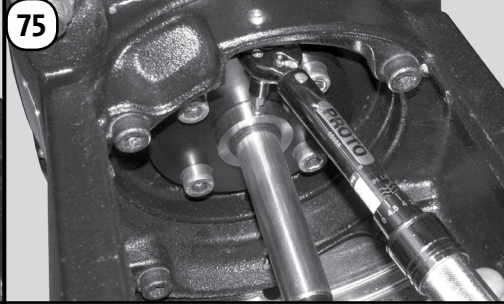

75 Push the shaft inward (for Back-to-Back units, continue inward pressure as the inboard seal spring tension may push the shaft out). Evenly tighten, then torque the three 3 mm set screws to 6 ft.-lbs./8Nm.

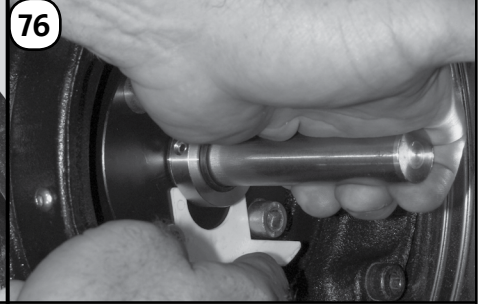

76 Pull the shaft outward and insert the adjusting fork under the seal collar.

77 Standard, Cool Top® & Back-to-Back Seal Units

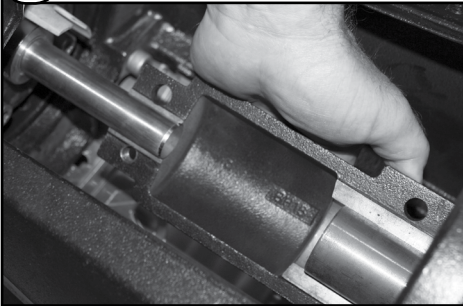

To install the Coupling Halves (Pos. 10a), position the coupling half relief area flushed with the top of the shaft as shown in the diagram. Lubricate the threads on the 8 mm hex socket Coupling Screws (Pos. 9) with Gardolube or Thread-Eze. Loosely thread the screws in place.

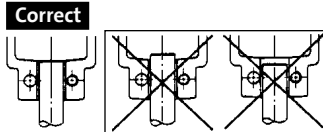
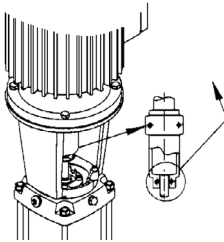

78 Tandem Seal Only

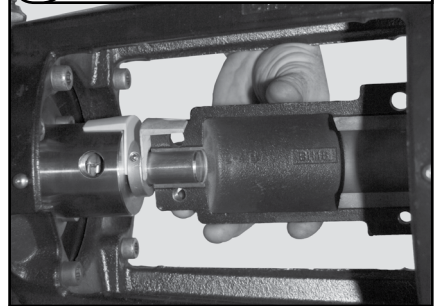

Place a second adjusting fork on top of the seal collar. Install the Coupling Halves (Pos. 10a). Lubricate the threads on the 8 mm hex socket Coupling Screws (Pos. 9) with Gardolube or Thread-Eze. Loosely thread the screws in place.

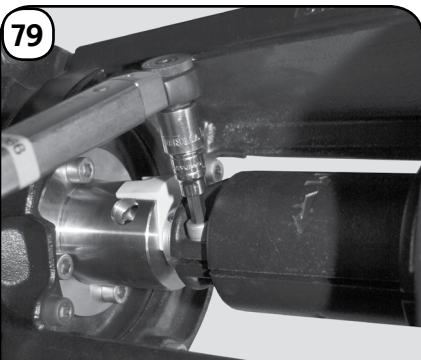

79 Torque the 8 mm hex socket coupling screws to 63 ft.-lbs./85 Nm. This step is the same for all pump types (in the photo a tandem seal version is shown).

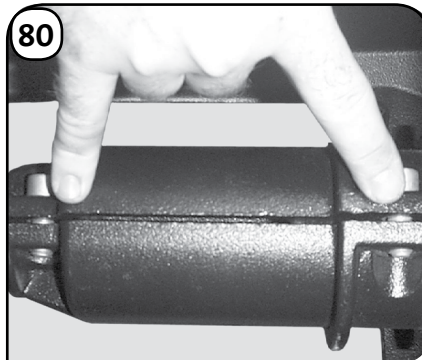

80 Make sure the gaps on both sides of the coupling are even. **Applies to all pump types.**

Standard, Cool Top® & Back-to-Back Seal Units

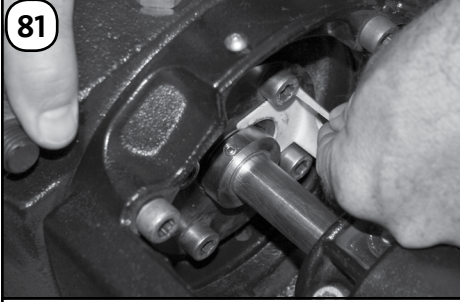

81

Remove the adjusting fork.

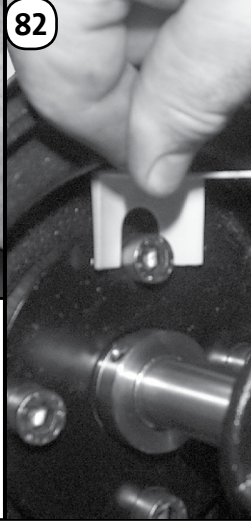

82

For storage, place the adjusting fork around one of the seal holder allen screws. Check rotation by turning the coupling by hand. If the shaft is tight or will not rotate, disassemble and begin the assembly procedure again.

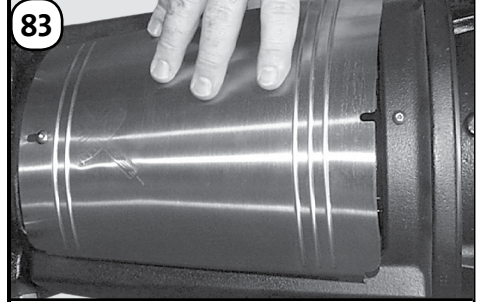

83

Fit Coupling Guard (Pos. 7) over screws (Pos. 7a). Torque to 6 ft.-lbs./8Nm.

Tandem Seal

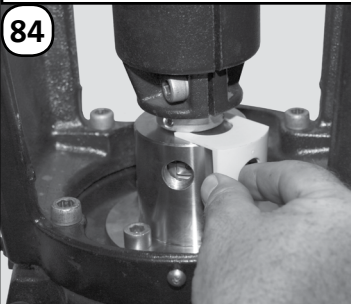

84

Remove the adjusting forks

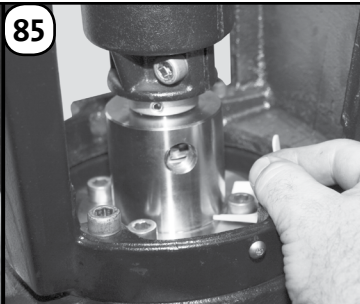

85

For storage, place the adjusting forks around two of the seal retaining screws. Check rotation by turning the coupling by hand. If the shaft is tight or will not rotate, disassemble and begin the assembly procedure again.

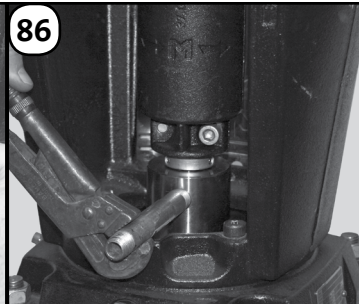

86

Install system piping to the tandem seal housing.



87

Fit the coupling guard and screws. Torque screws to 6 ft.-lbs./8Nm.

If the discharge adapter flange was removed, follow the steps in the gray boxed area on the next page.

If the Discharge Adaptor Flange and O-ring have been removed, replace following the next steps:



89
Apply Dow Corning 111 or Rocol to groove in Flange (Pos. 12a).

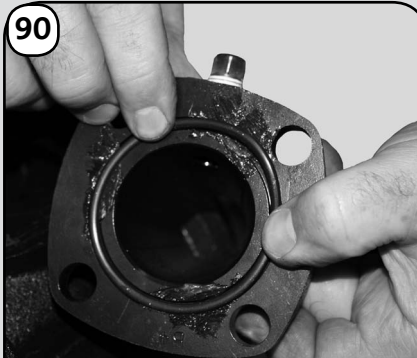

90
Place and seat O-ring (Pos. 39b).



91
Align flange position to locate 1/4" Pipe Plug (Pos. 23b). Diagonally torque Allen Screws (Pos. 35) to 15 ft.-lbs./20 Nm. Make sure flange is fully seated without any gaps.

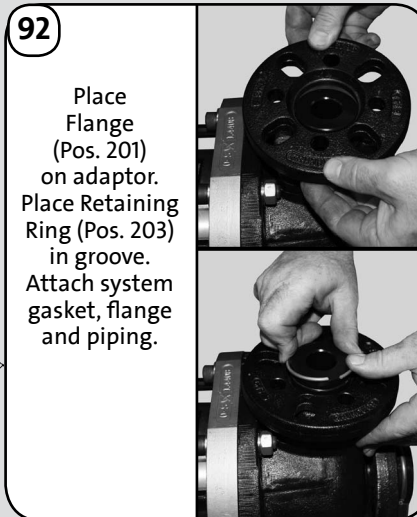

92
Place Flange (Pos. 201) on adaptor. Place Retaining Ring (Pos. 203) in groove. Attach system gasket, flange and piping.

———— THE PUMP IS ————
**NOW COMPLETELY
REASSEMBLED.**

Return the pump to the system and install it following the Installation and Operation instructions. If the unit was not removed from the system, open the isolation valves in the system piping to fully vent the pump. Confirm proper electrical connections before restoring power supply.

CR-H, CRN-H 32 Order of Stage Assembly

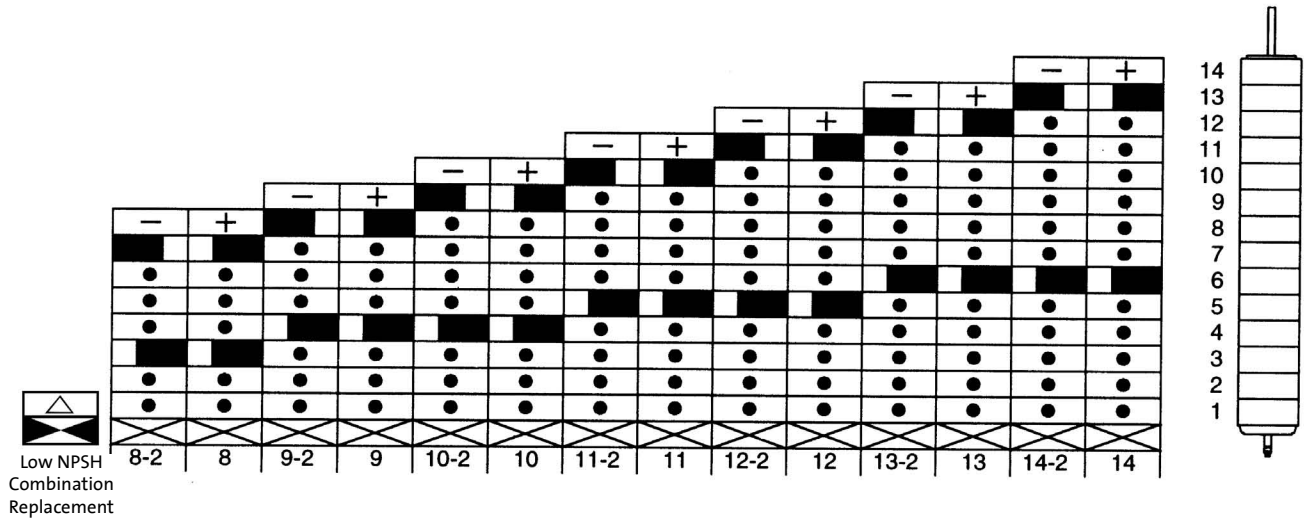
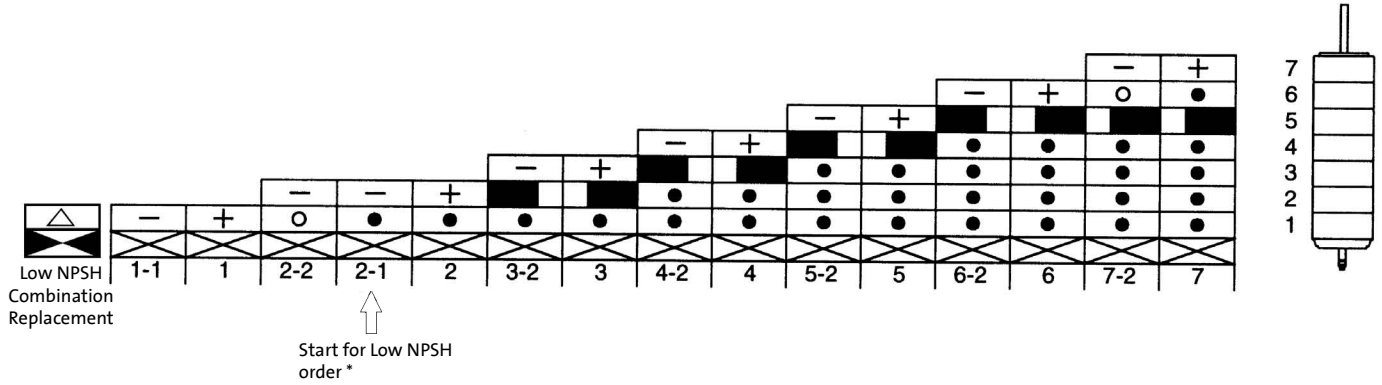

Legend

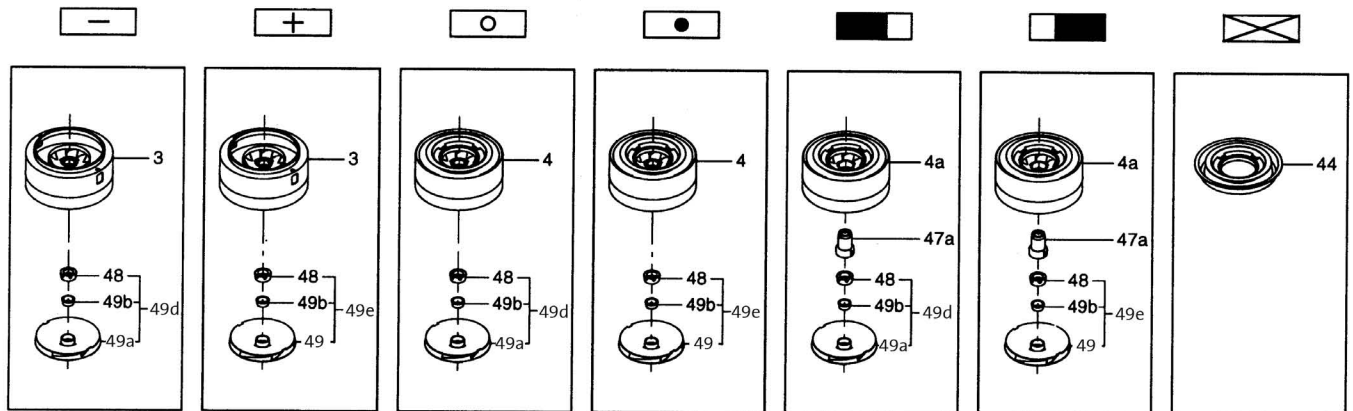

*Low NPSH units start with 2-1 and continue to the 14 stage.

NOTE: Refer to Parts List for ALL position descriptions.

For Low NPSH, replace the first 49e with 49i



For Low NPSH, replace 44 with 44a



CR-H, CRN-H 45

Order of Stage Assembly

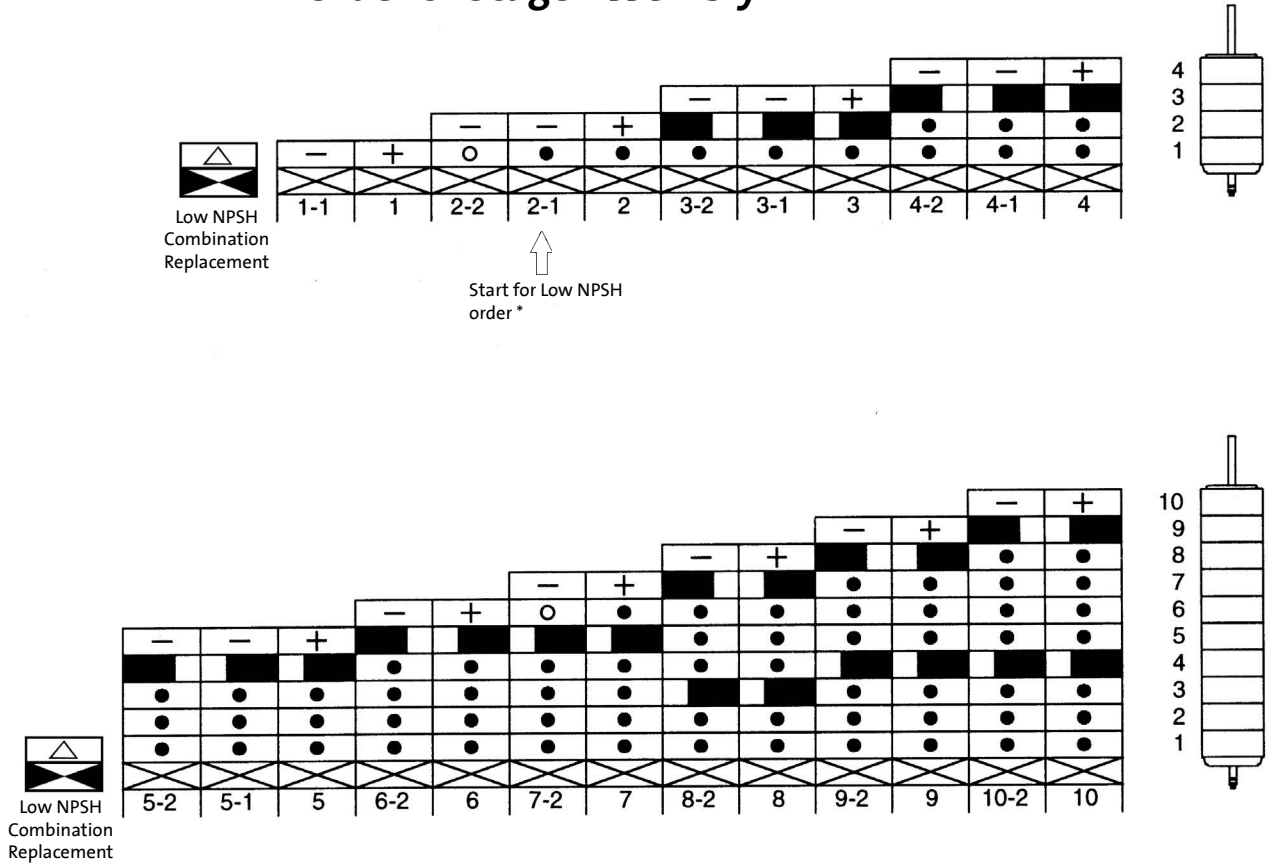

Legend

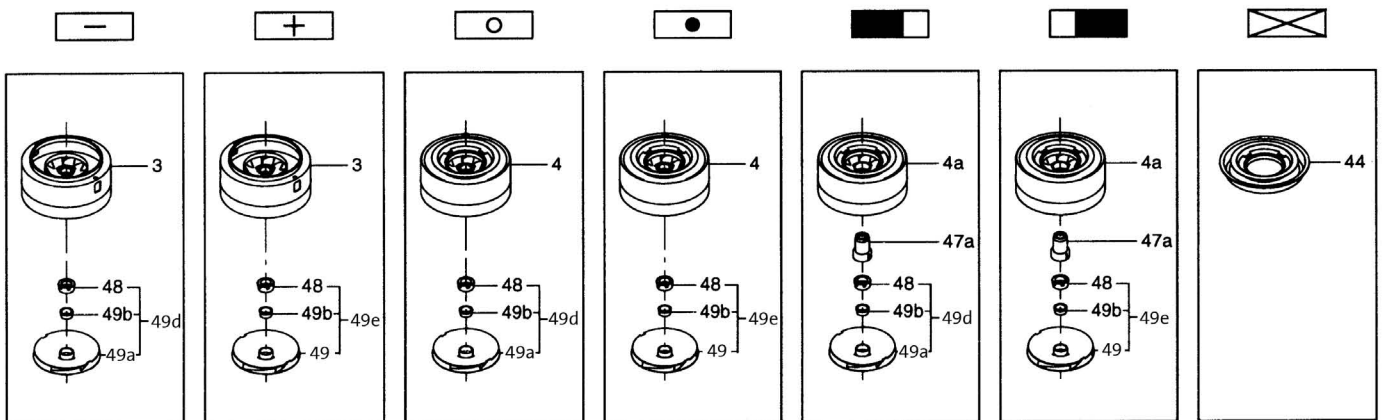

*Low NPSH units start with 2-1 and continue to the 10 stage.

NOTE: Refer to Parts List for ALL position descriptions.

For Low NPSH, replace the first 49e with 49i

For Low NPSH, replace 44 with 44a

CR-H, CRN-H 64

Order of Stage Assembly

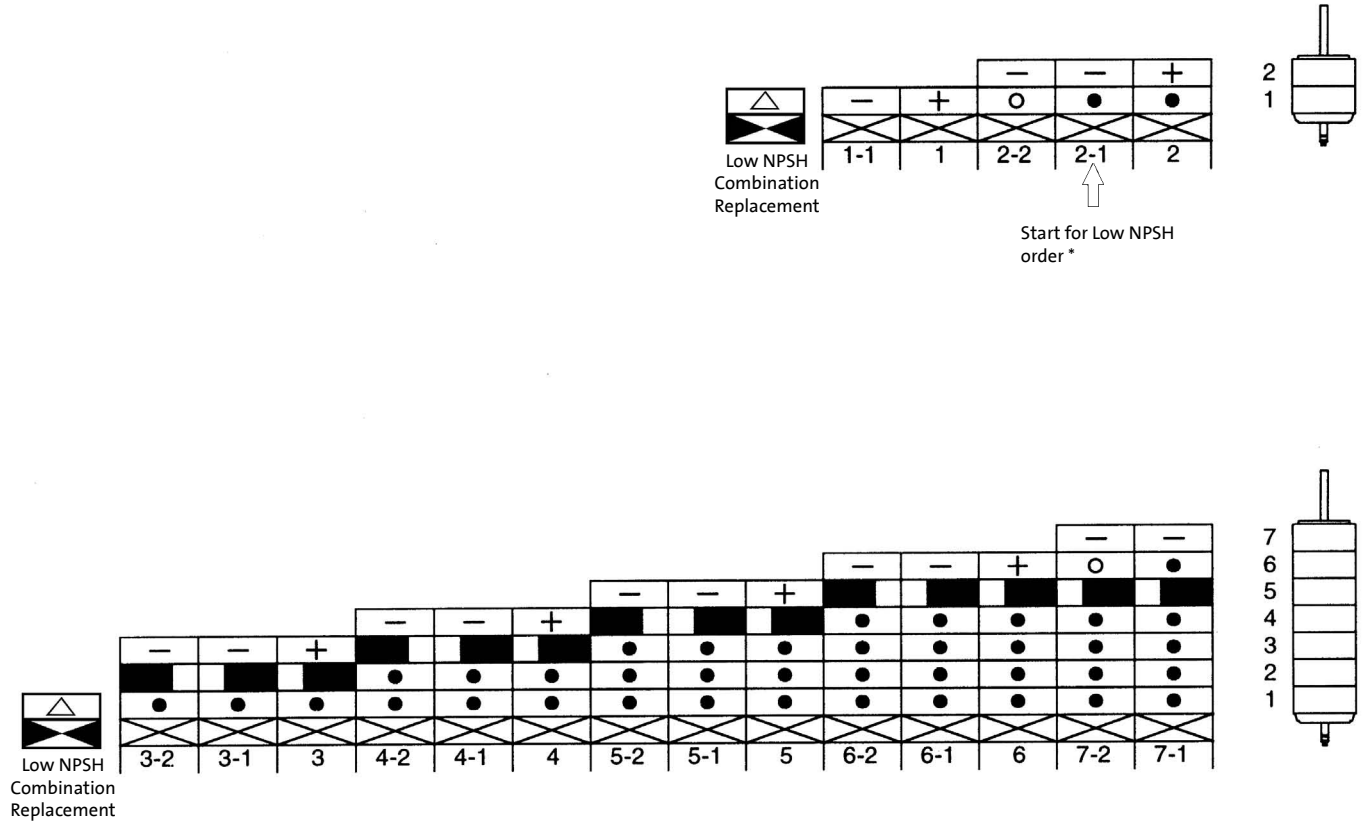

Legend

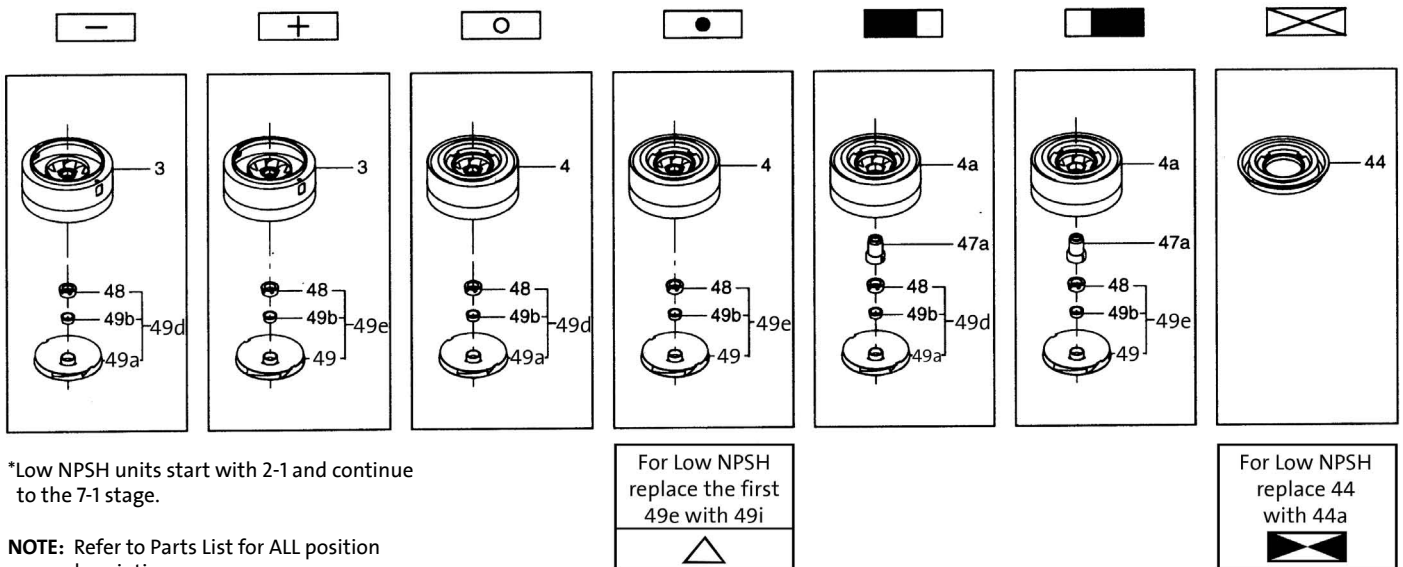

*Low NPSH units start with 2-1 and continue to the 7-1 stage.

NOTE: Refer to Parts List for ALL position descriptions.

CR-H, CRN-H 90

Order of Stage Assembly

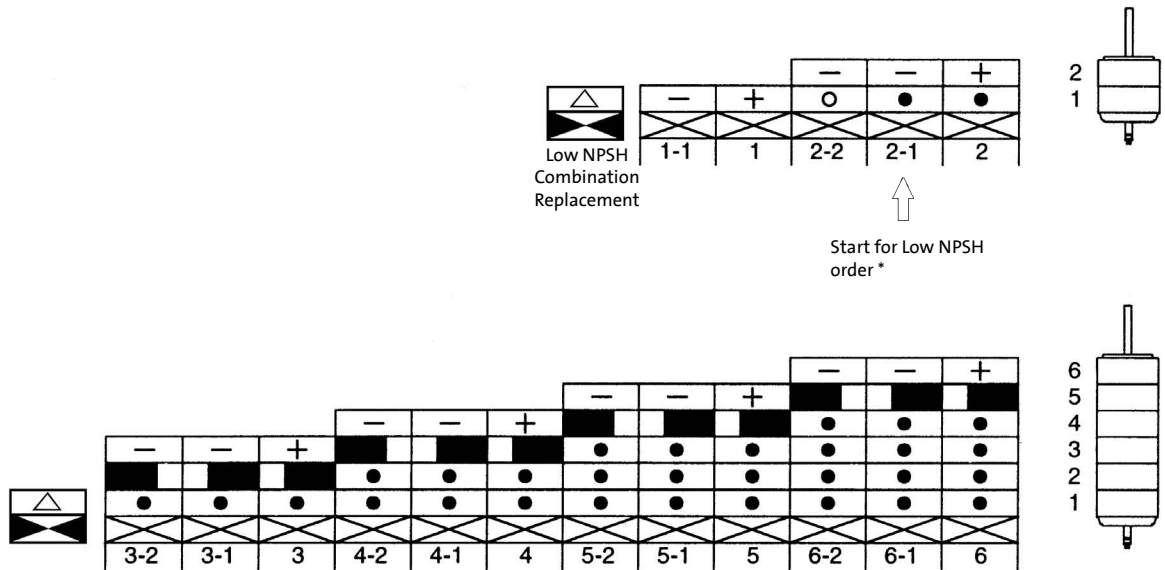

Legend

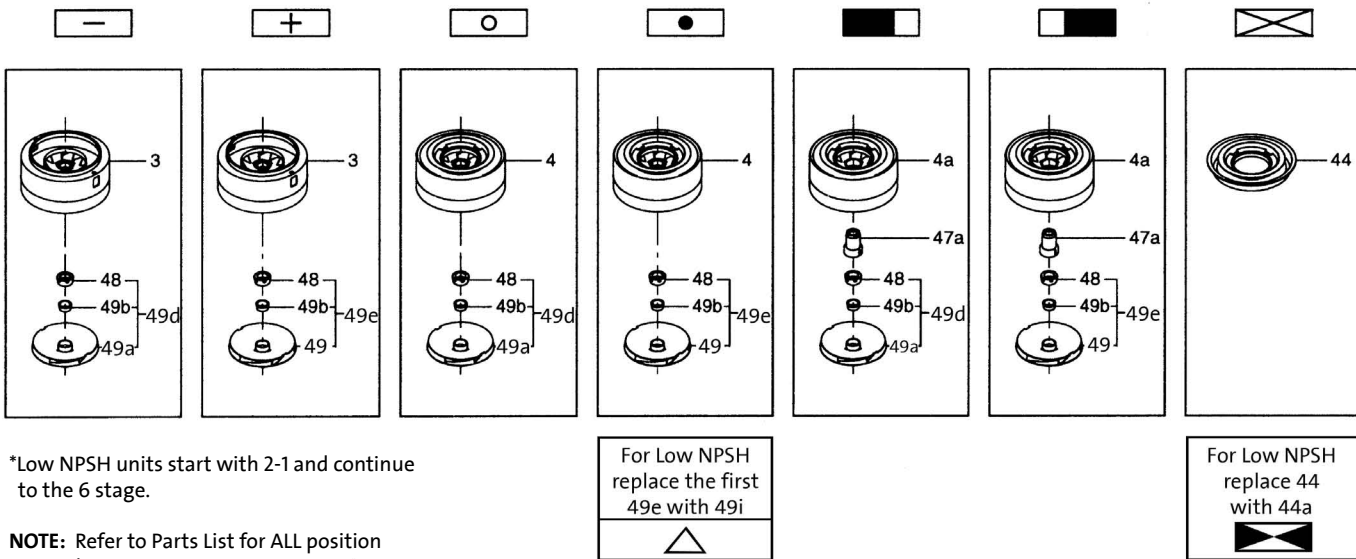

*Low NPSH units start with 2-1 and continue to the 6 stage.

NOTE: Refer to Parts List for ALL position descriptions.

For Low NPSH
replace the first
49e with 49i

For Low NPSH
replace 44
with 44a

L-SM-DR-101 0110

The name Grundfos, the Grundfos logo, and be think innovate are registered trademarks owned by Grundfos Holding A/S, Denmark. All rights reserved worldwide. © Copyright Grundfos Holding A/S

GRUNDFOS Pumps Corporation
17100 W. 118th Terrace
Olathe, Kansas 66062
Phone: 913.227.3400
Fax: 913.227.3500
www.grundfos.com

GRUNDFOS Canada, Inc.
2941 Brighton Road
Oakville, Ontario L6H 6C9 Canada
Phone: 905.829.9533
Fax: 905.829.9512

Bombas GRUNDFOS de Mexico S.A. de C.V.
Boulevard TLC No. 15
Parque Industrial Stiva Aeropuerto
Apodaca, N.L. Mexico 66600
Phone: 52.81.8144.4000
Fax: 52.81.8144.4010

