

DAVEY

DAVEY
DynaDrive™

Constant Pressure System

Installation and Operating Instructions

Models:	DD60-10(CE)	CE	DD60-10NPT	SGS C US
	DD90-11(CE)		DD90-11NPT	



ATTENTION: Please refer to www.bit.ly/dynadriv for any product information updates, or simply scan this QR code. These can also be found on the product nameplate.



**Please pass these instructions on to the operator of this equipment.
READ AND SAVE THESE INSTRUCTIONS.**

DAVEY DynaDrive™

Congratulations on your purchase of a high quality, Davey DynaDrive constant pressure system. All components have been designed and manufactured to give trouble free, reliable operation.

Contents

1. PRIOR TO USING THIS PRESSURE SYSTEM, YOU MUST ENSURE THAT	3
2. YOUR NEW SYSTEM.....	3
3. APPLICATIONS	4
3.1 Above ground water sources (flooded suction)	4
3.2 In-ground water sources (eg suction lift from in ground tank)	4
3.3 Spear point installations	4
3.4 Connecting mains scheme or town water supply to either suction, or discharge of pumps and pressure systems	4
3.5 Installs with a mains pressure hot water system	5
4. INSTALLATION	5
4.1 Choosing a site.....	5
4.2 Pipe connections	5
4.3 DynaDrive with air handling capacity	6
4.4 Power connection.....	6
4.5 The pressure tank	7
5. FEATURES	8
5.1 System features	8
5.2 DynaDrive display layout.....	8
5.3 VSD features	9
6. OPERATION	9
6.1 Start-up procedure	9
6.2 Manual override.....	11
6.3 Main menu display	13
6.4 Changing the set pressure	14
6.5 Extra draw-off capacity	16
6.6 Decommissioning the DynaDrive	16
7. ADVANCED SETTINGS.....	17
7.1 Changing cut-in pressure point	17
7.2 Changing the min frequency	18
7.3 Using a switch to override DynaDrive operation	20
7.4 Daisy-chain multiple DynaDrive systems	23
8. TECHNICAL SPECIFICATIONS	25
8.1 Operating limits	25
8.2 Hydraulic performance	25
8.3 Dimensions.....	26
8.4 Electrical data.....	26
8.5 Materials of construction	26
10. MAINTENANCE	27
10.1 Periodic pressure tank checks	27
11. TROUBLESHOOTING	28
12. SPARE PARTS.....	28
13. DAVEY WARRANTY	31
13.1 Warranty inside the USA	31
13.2 Warranty inside the USA	32



CAUTION: This pump has been evaluated for use with water only. Do not insert any object in the opening. Before using this pump, the pump must be well installed. Children should be supervised that they do not play with the pump. NPT model variants acceptable for indoor use only, do not used outdoor. For use with maximum 80°C (176°F) water.



WARNING: Risk of electric shock. This pump is supplied with a grounding conductor and grounding-type attachment plug. To reduce the risk of electric shock, be certain that it is connected only to a properly grounded, grounding-type receptacle. Non-submersible pump. This pump has not been investigated for use in swimming pool or marine areas. To reduce risk of electric shock, pull plug before servicing or cleaning this pump. Do not operate this pump with wet hands.



ATTENTION: The DynaDrive system and associated pipework operate under pressure. Under no circumstances should the DynaDrive system, or associated pipework be disassembled unless the internal pressure of the system has been relieved. Failure to observe this warning will expose persons to the possibility of personal injury and may also result in damage to the pump, pipework or other property.

This appliance is not intended for use by persons (including children) with reduced physical, sensory or mental capabilities, or lack of experience and knowledge, unless they have been given supervision or instruction concerning use of the appliance by a person responsible for their safety. Children should be supervised to ensure that they do not play with the appliance. This appliance can be used by children from aged 8 years and above and persons with reduced physical sensory, mental capabilities, or lack of experience and knowledge if they have been given supervision, or instruction concerning use of the appliance in a safe way and understand the hazards involved. Maximum pressure limited to 64m (210 feet) total head.



IMPORTANT: If the supply cord is damaged, it must be replaced by the manufacturer, its service agent, or similarly qualified persons in order to avoid a hazard. Pump is to be supplied through a residual current device (RCD) having a rated residual operating current not exceeding 30mA. Cleaning and user maintenance shall not be made by children without supervision. Children shall not play with the appliance.

Prior to installation remove the inlet and outlet pipe transport plugs & associated seals from the suction and/or discharge ports.

1. PRIOR TO USING THIS PRESSURE SYSTEM, YOU MUST ENSURE THAT

- The pump is installed in a safe and dry environment
- The pump enclosure has adequate drainage in the event of leakage
- Any transport plugs are removed
- The pipework is correctly sealed and supported
- The pump is primed correctly
- The power supply is correctly connected
- All steps have been taken for safe operation

Appropriate details for all these items are contained in the following Installation and Operating Instructions. Read these in their entirety before switching on this pump. If you are uncertain as to any of these Installation and Operating Instructions, please contact your Davey dealer, or the appropriate Davey office as listed on the back of this document.

2. YOUR NEW SYSTEM

1. Suction inlet
2. Pump body
3. Pump priming plug
4. Discharge/delivery outlet
5. DynaDrive control module
6. Motor
7. Pressure tank
(optional extra for CE model variants)

DD60-10, DD90-11

Figure 2.1

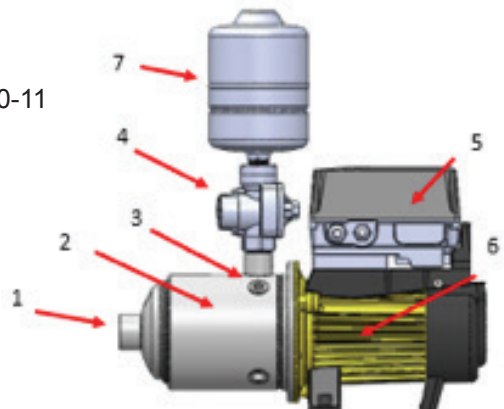

3. APPLICATIONS

3.1 Above ground water sources (flooded suction)

Installations with flooded suction require a gate valve so water supply can be turned off for pump removal and servicing, see figure 3.1. There is no need to install a one-way check valve in the suction pipeline as there is a one-way check valve installed in the tee piece immediately on top of the DynaDrive pump discharge.

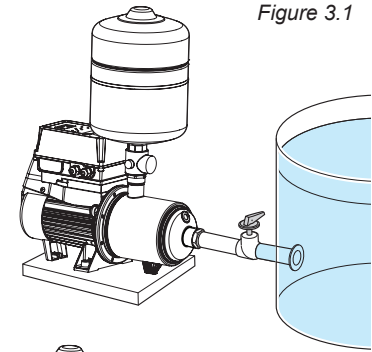

Figure 3.1

3.2 In-ground water sources (eg suction lift from in ground tank)

Whenever the installation position of the pump is higher than the lowest water level, a foot valve should be fitted to the end of the suction pipe, see figure 3.2. Ensure that the foot valve is at least ½ metre (1½ feet) below minimum water level to avoid a vortex of air being drawn into pipe.

In suction lift installations that have an unreliable foot-valve it may be preferable to remove the check valve in the DynaDrive discharge tee piece. Doing so will allow the DynaDrive pressure transducer to “recognise” a loss of water from a suction line, while the DynaDrive is in standby. Applications of this nature, with long &/or wide suction lines consist of a considerable volume of water, ie > 100 litres (26 US gallons) in the suction pipe. Temperature variations of the water may create fluctuations in the pressure of the water, falsely triggering the DynaDrive to start/stop. In such as case, it is worth considering upsizing the pressure tank to help absorb these pressure fluctuations. If concerned, please consult your Davey representative.

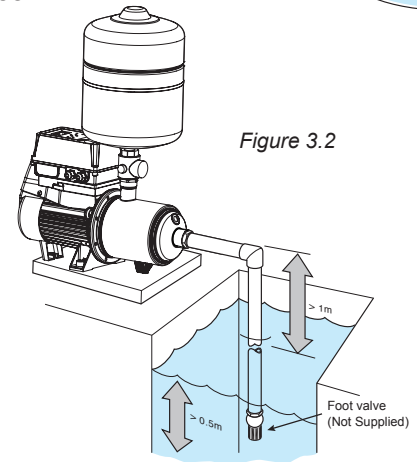

Figure 3.2

3.3 Spear point installations

When a pump is installed on a spear, or well point, a check valve fitted immediately on top of the spear point itself, see figure 3.3. Do not install the check valve at the pump, or at the top of the well. Do not run the pump without water in it.

In suction lift installations that have an unreliable foot-valve it may be preferable to remove the check valve in the DynaDrive discharge tee piece. Doing so will allow the DynaDrive pressure transducer to “recognise” a loss of water from a suction line, while the DynaDrive is in standby. Applications of this nature, with long &/or wide suction lines consist of a considerable volume of water, ie > 100 litres (26 US gallons) in the suction pipe. Temperature variations of the water may create fluctuations in the pressure of the water, falsely triggering the DynaDrive to start/stop. In such as case, it is worth considering upsizing the pressure tank to help absorb these pressure fluctuations. If concerned, please consult your Davey representative.

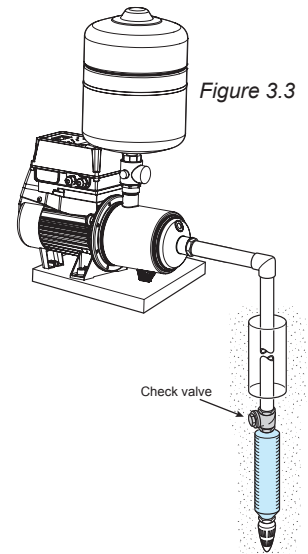

Figure 3.3

3.4 Connecting mains scheme or town water supply to either suction, or discharge of pumps and pressure systems

Most Water Supply Authorities have strict regulations regarding direct connection of pumps to mains water supplies. In most cases an isolating tank is required between mains supply and pump, see figure 3.4. Davey also recommend this method. Directly applied mains pressure can exceed pump operating pressure and damage pump. Davey Water Products Pty Ltd cannot accept responsibility for loss, or damage resulting from incorrect, or unauthorized installations.

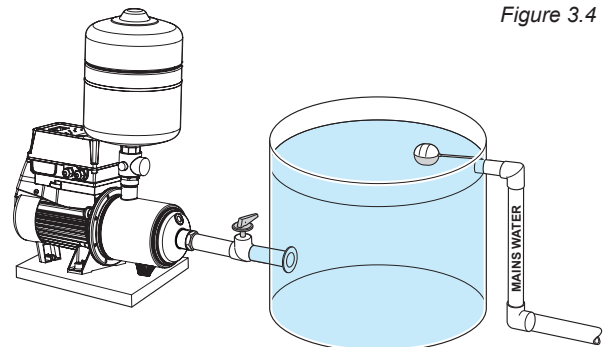

Figure 3.4

3.5 Installs with a mains pressure hot water system



ATTENTION: Always ensure hot water systems are installed in compliance with manufacturers recommendations and in accordance with all local regulations.

To protect your system from damage caused by back pressure from hot water systems, see figure 3.5. You should always have installed on the hot water inlet an approved non-return valve.

Davey Water Products Pty Ltd cannot accept responsibility for loss or damage resulting from incorrect, or unauthorised installations.

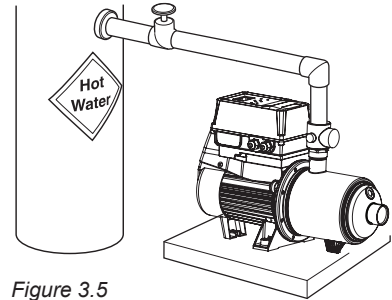

Figure 3.5

4. INSTALLATION

4.1 Choosing a site

Choose a clean and dry site with a firm base as close to the water source as possible with correct power supply. Make sure your pump is always connected to an adequate, reliable source of clean water. To protect your pump from the weather, make sure the pump house is both waterproof, frost free and has adequate ventilation. The pump should be mounted on a firm base allowing for drainage, to avoid damage to flooring etc., that over time may occur from leaking pipe joints or pump seals. Do not mount the pump vertically. Never place flammable materials on, or near your pump.

The pressure that DynaDrive comes pre-set to is as follows:

- * DD60-10(CE) 400kPa (58psi);
- * DD90-11(CE) 400kPa (58psi);
- * DD60-10NPT 414kPa (60psi); or
- * DD90-11NPT 414kPa (60psi).

However, it is possible to adjust the pressure set point. Some plumbing authorities impose a pressure limitation on the pressure of water into a dwelling. Consideration of operating pressures should also be given to appliances within the dwelling. If unsure, check with local authorities, or a licenced contractor.

4.2 Pipe connections



IMPORTANT: Suction leaks are the largest cause of poor pump performance and are difficult to detect. Ensure all connections are completely sealed using thread tape only. **DO NOT USE SEALING COMPOUNDS, HEMP, OR PIPE DOPE.**

For best performance use P.V.C, or polythene pipe with a diameter at least the same as the pump's inlet. Larger diameter pipe may be used to minimise resistance to flow when pumping for distances longer than 5m (16'). Use unions at pipe connections to enable easy removal and servicing.

Use enough "plumbers' tape" to ensure airtight seal and hand tighten only, do not screw connections all the way into suction port, see figure 4.1. To prevent

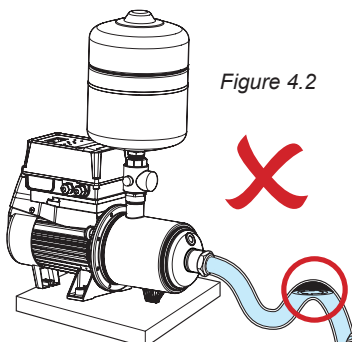

Figure 4.2

strain on pump thread always support heavy inlet and outlet pipes.

Lay suction pipe at a constant gradient to avoid air pockets which may reduce pump efficiency, see figure 4.2.

Avoid installing 90° elbows before the suction inlet of the pump, within a distance equivalent to 5 x pipe diameter. For example: using 40mm (1½") suction pipe, avoid installing a 90° elbow within 200mm (7¾") of the pump inlet. This will assist laminar flow.

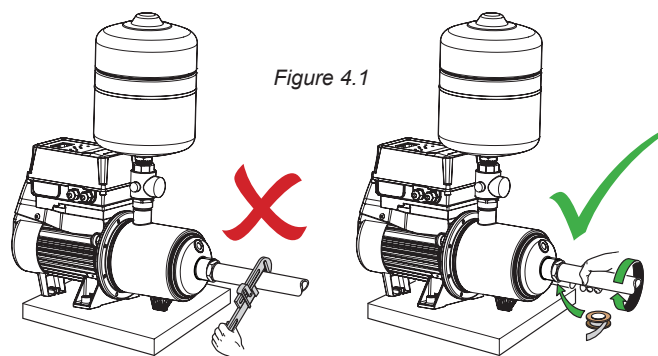

Figure 4.1

4.3 DynaDrive with air handling capacity

Your DynaDrive has the benefit of a new upgraded self-priming and air handling capability. While Davey must stress the overall requirement for all suction lines to be airtight, we also are aware that sometimes removing air from suction lines or stopping minor leaks can be difficult. For this reason, Davey have incorporated special features into your new pump or pressure system to make operation easier and more dependable.

To help you get the most from this new capability please read this addendum in conjunction with the full Installation and Operating Manual included with your pump.

Plumbing: Pay special attention to ensuring the suction pipe and associated fittings are airtight. The absence of a water leak on the suction line may not confirm that the pipe or fittings are airtight.

Should the suction line contain air pockets it can aid the priming process greatly if you can temporarily isolate the discharge line from the pump and instead use an adjacent tap to allow the pump to discharge water until full prime is established. Such a facility is also useful for future servicing and troubleshooting should it be required.

Priming: Filling the pump and suction line with water is made much easier by filling from the outlet side and allowing any trapped air in the pump to evacuate via one of the plugged holes on the pump casing.

- Remove the tee piece on the top of the pump when trying to fill as this contains a check (one-way) valve, that won't otherwise allow water to enter the pump casing;
- Remove priming plug and fill casing and suction line (on flooded suction, simply open gate valve to pump). When full, replace priming plug;
- Ensure outlet nearest to pump is open;
- Ensure all valves in suction line are open;
- Switch on power. All LEDs on the display will flash;
- Refer section "6.1 Start Up Procedure". A full flow of water should be discharged from the open tap.

4.4 Power connection



IMPORTANT: Long extension leads should be avoided as they often have insufficient current carrying capacity to run electric motors, hence they can cause substantial voltage drop and operating problems.

If the electrical fittings in your country make it necessary to remove the plug from the lead fixed to the motor care should be taken to ensure that the earth conductor green/yellow in the lead is properly connected to a good earth. CAUTION: For models DD60-10NPT and DD90-11NPT, compliance dictates removal of the power cord and plug is not allowable.



ATTENTION: Ensure that any and all electrical work is only undertaken by an authorized electrician. Before obtaining access to terminals, all supply circuits must be disconnected.

The electrical connections and checks must be made by a qualified electrician and comply with applicable local standards. Poor installation, or poor power supply may even result in electrical fires!



ATTENTION: Automatic reset thermal overloads will allow the pump to restart without warning. ALWAYS disconnect the pump motor from the electrical supply before maintenance or repairs.

NOTE:

- Ensure motor is connected to power supply specified on nameplate;
- Although the Davey electric motor is specifically engineered to perform on a range of power supply voltages, malfunctions or failure caused by adverse voltage supply conditions are not covered under guarantee.



ATTENTION: We are obliged to inform you that this pump is not to be used by children, or infirm persons and must not be used as a toy by children. Some insects such as small ants, find electrical devices attractive for various reasons. If your pump enclosure is susceptible to insect infestation you should implement a suitable pest control plan.

4.5 The pressure tank



IMPORTANT: Air pressure in pressure tank should be set to 70% of the DynaDrive set pressure. For example, the pressure that DynaDrive comes pre-set to is as follows:

DD60-10(CE) 400kPa (58psi);
DD90-11(CE) 400kPa (58psi);
DD60-10NPT 414kPa (60psi); or
DD90-11NPT 414kPa (60psi).

The default air pressure of the pressure tank used with DynaDrive should be set to:

DD60-10 280kPa (41psi);
DD90-11 280kPa (41psi);
DD60-10CE 280kPa (41psi) tank purchased separately;
DD90-11CE 280kPa (41psi) tank purchased separately;
DD60-10NPT 290kPa (42psi); or
DD90-11NPT 290kPa (42psi)

Never over-charge the tank. Always use air at ambient temperature. Do not overtighten. During air replenishment the tank should be externally inspected. Any signs of leakage from the tank may indicate a need for immediate replacement.

If air charge adjustment is required, then follow these procedures:

- Remove the pressure tank completely from pump installation, ensuring to isolate the pressure tank and release the water pressure from the tank beforehand; or
- Release all water pressure from the pressure tank by switching off the pump at the power point and opening the closet tap. For above ground supply tanks, it is necessary to close the gate valve between the supply tank and the pump;



ATTENTION: To prevent personal injury, ensure all water pressure is released from the pressure system prior to work being performed.

- Leave tap open during air replenishment;
- When all water pressure has been released from the system, check air pressure at air valve on top of pressure tank. The pre-charge pressure reading should be 70% of set point pressure;
- If necessary, replenish air charge to the correct pressure indicated. Ensure that a tap in outlet piping of pump is open during replenishment of air pre-charge.

5. FEATURES

5.1 System features

- Provides warning indications for system faults;
- Has adjustable pressure setting to allow for various operating conditions;
- Provides automatic “cut-out” protection should the pump run out of water, should the pump fail to start due to low voltage or a blockage in the pump;
- Enables the pump to deliver a constant pressure of water particularly across a wide range of flow rates – reducing the inconvenience of pressure variation in showers etc.
- * Allows for independent switch to override DynaDrive operation. This could be particularly handy if using a float switch in a source tank;
- * Allows for remote alarm monitoring;
- * Allows for daisy-chain multiple DynaDrive systems; and
- * Allows for adjustment of cut-in pressure. This could be particularly handy in applications with slow leaks.

5.2 DynaDrive display layout

Figure 5.1

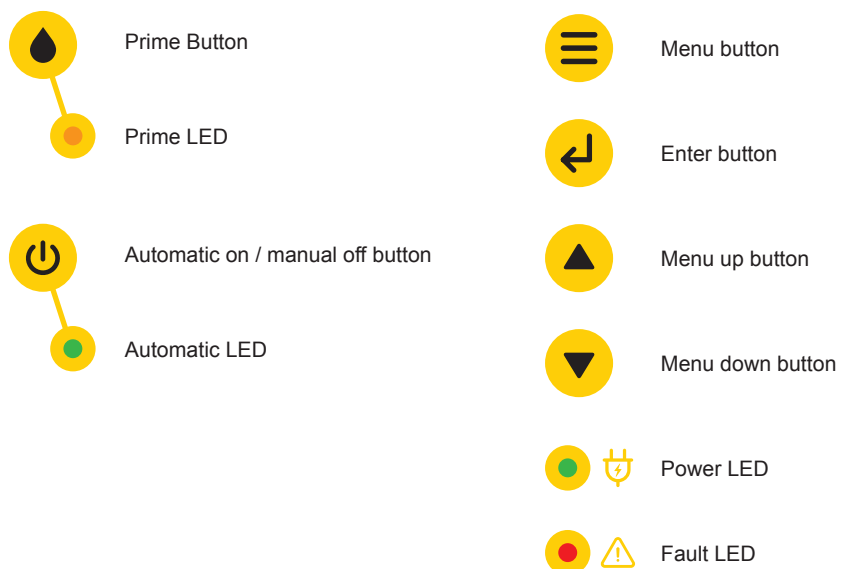
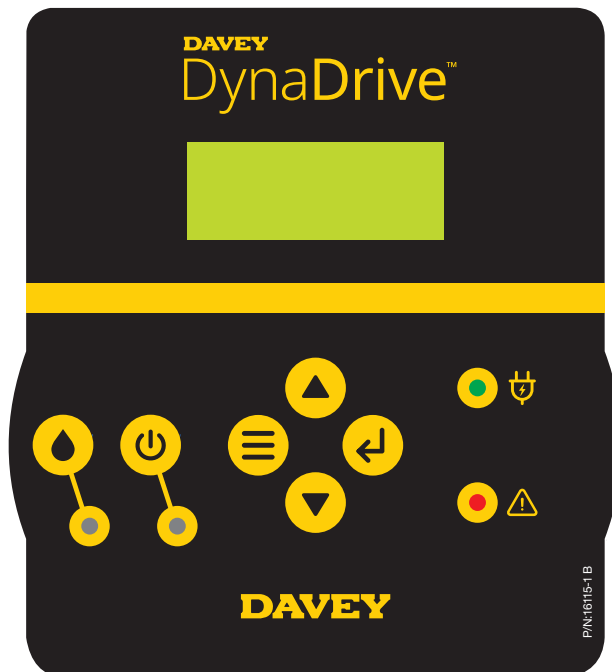

5.3 VSD features

- Auto reset after dry run detected;
- Auto reset after loss of power;
- Option for adapting (volt-free) tank level sensor into programming;
- Control and information panel with LCD screen;
- Includes pressure transducer;
- Under current visual alarm;
- Over current protection by way of shut down and visual alarm;
- Data logging of operation controls and alarms including run duration;
- Aluminum heat exchanger;
- VSD cooling by pump's fan, lowering cooling costs by way of additional fans;
- Motor and VSD protection from onsite "brown-outs" by way of shut down, visual alarm & auto re-try after correct voltage regained;
- Protection from motor locked rotor by way of auto shut down;
- Adaptable for daisy-chain multiple pumps in parallel, up to 2 pumps;
- Fault diagnosing software for user troubleshooting;
- Adjustable pressure set points via easy to use touchpad in 10kPa (1½psi) increments;; and
- 3-minute manual override for priming.

6. OPERATION

6.1 Start-up procedure

After power is initially turned on to the DynaDrive, the display shows the software version and the name Davey, see figure 6.1. All LEDs flash for the initial ~ 5 seconds. The  **Power LED** will remain lit green, showing the DynaDrive has power.

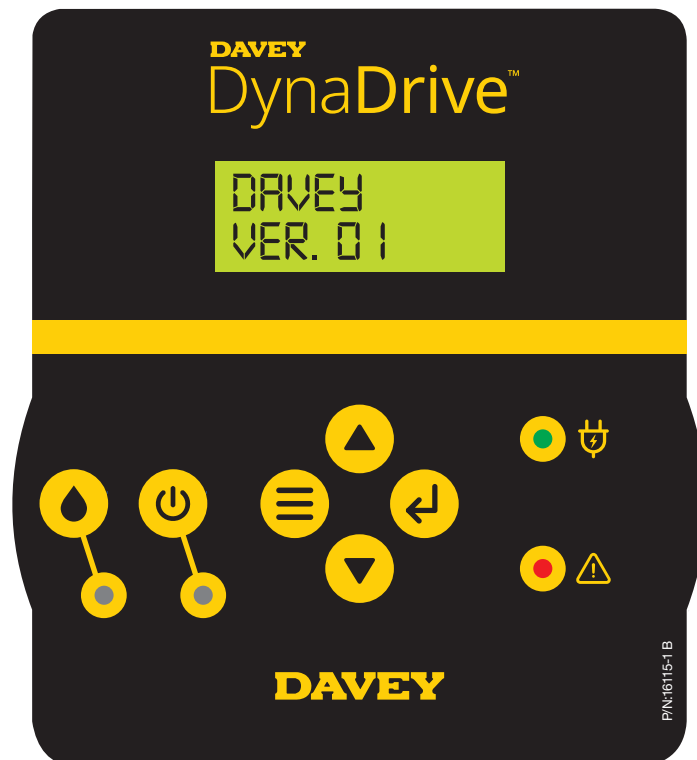



Figure 6.1

The display then reverts to the **HOME SCREEN**, see figure 6.2. The  **Power LED** will show bright green. The display shows the pre-set pressure on the top line, shown in Figure 6.2, and pressure being measured by the DynaDrive pressure transducer on the bottom line, shown in Figure 6.2.

The default unit of measurement is as follows:

- * DD60-10(CE): kPa;
- * DD90-11(CE): kPa;
- * DD60-10NPT: psi; or
- * DD90-11NPT: psi.

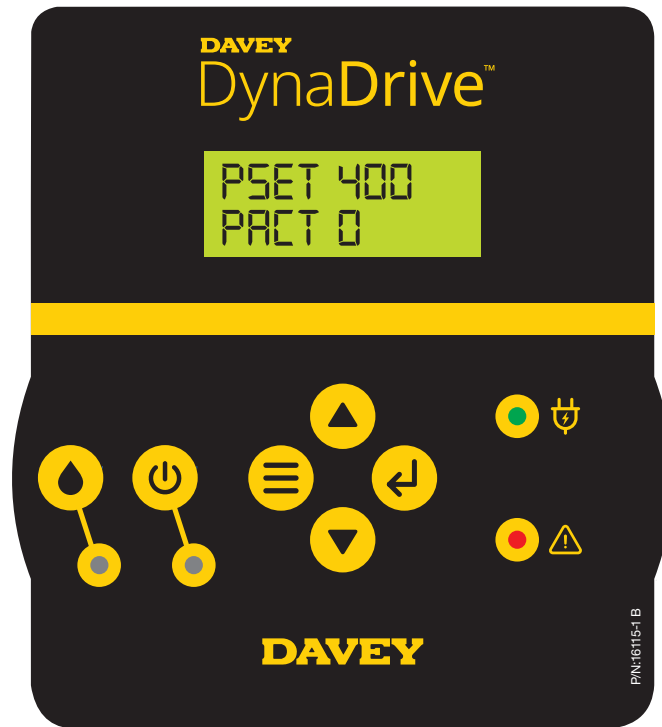



Figure 6.2

To start the DynaDrive:

- Pushing the  **Automatic on / manual off button** toggles between **automated control** and **manual off**;
- Pushing the  **Automatic on / manual off button** will turn on the pump and it will continue to pump water until set pressure is achieved, see figure 6.3;

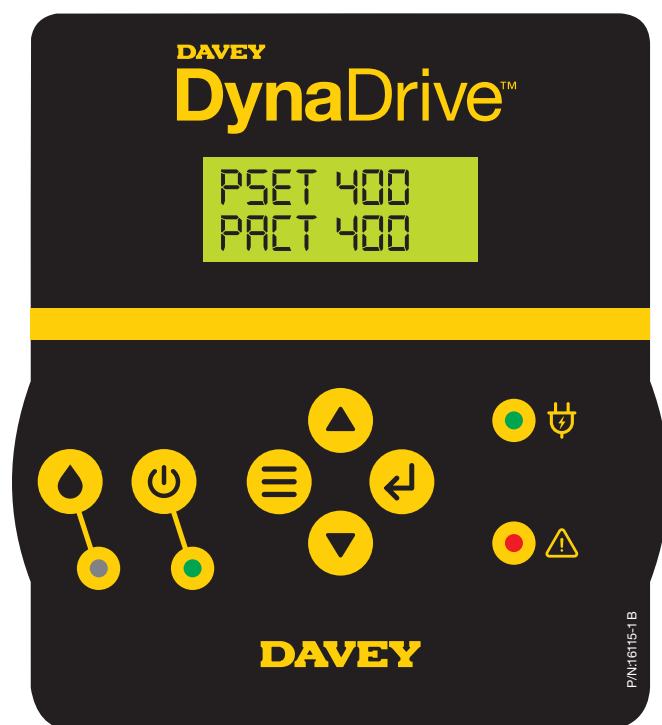



Figure 6.3

- The  **Automatic LED** will illuminate bright green indicating that the pump is running

Once the set pressure has been achieved, the DynaDrive will slow the motor speed. If the pressure drops below set pressure, the motor speed will increase again to maintain pressure. However, if the pressure does not drop below set pressure, the motor speed will continue to decrease, until it's off.

- The  **Automatic LED** will flash green to indicate the pump is in standby maintaining pressure, see figure 6.4.

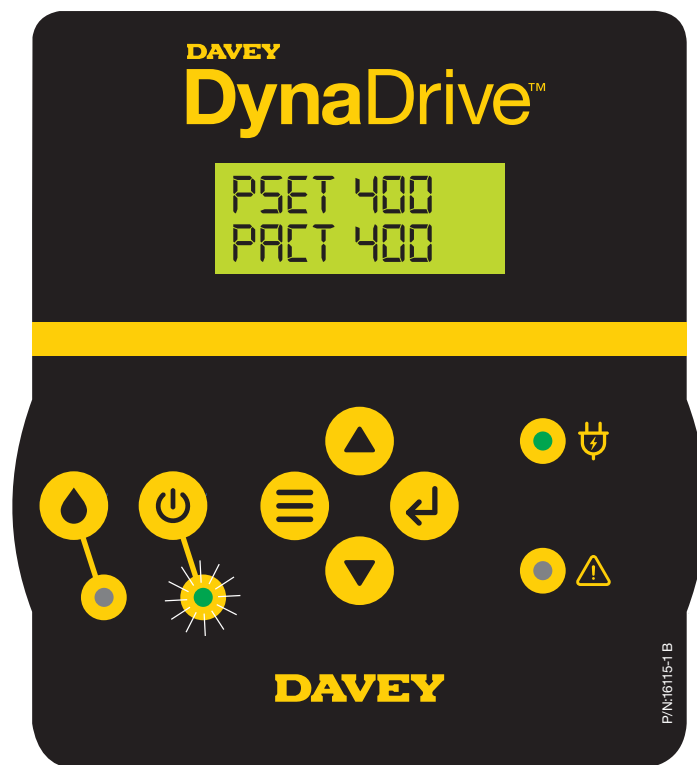

Figure 6.4

6.2 Manual override

In addition to automated control, DynaDrive can also be run in manual override on, should the need arise.



IMPORTANT: It should be noted that when the pump is manually turned on, the automated protection built into DynaDrive is overridden. Davey recommends use of the manual override only when absolutely necessary and only for a short time period.

To switch to manual override on:

- Ensure **automated control** is turned off. To turn the automated control off, push the  **Automatic on / manual off button**.

- The green  **Automatic LED** will turn off, see figure 6.5;

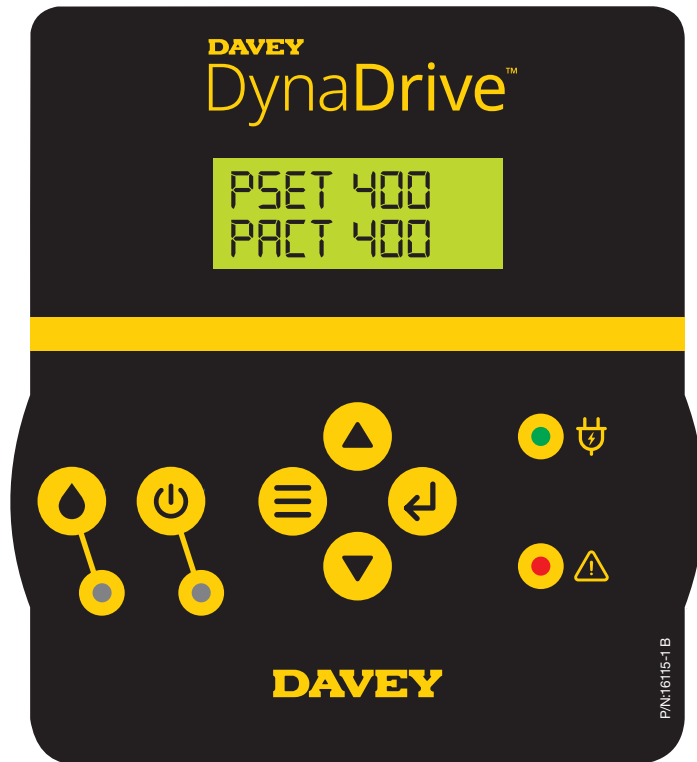



Figure 6.5

- Press and hold the  **Prime button**. The pump will turn on and continue to run until the  **Prime button** is released, see figure 6.6;

While the pump is in manual override the  **Prime LED** will illuminate orange, see figure 6.6.

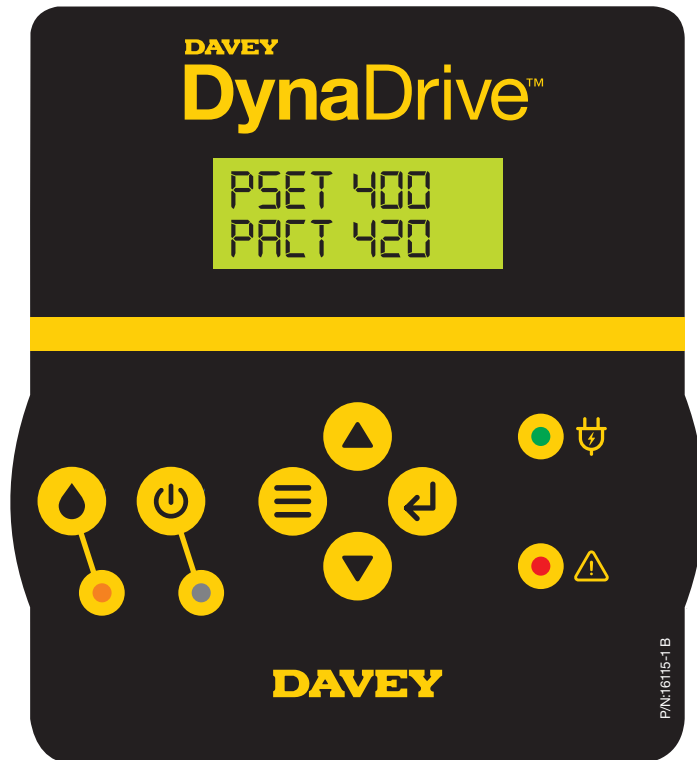

Figure 6.6

6.3 Main menu display

After initial startup, pressing the **▲ Menu up button** will allow display to scroll through the following:

- Frequency (Hz);
- Outgoing current per phase from the DynaDrive to the pump's motor (Amps);
- Temperature of the DynaDrive ($^{\circ}\text{C}$).

To change the display:

- Press the **▲ Menu up button**;
- The display will continue to show the pressure set, but changes from showing actual pressure, to the frequency of power supplying the motor, see figure 6.7. This dictates the speed that the motor runs;

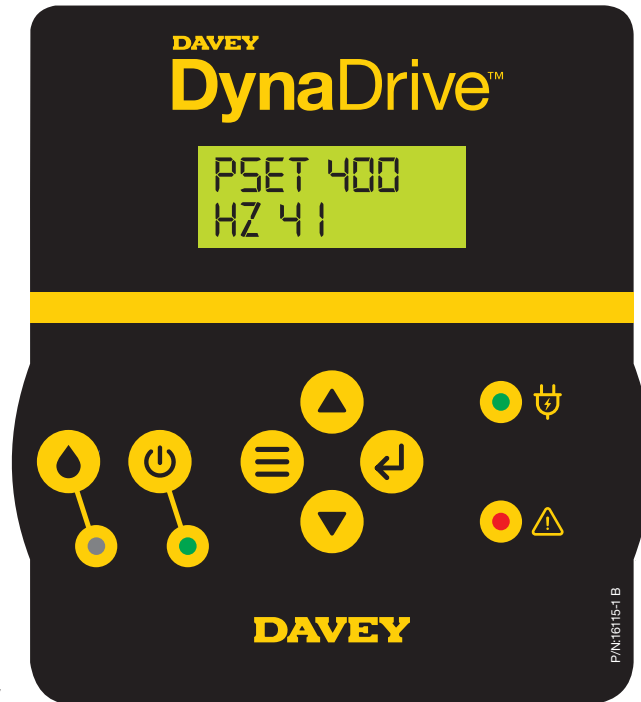

Figure 6.7

- Pressing the **▲ Menu up button** again will display the motor current draw per phase, and the temperature of the DynaDrive controller, see figure 6.8;

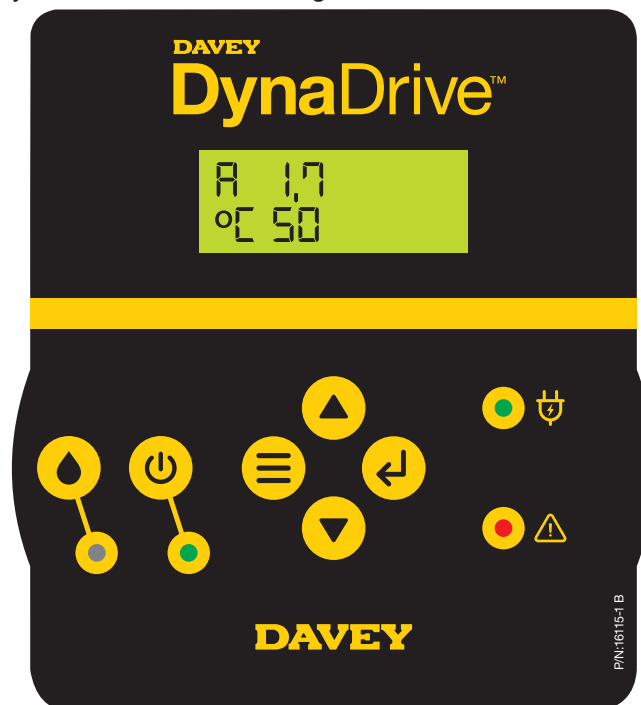

Figure 6.8

- To change the display back to normal, scroll back through the menu by pressing the **▼ Menu down button** twice.

6.4 Changing the set pressure



IMPORTANT: WHEN ADJUSTING SET PRESSURE, DO NOT EXCEED THE PRESSURE CAPABLE OF THE DYNADRIVE IN THE GIVEN INSTALLATION. REFERENCE TO AS/NZS 3500/2003 (OR LOCAL EQUIVALENT) SHOULD ALSO BE CONSIDERED. When changing the set pressure of DynaDrive, the pressure of the pressure tank must also be adjusted. Refer to section 4.5 pressure tank, of the installation chapter.

The set pressure cannot be changed while the pump is running, or in automatic mode. To change the set pressure:

- Ensure **automated control** is turned off. To turn the automated control off, push the  **Automatic on / manual off button**.

- The green  **Automatic LED** will turn off, see figure 6.5;

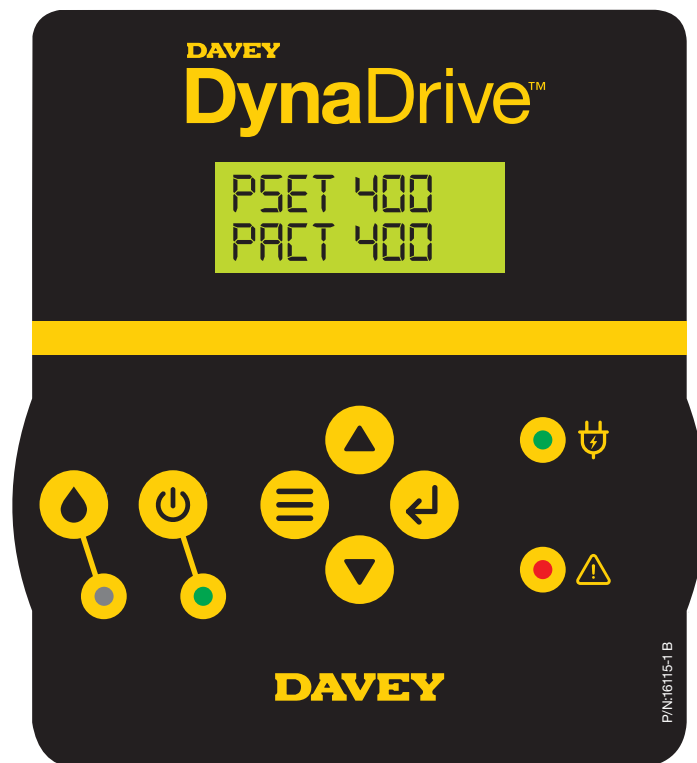



Figure 6.9

- Once the motor has slowed to a stop, press and hold the  **Menu button** for ~ 5 seconds. The display will change to show your current set pressure, see figure 6.10;

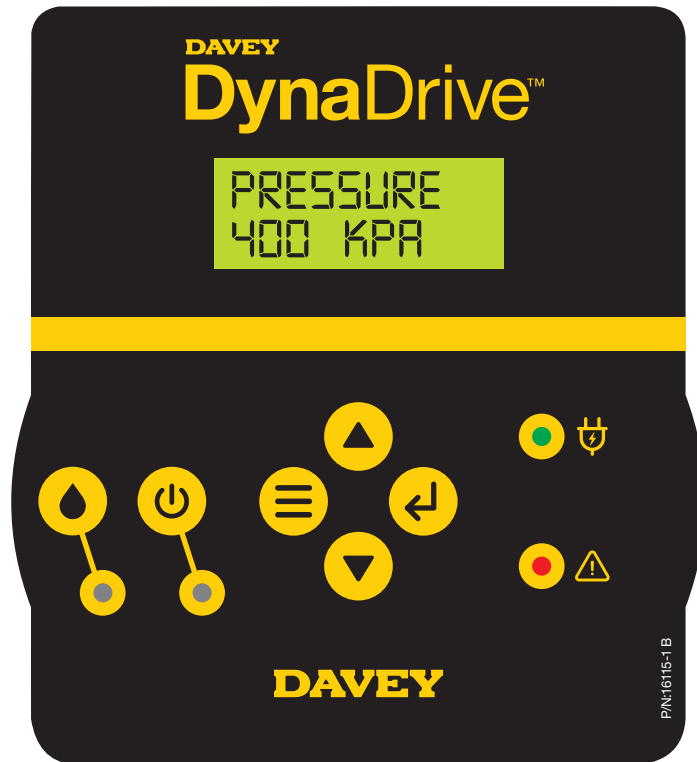

Figure 6.10

- If the controls are untouched for ~ 30 seconds, the menu will revert back to normal display;
- To change the set pressure, use the ▲ **Menu up button** or ▼ **Menu down button**. Pressure changes are in multiples of 10kPa for DD60-10(CE) and DD90-11(CE) models, and 5psi for NPT model variants.
- Once you've reached your new set point, see figure 6.11;

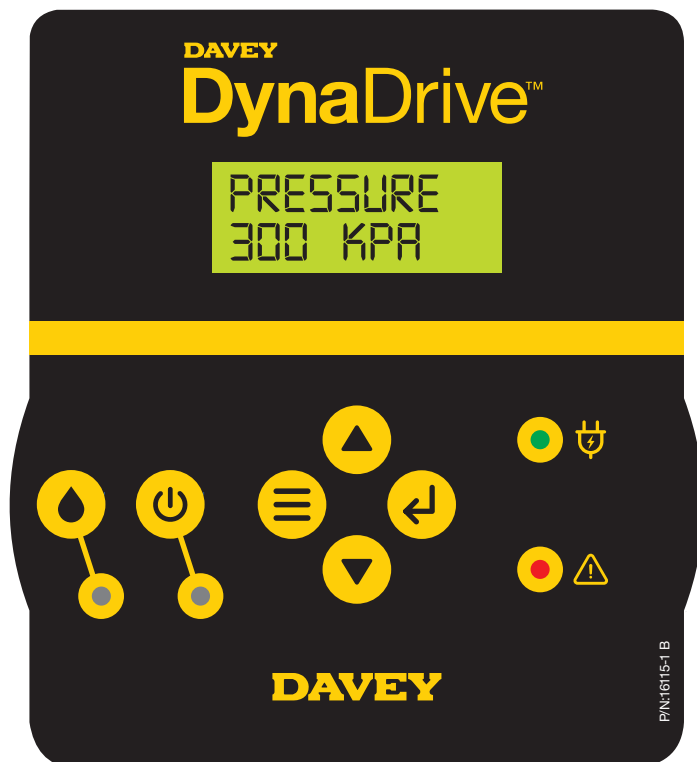

Figure 6.11

- Press ↵ **Enter button**, or ☰ **Menu button** to return to the **HOME SCREEN**, see figure 6.12;

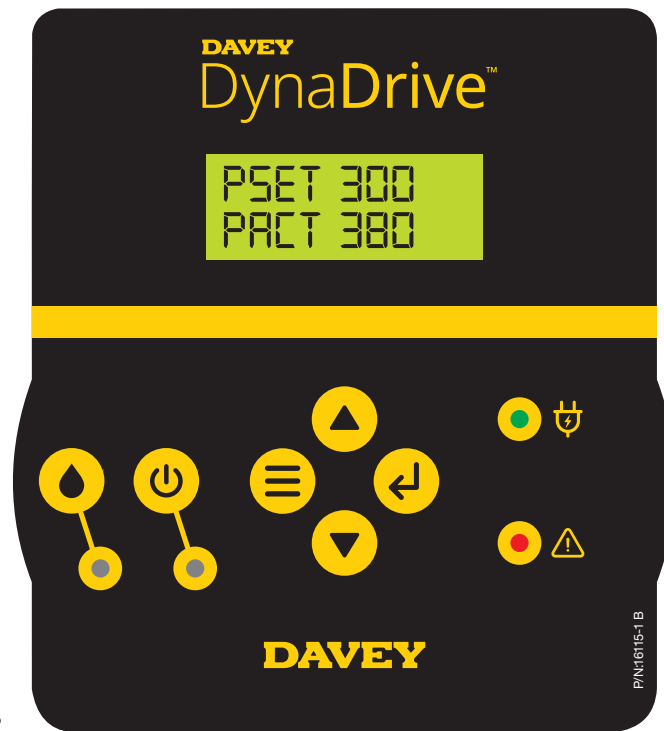

Figure 6.12

- Now restart automatic operation by pressing  Automatic on / manual off button.

6.5 Extra draw-off capacity

The DynaDrive has a pressure tank included as part of the system which will accommodate small leaks. In some applications it may be appropriate to install an additional (or larger) accumulator (pressure tank) capacity. These applications include:

- Long suction lines;
- Low flow appliances connected to the pump, such as evaporative air conditioners, slow filling toilet cisterns, where flows can be a little as 0.5L/min (½ quart).

Any additional accumulators can be installed downstream of the controller (ie. between the controller and the first outlet). Where extra draw-off capacity is utilised the additional pressure tank should have a pre-charge 70% of the system set pressure. For installations requiring flow rates between 125-500mL/min (4 – 17oz/min), it is common for the DynaDrive to run continuously. If this occurs, adjust up the min frequency setting (refer section 7.4) and install a larger pressure tank. If you have any further concerns, please contact your local Davey representative.

6.6 Decommissioning the DynaDrive

Should it become necessary to decommission the DynaDrive to relocate the it, store it, or conduct some service maintenance for example:

- Turn off the power to the DynaDrive and unplug it from electrical supply;
- Close any isolation valves on the suction side of the pump;
- Open a tap, or outlet on the delivery side of the pump and discharge excess pressure in the line;
- Close any isolation valves on the delivery side of the pump;



ATTENTION: It is essential that the system is de-pressurized before proceeding. Failure to do so could result in harm to product &/or user.

- Unscrew the pressure tank from the top of the DynaDrive discharge/delivery outlet. **NOTE:** depending on the installation it is possible that water may spill from the pipework and pressure tank. It would be good practice to prepare for this;
- Unscrew pipework from the DynaDrive discharge/delivery outlet;
- Unscrew pipework from the DynaDrive suction inlet;
- Slide DynaDrive out of location.

7. ADVANCED SETTINGS

7.1 Changing cut-in pressure point

The default cut-in pressure of DynaDrive is 50kPa (7psi) less than set point. This can be changed by:

- Ensure **automated control** is turned off. To turn the automated control off, push the  **Automatic on / manual off button**.

- The green  **Automatic LED** will turn off, see figure 7.1;

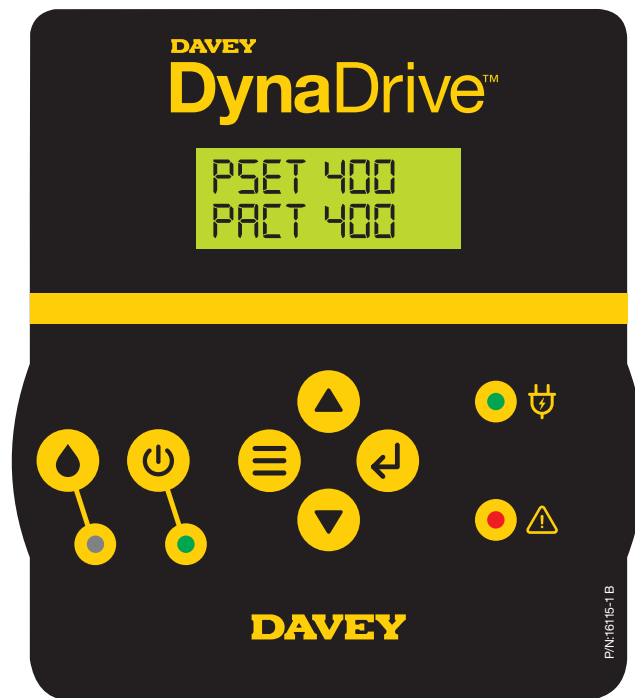



Figure 7.1

- Once the motor has slowed to a stop, press and hold the  **Menu button** and  **Enter button** for ~ 5 seconds. The display will change to show your current set pressure, see figure 7.2;

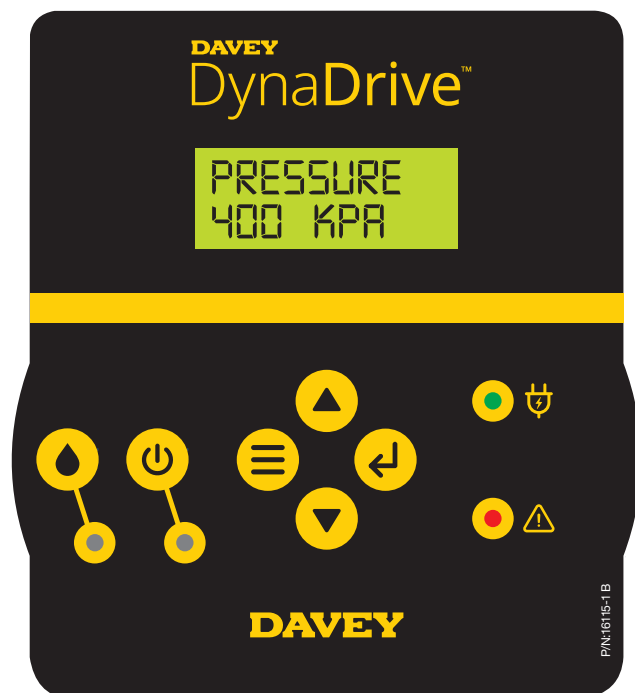

Figure 7.2

- If the controls are untouched for ~ 30 seconds, the menu will revert back to normal display;
- Using the ▲ **Menu up button** and ▼ **Menu down button** scroll through to Cut-in;
- Use the ▲ **Menu up button** and ▼ **Menu down button** to change the setting to adjust the cut-in pressure variance;
- Press the ↵ **Enter button** to save settings and return to the **HOME SCREEN**;
- Now restart automatic operation by pressing ⏻ **Automatic on / manual off button**.

In a daisy-chain installation, the cut-in of the secondary pump occurs after the same pressure drop as the primary pump is set.

7.2 Changing the min frequency

The default minimum frequency of DynaDrive is 15Hz. This can be changed by:

- Ensure **automated control** is turned off. To turn the automated control off, push the ⏻ **Automatic on / manual off button**.
- The green ⏻ **Automatic LED** will turn off, see figure 7.3;

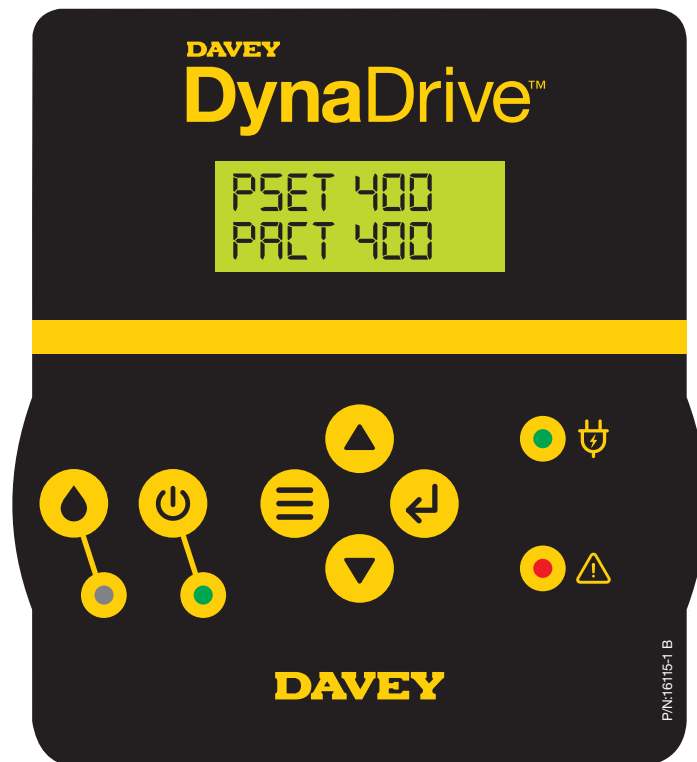

Figure 7.3

- Once the motor has slowed to a stop, press and hold the ≡ **Menu button** and ↵ **Enter button** for ~ 5 seconds. The display will change to show your current set pressure, see figure 7.4;

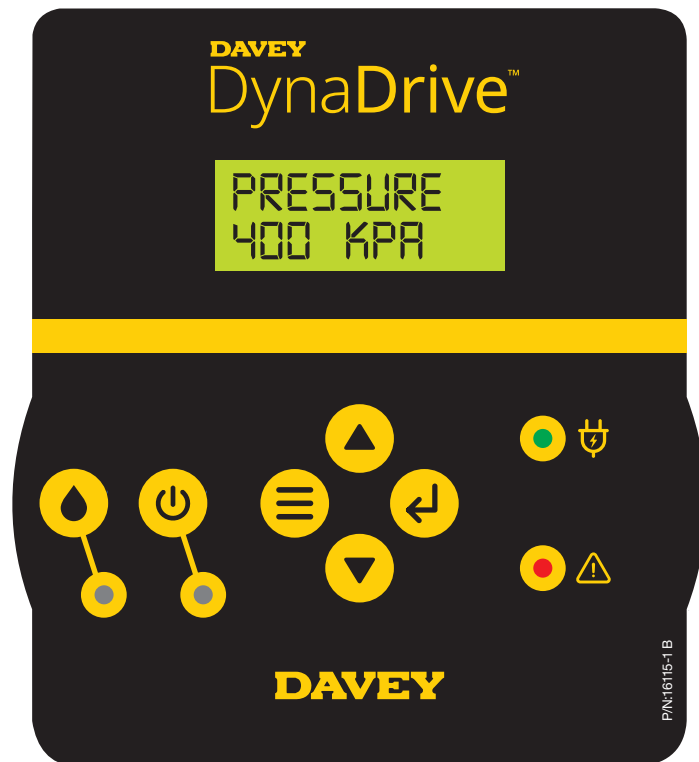
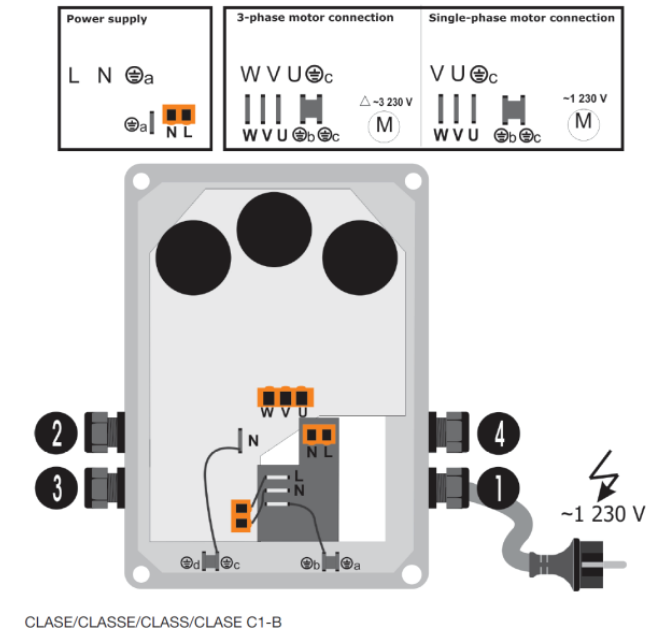

Figure 7.4

- If the controls are untouched for ~ 30 seconds, the menu will revert back to normal display;
- Using the ▲ **Menu up button** and ▼ **Menu down button** scroll through to Min Freq.
- Use the ▲ **Menu up button** and ▼ **Menu down button** to change the setting to. The setting will change by 5Hz;
- Press the ↵ **Enter button** to save settings and return to the HOME SCREEN;
- Now restart automatic operation by pressing ⏻ **Automatic on / manual off button**.

7.3 Using a switch to override DynaDrive operation

DynaDrive has the ability to be overridden by a separate switch. This may be of benefit if using a float switch on a source tank (eg rainwater tank). To wire in an independent switch, refer figure 7.5 and 7.6.



- WIRING - CABLAGGIO - CABLEADO-
CÂBLAGE
- 1** Power supply
 - 2** Pressure transmitter
 - 3** Pump connection single-phase pumps
 - 4** O- Master&Slave communications cable
- Minimal level (optional)

Figure 7.5

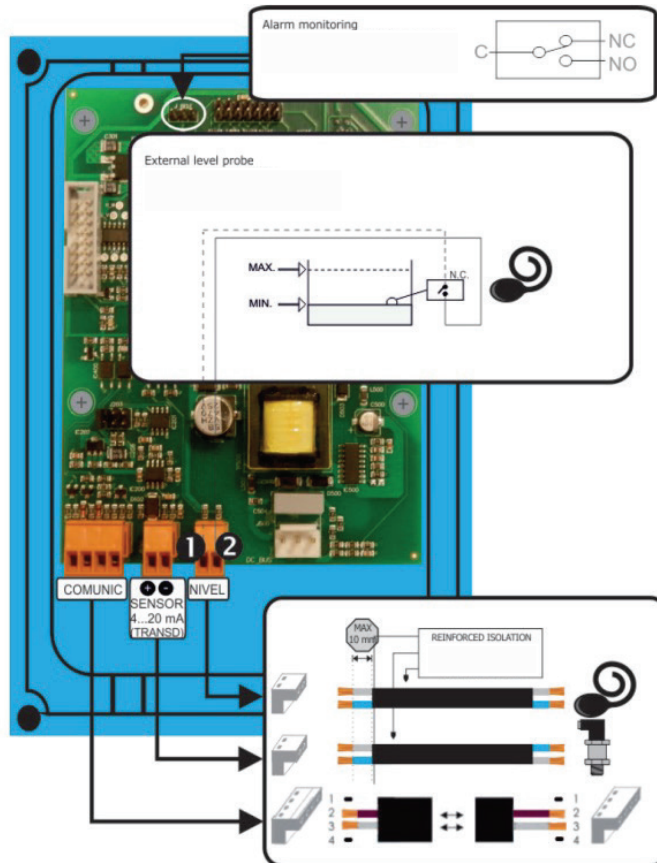



Figure 7.6

To set the DynaDrive to recognize the remote switch:

- Ensure **automated control** is turned off. To turn the automated control off, push the  **Automatic on / manual off button**.

- The green  **Automatic LED** will turn off, see figure 7.7;

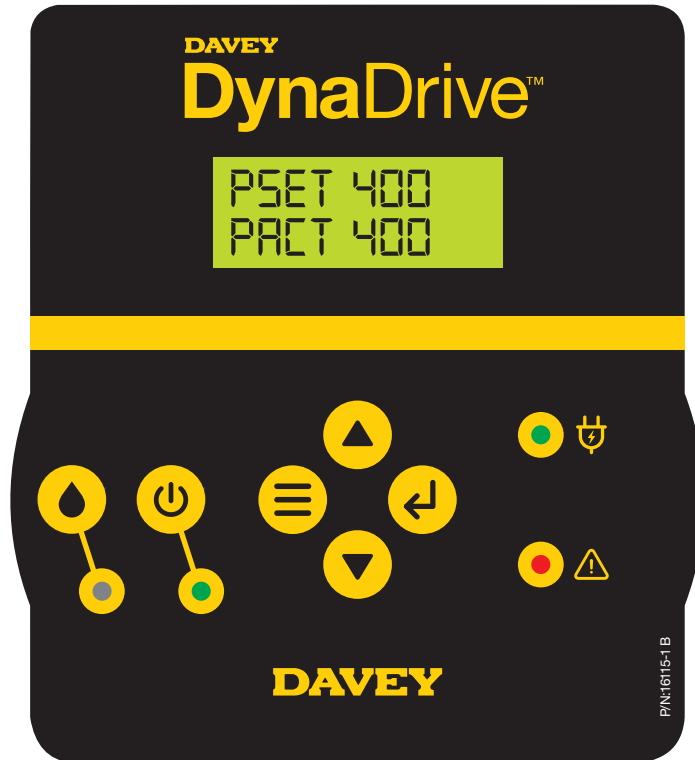



Figure 7.7

- Once the motor has slowed to a stop, press and hold the  **Menu button** and  **Enter button** for ~ 5 seconds. The display will change to show your current set pressure, see figure 7.8;

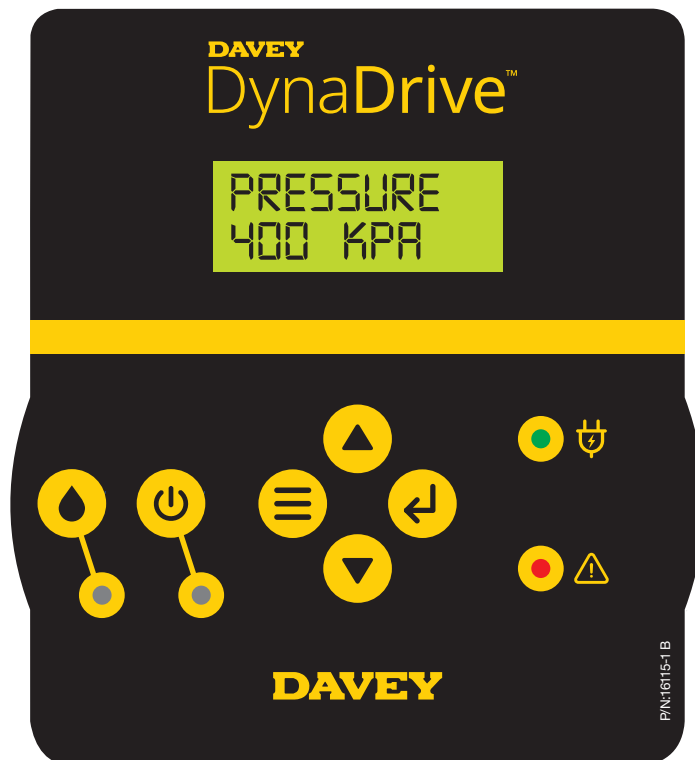

Figure 7.8

- If the controls are untouched for ~ 30 seconds, the menu will revert back to normal display;
- Using the ▲ **Menu up button** and ▼ **Menu down button** scroll through to LEVEL;
- Use the ▲ **Menu up button** and ▼ **Menu down button** to change the setting to Y;
- Press the ↵ **Enter button** to save settings and return to the HOME SCREEN;
- Now restart automatic operation by pressing ⏻ **Automatic on / manual off button**.

Once the menu has been changed to acknowledge the external float, the external float can be wired into the DynaDrive controller. The normally open terminals will not trigger fault/alarm/pause conditions. When the terminals are closed circuit, the DynaDrive operates normally. Davey recommends a float switch cable no longer than 3m (10 feet), when using 2 x 0.25mm (24 AWG) cable. If the switch overrides DynaDrive to pause, the DynaDrive display will show a flashing ●⚠ **Fault LED**.

The ⏻ **Automatic LED** will also flash on the control display, see figure 7.9.

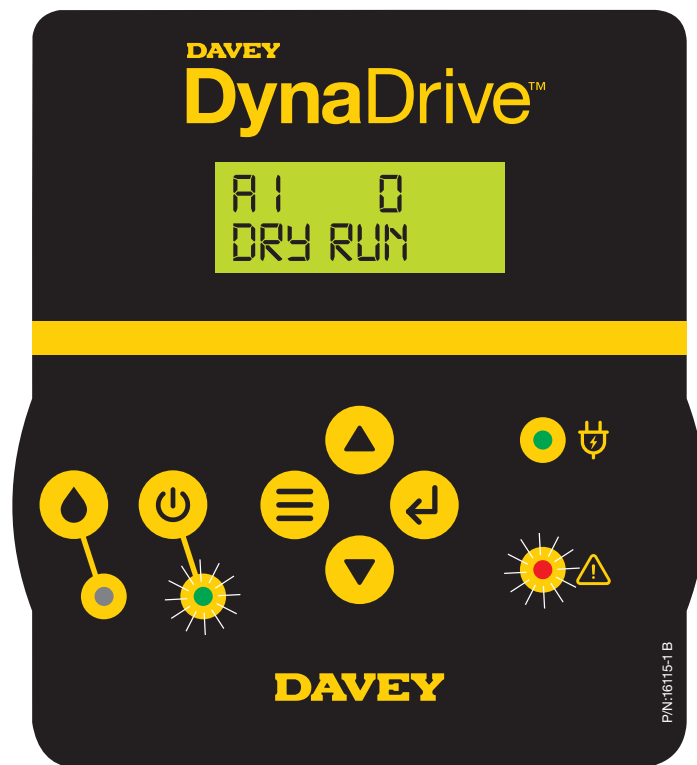

Figure 7.9

Once the switch is reversed, for example the rainwater tank filling again, the DynaDrive will restart and the display will return to normal.

7.4 Daisy-chain multiple DynaDrive systems

It is possible to run two DynaDrive pumps in parallel, with a shared discharge line. This can be particularly useful in applications where the system's maximum flow rate can be significantly higher than the system's minimum flow rate. For example: if DynaDrive needed a flow rate demand of up to 140L/min (37 gallons/min) at a pressure of 400kPa. Running two DynaDrive DD90-11 systems in parallel with common discharge would accommodate this. One DynaDrive would be designated as the MASTER, with the remaining DynaDrive designated as a SLAVE. Each DynaDrive would require its own pressure transducer. When making changes to settings in the system, only the MASTER can be adjusted.

On initial startup, the DynaDrive designated as the MASTER will be the first pump to start. The SLAVE DynaDrive will come on if the first pump is unable to maintain set pressure, even when running at 100% speed. The next time water is in demand, the SLAVE pump will come on first. This sequence is referred to as auto-rotate. To wire up the MASTER and SLAVE pump, refer figure 7.10.

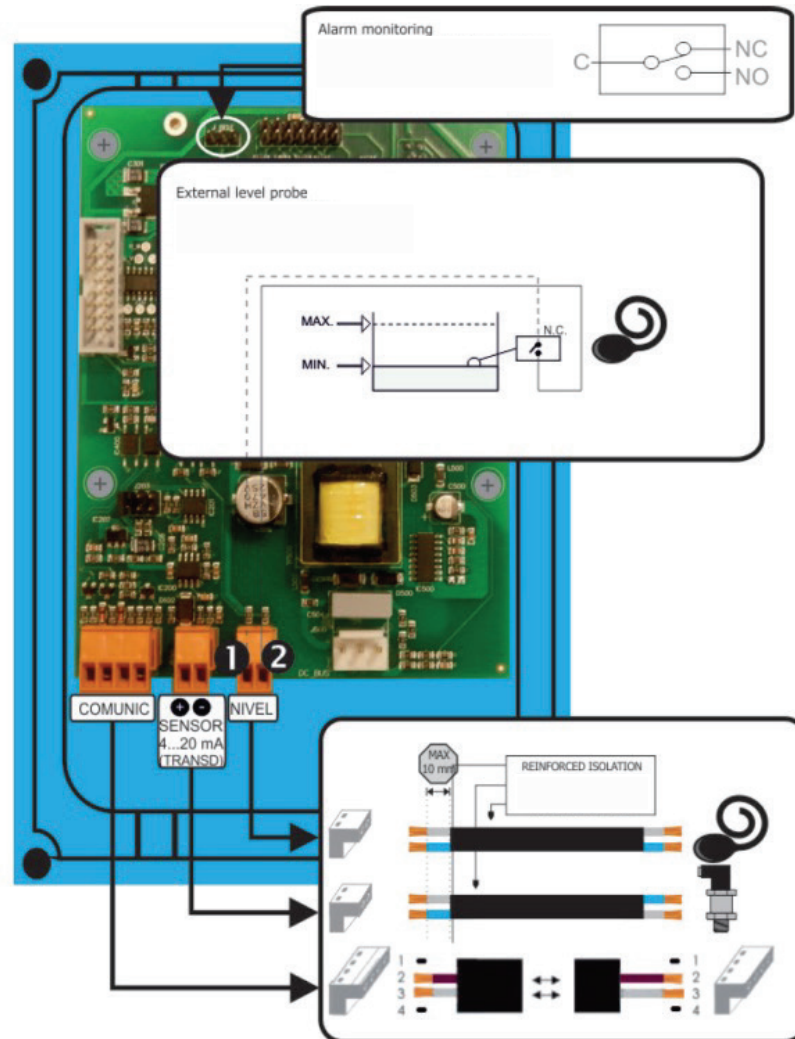











Figure 7.10

The connection between the DynaDrive controllers requires 2 x 0.25mm (24 AWG) cable. From one DynaDrive, use the “COMUNIC” terminal 2. Wire to the “COMUNIC” terminal 2 of the second DynaDrive. To complete the circuit, from one DynaDrive, use the “COMUNIC” terminal 3. Wire to the “COMUNIC” terminal 3 of the second DynaDrive. Davey suggests limiting the distance between the pumps to 2m (6½ feet). To set up multiple DynaDrive to run in a common manifolded system use the following:

To set the DynaDrive to recognise the daisy chain configuration:

- Ensure **automated control** is turned off. To turn the automated control off, push the  **Automatic on / manual off button**.
- The green  **Automatic LED** will turn off, see figure 7.8;

- Once the motor has slowed to a stop, press and hold the  **Menu button** and  **Enter button** for ~ 5 seconds. The display will change to show your current set pressure, see figure 7.9;
- If the controls are untouched for ~ 30 seconds, the menu will revert back to normal display;
- Using the  **Menu up button** and  **Menu down button** scroll through to TYPE;
- Use the  **Menu up button** and  **Menu down button** to change the setting from SINGLE to MASTER;
- Press the  **Enter button** to save settings and return to the HOME SCREEN;
- Repeat this process with the other pump in the system, selecting SLAVE;
- Now restart automatic operation by pressing  **Automatic on / manual off button**.

8. TECHNICAL SPECIFICATIONS

8.1 Operating limits

	DD60-10(CE/NPT)	DD90-11 (CE/NPT)
Max flow rate @ 300kPa (43psi)	60L/min (16 US gallons)	92L/min (24 US gallons)
Max flow rate @ 400kPa (58psi)	48L/min (13 US gallons)	72L/min (19 US gallons)
Max flow rate @ 500kPa (73psi)	32L/min (8 US gallons)	35L/min (9 US gallons)
Maximum casing pressure	1,000kPa (145psi)	
Maximum set pressure	600kPa (87psi)	
Minimum cut-in pressure (gauge)	10kPa (1½psi)	
Default cut-in pressure	50kPa (7psi) less than set pressure	
Maximum cut-in pressure	20kPa (3psi) less than set pressure	
Operating water temp range	0 – 80°C (32 - 176°F)	
Operating ambient/air temp range	0 – 50°C (32 - 122°F)	
Max humidity	95%	
Nature of fluids	Clean, clear, non-corrosive, non-flammable liquids with no fibers and little sand/ silica or abrasives (maximum concentration 40g/m ³).	
Applicable approvals (DD60-10 & DD90-11)	UNE-EN 55014-1; UNE-EN 61000-3-2; UNE-EN61000-3-3; UNE-EN 55014-2; IEC 60335-2- 41; IEC 60335-1 + A1 + A2; AS/NZS 60335.2.41; ASNZS 60335.1 + A1 + A2 + A3 + A4; AS4020	
Applicable approvals (DD60-10CE & DD90-11CE)	EN 60335-2-41 + A1 + A2 EN 60335-1 + A11 + A13 EN 62233	
Applicable approvals (DD60-10NPT & DD90-11NPT)	UL 778; UL61800-5-1; CSA-C22.2 No. 108-14	

8.2 Hydraulic performance

	DD60-10	DD60-10CE	DD60-10NPT	DD90-11	DD90-11CE	DD90-11NPT
Inlet	1¼" BSP F	1¼" NPT F	1¼" NPT F	1¼" BSP F	1¼" NPT F	1¼" NPT F
Discharge outlet	1" BSP M	1" NPT M	1" NPT M	1" BSP M	1" NPT M	1" NPT M
Default nominal operating pressure	400kPa (58psi)	60psi	60psi	400kPa (58psi)	60psi	60psi
Number of stages (impellers)	6			5		
Maximum pump pressure (head)	69m (226')			59m (194')		
Pressure tank outlet	1" BSP M	N/A	N/A	1" BSP M	N/A	N/A
Tank pre-charge (default)	280kPa (41psi)	N/A	N/A	280kPa (41psi)	N/A	N/A

Figure 8.1

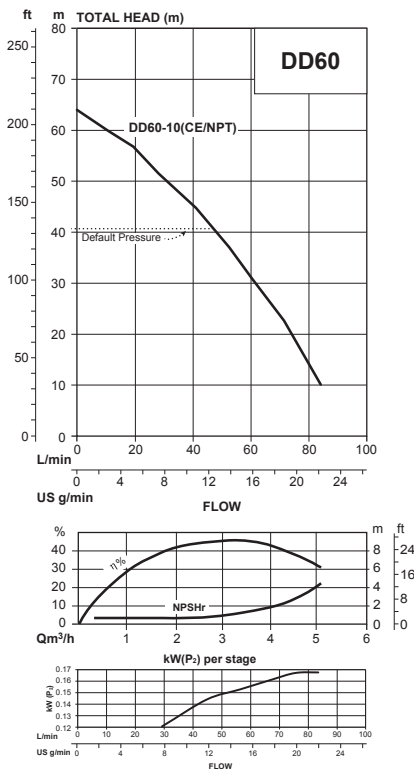
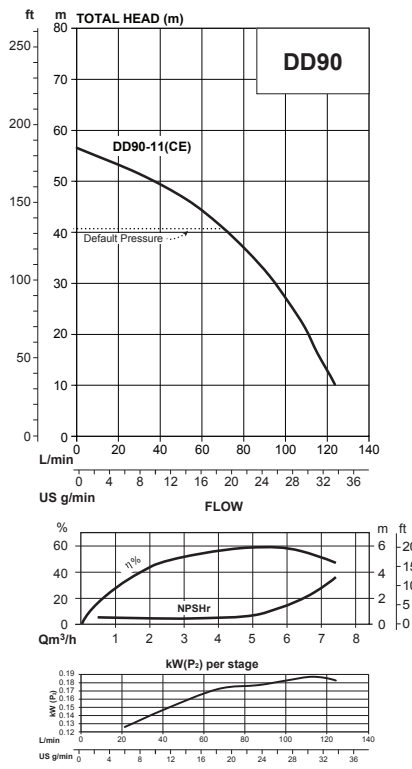

Figure 8.2



8.3 Dimensions

DD60-10

DD90-11

A	175mm (6 7/8")
B	598mm (23 1/2")
C	307mm (12")
D	149mm (5 7/8")
E	102mm (4")
F	251mm (9 7/8")
G	130mm (5 1/8")
H	258mm (10 1/8")
I	461mm (18 1/8")

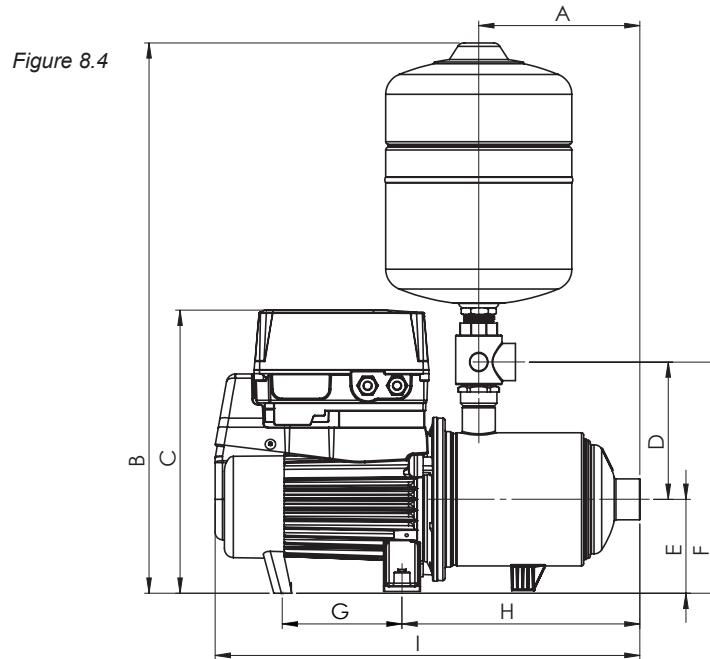

8.4 Electrical data

	DD60-10(CE/NPT)	DD90-11 (CE/NPT)
Voltage	220 – 240V ~	
Max motor speed	2,900rpm	
Frequency (incoming power)	50 – 60Hz	
Input power (P₁)	1.1kW	1.3kW
Output power (P₂)	0.8kW	0.9kW
Running current	7.4A	8.6A
Insulation class	F	
IP rating	55	

8.5 Materials of construction

PART	MATERIAL
Casing	304 stainless steel
Impellers	304 stainless steel
Stages (casing)	304 stainless steel
Pump shaft	316 stainless steel
Stage centring device	304 stainless steel

Mechanical seal (rotating)	Carbon
Mechanical seal (stationary)	Ceramic
Mechanical seal (spring)	316SS
Mechanical seal (bellows)	EPDM
O-rings	EPDM
Plugs	316 stainless steel
Motor shell and lantern bracket	Aluminium with baked polyester powder coat finish
Motor feet	Xenoy
Fan cowl/rear foot (DD60-10, DD90-11)	Polypropylene
Adaptor VSD	Polypropylene
5-way tee piece	304 stainless steel
Pump coupling to 5-way tee piece	304 stainless steel
Bearings	C3 greased and sealed for life

10. MAINTENANCE



ATTENTION: Automatic resets may allow the pump to restart without warning. Always disconnect the pump motor from the electrical supply before maintenance or repairs. When servicing or attending pump and/or controllers, always ensure power is switched off and lead unplugged. Electrical connections should be serviced only by qualified persons. If the electrical supply lead of this pressure system is damaged, it must be replaced by the manufacturer, or an appointed representative. Under no circumstances should the DynaDrive be disassembled by other than qualified tradespersons. Failure to observe this warning may expose persons to the possibility of personal injury and may also result in damage to other property. Do not dismantle spring under pressure.



IMPORTANT: Do not use hydrocarbon based or hydrocarbon propelled sprays around the electrical components of this pump. During servicing, use only approved, non-petrochemical based o-ring and gasket lubrication. If unsure, consult your Davey representative for advice. For protection, DynaDrive monitors input current and will shut down the pump motor in the event of an over load.

10.1 Periodic pressure tank checks

Depending on the quality of the pumped water, from time to time your tank may require flushing to remove settled fines such as mud or sand. If sand, or mud can stay in the tank it will accelerate wear on the internal lining and shorten your tanks life. Safely disconnect the tank from the water supply, discharge all air from the tank and flush the tank several times with clean water. Once the flushing water is clean, reconnect the tank and recharge the air as described in the pressure tank section of the installation chapter.

A tank in good order will not leak, but over time due to damage through rough handling, impacts or grit and/or impurities in the water the tank shell may fail and/or leak. Should the tank leak or show signs of possible failure the tank should be immediately disconnected and replaced.

11. TROUBLESHOOTING

Symptom	Potential Fix
<ul style="list-style-type: none"> • Fault light flashes on DynaDrive display; • “A1 DRY RUN” shows on DynaDrive display; • DynaDrive attempts restart after 5 minutes; • DynaDrive attempts restart in 30 minutes intervals, for 25 hours; • DynaDrive then reverts to solid alert with no further retry. 	<p>DynaDrive has run dry or lost prime. To protect itself, DynaDrive has switched off. Before trying to restart: turn off the DynaDrive for 30 seconds; ensure the pump has cooled down (if hot); then restart as per section 6 of this manual. If problem persists, contact your Davey representative via the details at the end of this manual.</p>
<ul style="list-style-type: none"> • Fault light flashes on DynaDrive display; • “A9 UNDER VOL” shows on DynaDrive display; • DynaDrive attempts restart 4 times; then • DynaDrive reverts to solid alert with no further retry. 	<p>DynaDrive has detected low voltage, or high current draw. To protect itself, DynaDrive has switched off. Before trying to restart: turn off the DynaDrive for 30 seconds; ensure the pump has cooled down (if hot); then restart as per section 6 of this manual. If problem persists, contact your Davey representative via the details at the end of this manual.</p>
<ul style="list-style-type: none"> • Fault light flashes on DynaDrive display; • “A8 OVER VOL” shows on DynaDrive display; and • DynaDrive attempts random restarts. 	<p>DynaDrive has detected high voltage. To protect itself, DynaDrive has switched off. Before trying to restart: turn off the DynaDrive for 30 seconds; ensure the pump has cooled down (if hot); then restart as per section 6 of this manual. If problem persists, contact your Davey representative via the details at the end of this manual.</p>
<ul style="list-style-type: none"> • Fault light flashes on DynaDrive display; • “A6 OVER TEMP” shows on DynaDrive display; and • DynaDrive attempts random restarts. 	<p>DynaDrive has detected high temperature inside controller. To protect itself, DynaDrive has switched off. Before trying to restart: turn off the DynaDrive for 30 seconds; ensure the pump has cooled down (if hot); then restart as per section 6 of this manual. If problem persists, contact your Davey representative via the details at the end of this manual.</p>
<ul style="list-style-type: none"> • DynaDrive display screen blank. 	<p>DynaDrive communication failure. Refer to section 7.4 of this manual to check connections and settings. If problem persists, contact your Davey representative via the details at the end of this manual.</p>
<ul style="list-style-type: none"> • Daisy chained pumps operating as individual pumps. 	<p>DynaDrive communication failure. Refer to section 7.4 of this manual to check connections and settings. If problem persists, contact your Davey representative via the details at the end of this manual.</p>
<ul style="list-style-type: none"> • “A5 TRANSDU” 	<p>Transducer is disconnected from the Drive. Reconnect the pressure transducer to the quick connect cable attached to the pump.</p>

12. SPARE PARTS

DynaDrive 6 stages	DD60-10(CE)	DD60-10NPT
DynaDrive 5 stages	DD90-11(CE)	DD90-11NPT

Notes: A. 2nd Stage body comes with air valve assy which can be retrofitted onto models without the air valve. Subsequent stage bodies have the air hole which can also be retrofitted onto models that do not have the air valve already fitted.
 B. Washer cup part number 13666 - quantity of 1 required for HM60 & HM90 models (fitted to drive end side only).
 C. Tank is optional extra for CE and NPT model variants

Figure 11.1

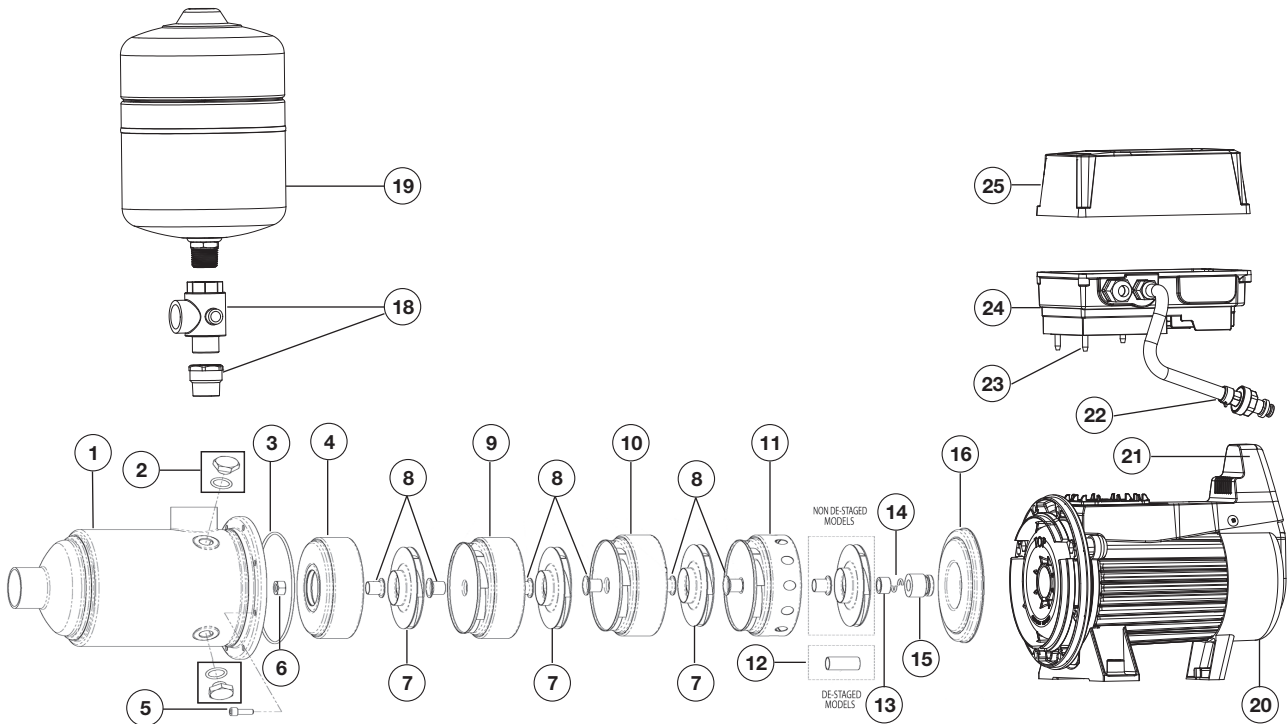

ITEM	NOTES	DESCRIPTION	QTY REQ'D	PART NO.
1		Casing - Front DD60-10(CE), DD90-11(CE)	1	13656-6SP
1		Casing - Front DD60-10NPT, DD90-11NPT	1	13656-6USA
2		Plug & O-ring - 1/4" BSP Vertical	3	400577SP
3		O-ring - Casing	1	44853
4		Stage body - 1st stage	1	13661-1
5		Screw - Casing (pk8)	1	S34M0616*8
6		Nut - Casing 6mm s/s	1	N33M10*6
6		Nut - Half	1	401573
7		Impeller DD60 series	As required	13678
7		Impeller DD90 series	As required	13676
8		Spacer - Impeller	As required	13665
9	A	Stage Body - 2nd stage with valve assy	1	32912

Cont. overleaf...

ITEM	NOTES	DESCRIPTION	QTY REQ'D	PART NO.
10		Stage body - Inner stages	As required	13662-2
11		Stage body - Final	1	13663
12		Spacer - Destage	1	13696-1
13	B	Washer - Cup	As required	13666
14		Clip spring	2	13667
15		Seal - Mechanical	1	400558SP
16		Backplate	1	13660
19		8L pressure tank DD60-10(CE), DD90-11(CE)	1	24008P
20		Fan cowl DD60-10(CE), DD90-11(CE)	1	11150-40M
20		Fan cowl DD60-10NPT, DD90-11NPT	1	11150-40MNPT
21		VSD adaptor DD60-10(CE), DD90-11(CE)	1	16098
21		VSD adaptor DD60-10NPT, DD90-11NPT	1	16098-1
22		Pressure transducer & loom	1	RECH092SP
23		O-ring to suit adaptor VSD	1	402442
24		DynaDrive power module DD60-10(CE), DD90-11(CE)	1	RECH092345SP
24		DynaDrive power module DD60-10NPT, DD90-11NPT	1	TBC
25		DynaDrive control module DD60-10(CE), DD90-11(CE)	1	RECH091SP
25		DynaDrive control module DD60-10NPT, DD90-11NPT	1	TBC
-		Slinger - Water	1	13648

13. Davey Warranty

13.1 Warranty Inside the USA

Davey Water Products come with guarantees that cannot be excluded under the local country Law. You are entitled to a replacement, or refund for a major failure and compensation for any other reasonably foreseeable loss, or damage. You are also entitled to have the goods repaired or replaced if the goods fail to be of acceptable quality and the failure does not amount to a major failure.

Davey Water Products Pty Ltd (Davey) of 6 Lakeview Drive Scoresby VIC 3179 provides the following warranty in relation to this product:

1. The guarantee period commences on either the date of installation or the original purchase of the equipment (whichever is the later). Evidence of this date must be provided when claiming repairs under guarantee. It is recommended you retain all receipts in a safe place.
2. Davey products are warranted, subject to the exclusions and limitations below, to the original user only to be free of defects in material and workmanship for a period of 36 months from date of installation or sale with a proof of a receipt, but no more than 48 months from the date of manufacture. Davey's liability under this warranty shall be limited to repairing or replacing at Davey's option, without charge, FOB Davey's authorized service agent. Davey will not be liable for any cost of removal, installation, transport or any other charges that may arise in connection with the warranty claim. Product eligible for repair or replacement by the authorized Davey service agent, in accordance with Davey's warranty terms, shall be shipped back to the customer from the service center at Davey's cost.
3. This guarantee is subject to due compliance by the original purchaser with all directions and conditions set out in the Installation and Operating Instructions. Failure to comply with these instructions, damage or breakdown caused by fair wear and tear, negligence, misuse, accident, incorrect installation, inappropriate chemicals or additives in the water, inadequate protection against freezing, rain or other adverse weather conditions, corrosive or abrasive water, lightning or high voltage spikes or through unauthorized persons attempting repairs are not covered under guarantee. The product must only be connected to the voltage shown on the nameplate.
4. Davey shall not be liable for any loss of profits or any consequential, indirect or special loss, damage or injury of any kind whatsoever arising directly or indirectly from the product or any defect, and the purchaser shall indemnify Davey against any claim by any other person whatsoever in respect of any such loss, damage or injury.
5. Some states do not allow the exclusion or limitation of incidental or consequential damages or limitations on how long an implied warranty lasts, so the above limitations or exclusions may not apply to you. The warranty gives you specific legal rights and you may also have other rights which vary from state to state.
6. This guarantee applies to all states and territories of United States of America and Canada only.

® Davey and Torrium are registered trademarks of Davey Water Products Pty Ltd.

© Davey Water Products Pty Ltd 2020.

USA

Have installation questions or problems?

Need warranty?

Before returning this product to your dealer contact a Davey Authorized Service Centre in the USA by calling

866.328.7867 or visit daveywater.com

13.2 Warranty Outside the USA

Davey Water Products Pty Ltd (Davey) warrants all products sold will be (under normal use and service) free of defects in material and workmanship for a minimum period of one (1) year from the date of original purchase by the customer as marked on the invoice, for specific warranty periods for all Davey products visit daveywater.com.

This warranty does not cover normal wear and tear or apply to a product that has:

- been subject to misuse, neglect, negligence, damage or accident
- been used, operated or maintained other than in accordance with Davey's instructions
- not been installed in accordance with the Installation Instructions or by suitably qualified personnel
- been modified or altered from original specifications or in any way not approved by Davey
- had repairs attempted or made by other than Davey or its authorised dealers
- been subject to abnormal conditions such as incorrect voltage supply, lightning or high voltage spikes, or damages from electrolytic action, cavitation, sand, corrosive, saline or abrasive liquids,

The Davey warranty does not cover replacement of any product consumables or defects in products and components that have been supplied to Davey by third parties (however Davey will provide reasonable assistance to obtain the benefit of any third-party warranty).

To make a warranty claim:

- If the product is suspected of being defective, stop using it and contact the original place of purchase. Alternatively, phone Davey Customer Service or send a letter to Davey as per the contact details below
- Provide evidence or proof of date of original purchase
- If requested, return the product and/or provide further information with respect to the claim. Returning the product to the place of purchase is at your cost and is your responsibility.
- The warranty claim will be assessed by Davey on the basis of their product knowledge and reasonable judgement and will be accepted if:
 - o a relevant defect is found
 - o the warranty claim is made during the relevant warranty period; and
 - o none of the excluded conditions listed above apply
- The customer will be notified of the warranty decision in writing and if found to be invalid the customer must organise collection of the product at their expense or authorise its disposal.

If the claim is found to be valid Davey will, at its option, repair or replace the product free of charge.

The Davey warranty is in addition to rights provided by local consumer law. You are entitled to a replacement or refund for a major failure and compensation for any other reasonably foreseeable loss or damage. You are also entitled to have the goods repaired or replaced if the goods fail to be of acceptable quality and the failure does not amount to a major failure.

For any internet connected products the consumer is responsible for ensuring a stable internet connection. In the event of a network failure the consumer will need to address the concern with the service provider. Use of an App is not a substitute for the User's own vigilance in ensuring the product is working to expectation. Use of a Smart Product App is at the User's own risk. To the fullest extent permitted by law Davey disclaims any warranties regarding the accuracy, completeness or reliability of App data. Davey is not responsible for any direct or indirect loss, damage or costs to the User arising from its reliance on internet connectivity. The User indemnifies Davey against any claims or legal actions from them or others relying on internet connectivity or App data may bring in this regard.

Products presented for repair may be replaced by refurbished products of the same type rather than being repaired. Refurbished parts may be used to repair the products. The repair of your products may result in the loss of any user-generated data. Please ensure that you have made a copy of any data saved on your products.

To the fullest extent permitted by law or statute, Davey shall not be liable for any loss of profits or any consequential, indirect or special loss, damage or injury of any kind whatsoever arising directly or indirectly from Davey products. This limitation does not apply to any liability of Davey for failure to comply with a consumer guarantee applicable to your Davey product under local laws and does not affect any rights or remedies that may be available to you under local laws.

For a complete list of Davey Dealers visit our website (daveywater.com) or call:

DAVEY

Davey Water Products Pty Ltd
Member of the GUD Group
ABN 18 066 327 517

daveywater.com

AUSTRALIA

Head Office

6 Lakeview Drive,
Scoresby, Australia 3179
Ph: 1300 232 839
Fax: 1300 369 119
Email: sales@davey.com.au

NEW ZEALAND

7 Rockridge Avenue,
Penrose, Auckland 1061
Ph: 0800 654 333
Fax: 0800 654 334
Email: sales@dwp.co.nz

EUROPE

ZAC des Gaulnes
355 Avenue Henri Schneider
69330 Meyzieu, France
Ph: +33 (0) 4 72 13 95 07
Fax: +33 (0) 4 72 33 64 57
Email: info@daveyeurope.eu

NORTH AMERICA

Ph: 1-877-885-0585
Email: info@daveyusa.com

MIDDLE EAST

Ph: +971 50 6368764
Fax: +971 6 5730472
Email: info@daveyuae.com