

290-5 (B39)

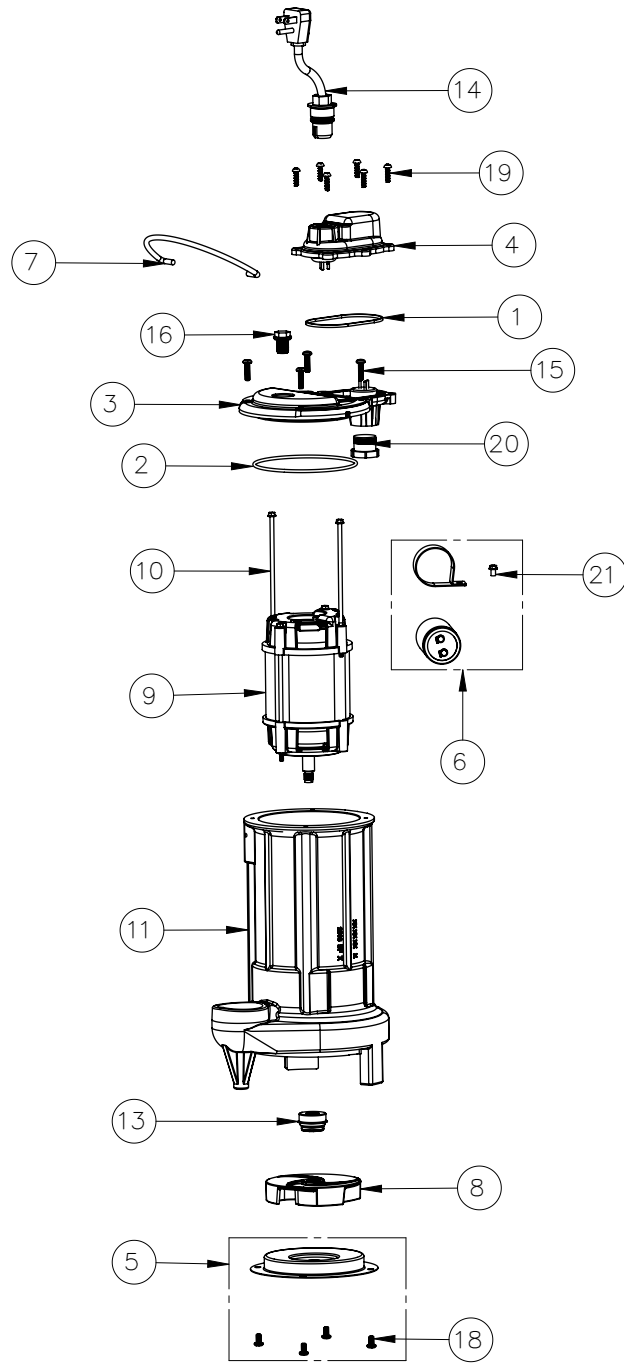

290-5 (B39)

#	PART #	DESCRIPTION	QTY	Note
1	K001046	SEALRING, CHAMBER COVER	1	
2	2357000	O-RING	1	[1]
3	240600B	MOTOR COVER	1	
4	240700B	CHAMBER COVER	1	
5	K001349	290 SERIES STAMPING INLET KIT	1	
6	K001350	CAPACITOR KIT	1	
7	K001082	HANDLE	1	
8	K001351	290 SERIES IMPELLER KIT	1	
9	2425200	115V 2-POLE MOTOR	1	[1]
10	2904E20	8-32 SCREW 5.688	2	
11	290300J	CAST IRON HOUSING	1	[1]
13	50980A0	1/2 INCH UNITIZED SEAL	1	[1]
14	K001345	POWER CORD, 50FT.	1	
15	8072000	#10 - 24 x 3/4" SCREW	4	
16	8089000	OIL PLUG, O-RING ASSEMBLY	1	
18	8092000	#10 - 24 x 3/8" SCREW	4	
19	8104200	#10 HILO X 5/8" STAINLESS STEEL SCREW	6	
20	8105000	PROTECTIVE CAP	1	
21	8160000	CAPACITOR SCREW	1	
22	LPOILT1032OZ	REPLACEMENT T10 OIL, QUART BOTTLE (REF 8504000)	1	[2]

PART NOTES:

- [1] - Part requires factory authorized service. Contact Liberty Pumps at 1-800-543-2550
 [2] - Acceptable for use in all liberty Pump's oil-filled products

Acceptable for use in all liberty Pump's oil-filled products