

1102/LEH154M (B10)

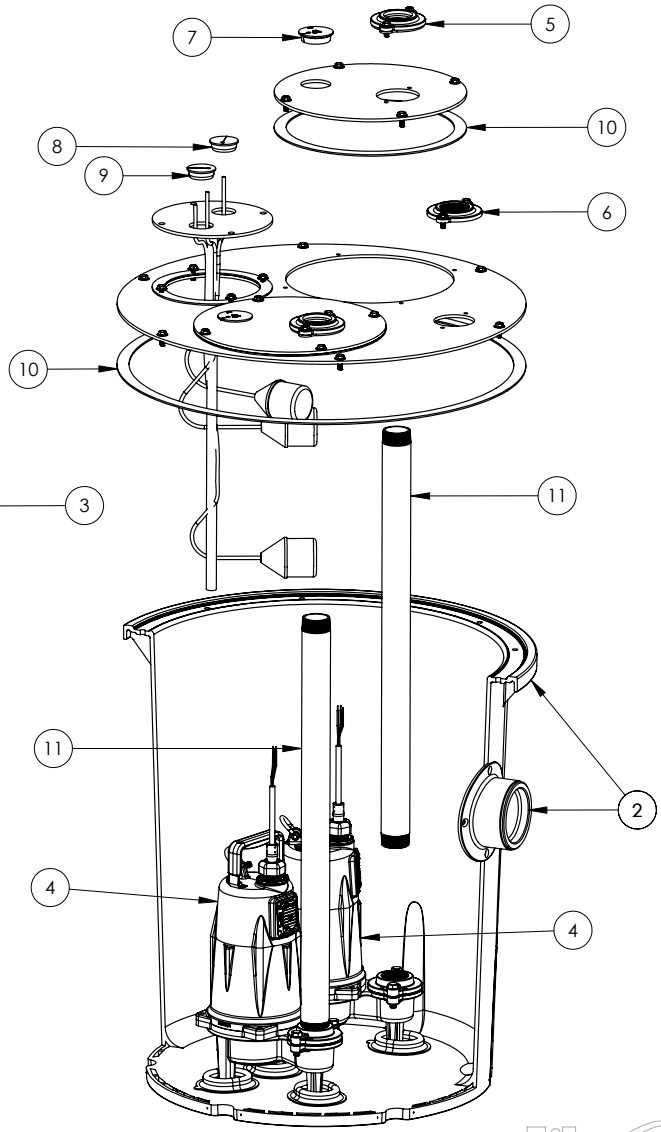
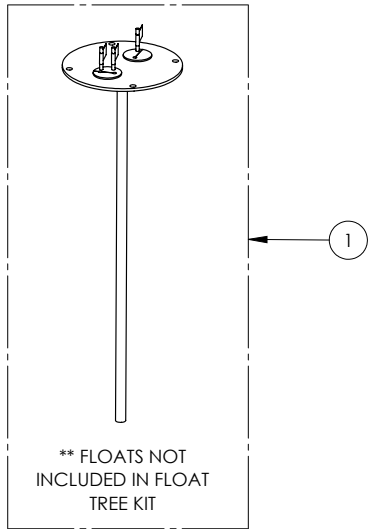
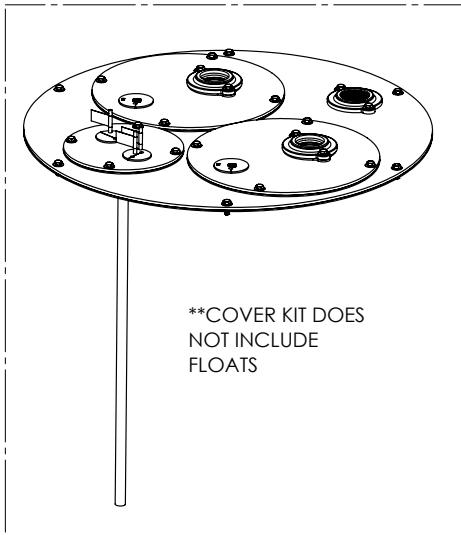

1102/LEH154M (B10)

#	PART #	DESCRIPTION	QTY	Note
1	K001203	10" INSPECTION COVER WITH FLOAT TREE (FLOATS NOT INCLUDED)	1	
2	K001202	30" X 36" BASIN, WITH CAST IRON INLET HUB	1	
3	K001200	1100 COVER KIT 2" DISCH 2" VENT	1	
4	LEH154M2-2	1.5 HP SEWAGE PUMP 440-480V 25' POWER CORD	2	
6	K001390	2" VENT FLANGE KIT	1	
5	K001389	2" DISCHARGE FLANGE KIT	2	
7	4508000	2 1/2" STOPPER - SINGLE 5/16" HOLE	2	
8	45480A0	SINGLE HOLE STOPPER	1	
9	45480B0	2" DOUBLE HOLE STOPPER	1	
10	45220C0	GASKET TAPE	1	
11	4068000	NIPPLE 2x36 PVC SCH 80	2	