

PRODUCT INFORMATION PACKET



Model No: M6C17FC181A

Catalog No: 117881.00

..1HP..1800RPM.56C.TEFC.115/230V.1PH.60HZ.CONT.40C.1.15SF.C-FACE.....IND-AG.....

Agricultural



Regal and Leeson are trademarks of Regal Beloit Corporation or one of its affiliated companies.

©2018 Regal Beloit Corporation, All Rights Reserved. MC017097E





Nameplate Specifications

Output HP	1 Hp	Output KW	0.75 kW
Frequency	60 Hz	Voltage	115/208-230 V
Current	13.4/6.8-6.7 A	Speed	1725 rpm
Service Factor	1.15	Phase	1
Efficiency	72 %	Duty	Continuous
Insulation Class	B	Design Code	N
KVA Code	J	Frame	56C
Enclosure	Totally Enclosed Fan Cooled	Overload Protector	Manual
Ambient Temperature	40 °C	Drive End Bearing Size	6203
Opp Drive End Bearing Size	6203	UL	Recognized
CSA	Y	CE	N
IP Code	43		

Technical Specifications

Electrical Type	Capacitor Start Induction Run	Starting Method	Across The Line
Poles	4	Rotation	Selective Counterclockwise
Mounting	Round	Motor Orientation	HORIZONTAL
Drive End Bearing	BALL	Opp Drive End Bearing	BALL
Frame Material	Rolled Steel	Shaft Type	T
Overall Length	12.82 in	Frame Length	7.56 in
Shaft Diameter	0.625 in	Shaft Extension	1.88 in
Assembly/Box Mounting	F1 ONLY		
Outline Drawing	A-100866LE-756	Connection Diagram	A-102005-52-LE

100866LE

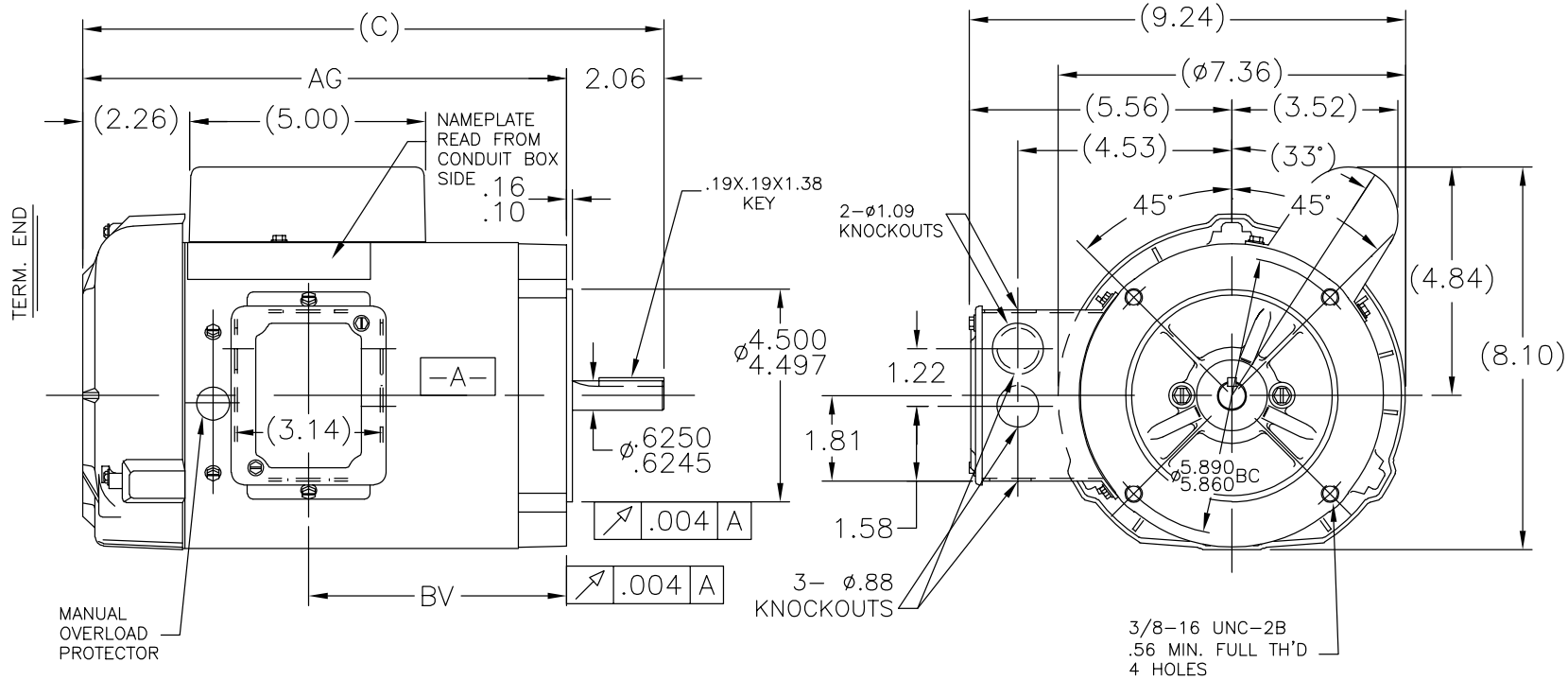

DASH	FR.	C	AG	BV	DASH	FR.	C	AG	BV
					806	56-80	13.32	11.25	6.47
656	56-65	11.82	9.75	4.97	856	"-85	13.82	11.75	6.97
706	"-70	12.32	10.25	5.47	906	"-90	14.32	12.25	7.47
756	"-75	12.82	10.75	5.97	956	"-95	14.82	12.75	7.97

NOTES:

1. CONDUIT BOX CAN BE ROTATED 180°
2. DRAIN HOLE AT 12 O'CLOCK IN C-FACE TO BE PLUGGED.
3. DRAIN HOLES AT 6 O'CLOCK BOTH ENDS ARE NOT TO BE PLUGGED.

ORACLE REV 001

		TOLERANCES UNLESS SPECIFIED		LEESON ELECTRIC MOTORS GEARMOTORS AND DRIVES		DRAWN LZ 03-19-1994	
		DEC.	INCHES			CHK ML 03-22-1994	
		.X	±.1			APPD MS 03-22-1994	
		.XX	±.03	TITLE OUTLINE		SCALE 5=16	
		.XXX	±.005	56 FR - BB - TEFC - C FACE 1φ		REF	
		.XXXX	±.0005	MAT'L.		FMF	
C	ADDED NOTES #2 & #3 ECR 0080066	CHK	ANG ±7'30"	FINISH		PREV	
NO.	REVISION	BY & DATE	RFP	CAD FILE 100866LE		SIZE A	DRAWING NO. PAGE OF REV. 100866LE C

THIS DRAWING IN DESIGN AND DETAIL IS OUR PROPERTY AND MUST NOT BE USED EXCEPT IN CONNECTION WITH OUR WORK ALL RIGHTS OF DESIGN AND INVENTION ARE RESERVED THIS IS AN ELECTRONICALLY GENERATED DOCUMENT - DO NOT SCALE THIS PRINT

LOW VOLTAGE - CCW

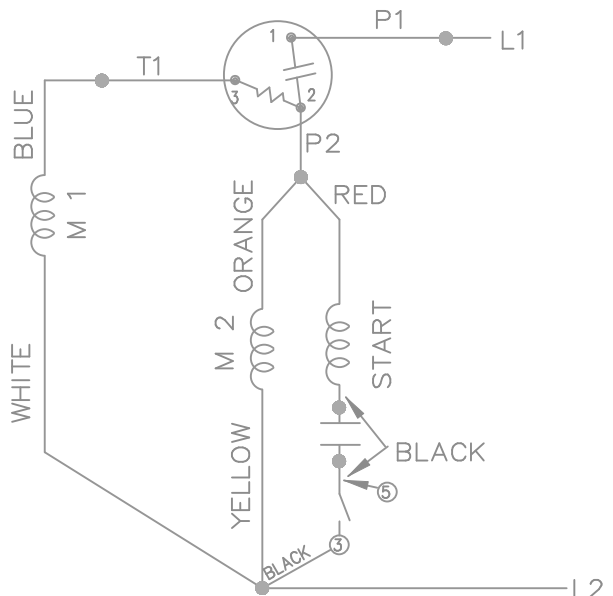

HIGH VOLTAGE - CCW

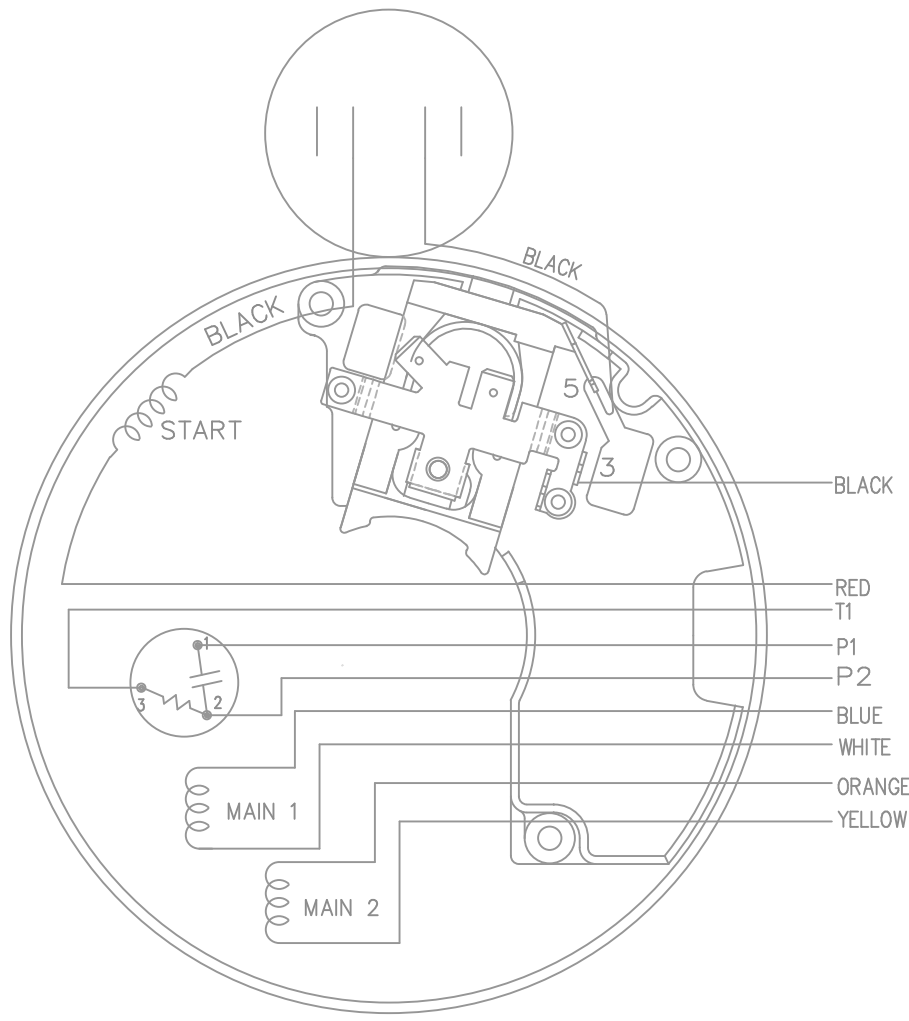
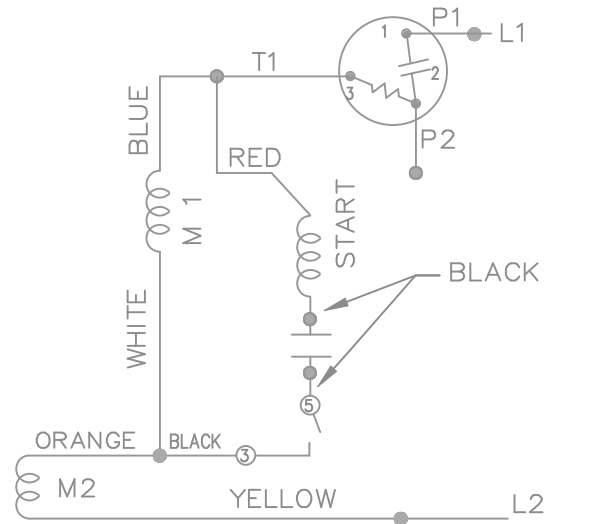

DUAL VOLTAGE
CAPACITOR START
OVERLOAD
SELECT ROTATION

LOW VOLT. CCW ROT.

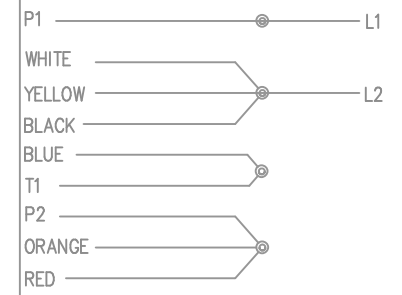

HIGH VOLT. CCW ROT.

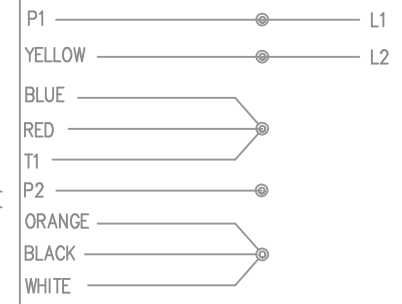

FOR CW ROTATION
EITHER VOLTAGE
INTERCHANGE RED
WITH BLACK

				TOLERANCES UNLESS SPECIFIED		 ELECTRIC MOTORS GEARMOTORS AND DRIVES		DRAWN NJS 09-03-2002				
				DEC.	INCHES			CHK ML 09-04-2002				
				.X	±.1			APPD GK 09-09-2002				
				.XX	±.02			SCALE 5=8				
				.XXX	±.005			REF				
1	NEW DRAWING	MU43222	NJS 09-09-2002	ML	.XXXX	±.0005	MAT'L.	FMF				
NO.	REVISION	BY & DATE	CHK	ANG	±7'30"		FINISH	PREV				
THIS DRAWING IN DESIGN AND DETAIL IS OUR PROPERTY AND MUST NOT BE USED EXCEPT IN CONNECTION WITH OUR WORK ALL RIGHTS OF DESIGN AND INVENTION ARE RESERVED THIS IS AN ELECTRONICALLY GENERATED DOCUMENT - DO NOT SCALE THIS PRINT				RFP	CAD FILE 102005-52-LE			SIZE	DRAWING NO.	PAGE	OF	REV.
				DIST	WP			A	102005-52-LE			1

