



Service Manual

SUBMERSIBLE PUMPS • JET PUMPS

Submersibles: (Pages 1 - 61)	Page
Safety Warnings	3-5
Typical Systems	6-7
Motor Cooling	8
Troubleshooting.....	9-11
Amprobe Instructions.....	12
Ohmmeter Instructions	13
Measuring Insulation Resistance.....	14
Coil Checkout.....	15
Relay Checkout	16-17
Contactors Checkout	18
Overload Checkout	19
Capacitor Checkout.....	20
Fuse Checkout.....	21
Voltage Checkout	22-25
Amperage Checkout.....	26-27
Wire Diagrams.....	28-33
Cable Checkout	34-35
Motor Insulation & Winding Resistance	36-39
1Ø Motor Data and Wire Sizing	40-45
3Ø Motor Data and Wire Sizing	46-51
Aquavar SOLO Wire Sizing	52-53
3Ø 6" - 10" Motor Data	54-57
Pressure Tank Checkout	60-61
Jet Pumps: (Pages 62 - 99)	
Typical Systems	62-63
Jet Pumps	64-67
Troubleshooting.....	68-73
Voltage Check	74
Amperage Checks	75-76
Ohmmeter Checks	77-86
Pressure Switch Adjustment Checkout	87
Checking Suction Lift.....	87-89
Pressure Control Valves.....	90
Rotation	91
Three Phase Unbalance	92-93
Transformer Sizes.....	94-95
Quick Start Guides.....	96-99

Safety Warnings

TO AVOID SERIOUS OR FATAL PERSONAL INJURY OR MAJOR PROPERTY DAMAGE, READ AND FOLLOW ALL SAFETY INSTRUCTIONS IN MANUAL AND ON PUMP. THIS MANUAL IS INTENDED TO ASSIST IN THE INSTALLATION AND OPERATION OF THIS UNIT AND MUST BE KEPT WITH THE PUMP.



This is a SAFETY ALERT SYMBOL. When you see this symbol on the pump or in the manual, look for one of the following signal words and be alert to the potential for personal injury or property damage.



Warns of hazards that WILL cause serious personal injury, death or major property damage.



Warns of hazards that CAN cause serious personal injury, death or major property damage.



Warns of hazards that CAN cause personal injury or property damage.

NOTICE: INDICATES SPECIAL INSTRUCTIONS WHICH ARE VERY IMPORTANT AND MUST BE FOLLOWED.

THOROUGHLY REVIEW ALL INSTRUCTIONS AND WARNINGS PRIOR TO PERFORMING ANY WORK ON THIS PUMP.

MAINTAIN ALL SAFETY DECALS.

Important notice: Read safety instructions before proceeding with any wiring.



All electrical work must be performed by a qualified technician. Always follow the National Electrical Code (NEC), or the Canadian Electrical Code, as well as all local, state and provincial codes. Code questions should be directed to your local electrical inspector. Failure to follow electrical codes and OSHA safety standards may result in personal injury or equipment damage. Failure to follow manufacturer's installation instructions may result in electrical shock, fire hazard, personal injury or death, damaged equipment, provide unsatisfactory performance, and may void manufacturer's warranty.



Standard units are not designed for use in swimming pools, open bodies of water, hazardous liquids, or where flammable gases exist. Well must be vented per local codes. See specific pump catalog bulletins or pump nameplate for all agency Listings.



Disconnect and lockout electrical power before installing or servicing any electrical equipment. Many pumps are equipped with automatic thermal overload protection which may allow an overheated pump to restart unexpectedly.



Never over pressurize the tank, piping or system to a pressure higher than the tank's maximum pressure rating. This will damage the tank, voids the warranty and may create a serious hazard.



Protect tanks from excessive moisture and spray as it will cause the tank to rust and may create a hazard. See tank warning labels and IOM for more information.



Do not lift, carry or hang pump by the electrical cables. Damage to the electrical cables can cause shock, burns or death.



Use only stranded copper wire to pump/motor and ground. The ground wire must be at least as large as the power supply wires. Wires should be color coded for ease of maintenance and troubleshooting.



Install wire and ground according to the National Electrical Code (NEC), or the Canadian Electrical Code, as well as all local, state and provincial codes.



Install an all leg disconnect switch where required by code.



The electrical supply voltage and phase must match all equipment requirements. Incorrect voltage or phase can cause fire, motor and control damage, and voids the warranty.



All splices must be waterproof. If using splice kits follow manufacturer's instructions.



Select the correct type and NEMA grade junction box for the application and location. The junction box must insure dry, safe wiring connections.



All motors require a minimum 5' submergence for proper refill check valve operation.



Failure to permanently ground the pump, motor and controls before connecting to power can cause shock, burns or death.



All three phase (3Ø) controls for submersible pumps must provide Class 10, quick-trip, overload protection.



4" motors \geq 2 HP require a minimum flow rate of .25 ft/sec. or 7.62 cm/sec. past the motor for proper motor cooling. The following are the minimum flows in GPM per well diameter required for cooling: 1.2 GPM/4", 7 GPM/5", 13 GPM/6", 20 GPM/7", 30 GPM/8" or 50 GPM in a 10" well.



Pumps \geq 2 HP installed in large tanks should be installed in a flow inducer sleeve to create the needed cooling flow or velocity past the motor.

Two-Wire System Illustrated



RULE OF THUMB

1. Use same size or larger pipe as discharge on pump.
2. Always use a check valve for every 200 ft. of vertical pipe.

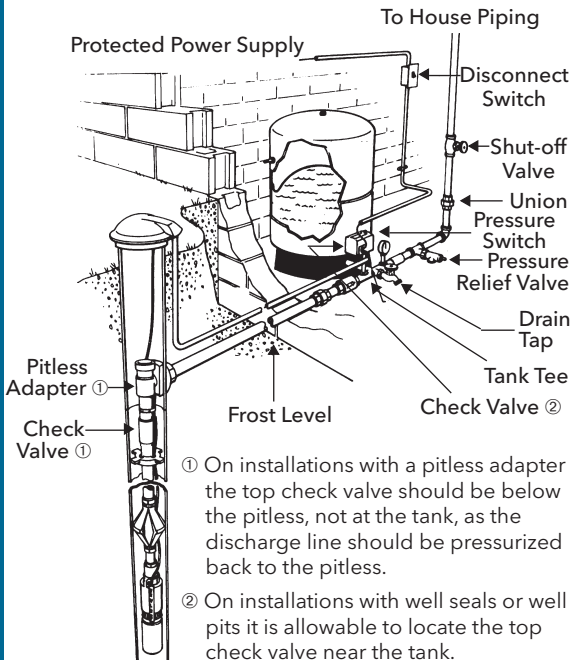

CAUTION

All electrical equipment must be connected to supply ground. Follow applicable code requirements.

Motor Cooling, Temperature and Time Ratings

All 4 inch CentriPro motors may be operated continuously in water up to 86° F. Optimum service life will be attained by maintaining a minimum flow rate past the motor of .25 feet per second. Use a Flow Sleeve if velocity is below the .25'/sec, if the well is top feeding or when the pump is used in a large body of water or large tank.

Six (6) inch canned design motors from 5 - 40 HP will operate in water up to 95° F (35° C), without any de-rating of horsepower, with a minimum flow rate of .5 ft./sec. past the motor. 6" - 50 HP and all 8" - 10" motors can operate in 77° F (25° C) water with .5'/sec velocity past the motor.

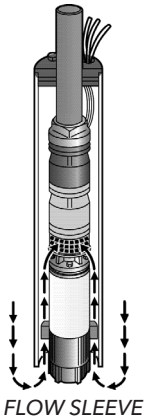

One way to make a flow sleeve is to install a well seal above the pump discharge and slip a piece of casing over the pump and affix it to the well seal. Drill three holes at 120° intervals on the lower section of the casing and insert (3) screws and nuts through the casing, just touching the motor. Tighten the nuts out against the casing. Insure that the screws do not protrude out too far as you don't want them catching on well joints.

Pump Cooling and Lubrication

In addition to motor cooling, another reason to maintain minimum flow rates is pump lubrication. All manufacturers', either on curves or in selection charts, show minimum flows. This insures that rotating pump parts are properly lubricated to prolong service life and reduce friction. A dead headed pump will super heat water very quickly, and hot water has no lubricity.

Minimum Flow Rates for Proper Motor Cooling

Well or Sleeve Diameter (inches)	3.75" Dia. 4" CP or FE Motor .25'/sec	CP = 5.5" Dia. 6" CP Motor .5'/sec.	FE = 5.38" Dia. 6" FE Motor .5'/sec.	CP = 7.52" Dia. 8" CP Motor .5'/sec.
	GPM Required			
4	1.2	-	-	-
5	7	-	-	-
6	13	7	9	-
7	20	23	25	-
8	30	41	45	9
10	50	85	90	53
12	80	139	140	107
14	110	198	200	170
16	150	276	280	313

Multiply gpm by .2271 for m³/Hr.

Multiply gpm by 3.785 for l/min.



IMPORTANT

This manual is intended ONLY for use by professionals familiar with NEC (National Electric Codes) electrical codes and hydraulic and safety procedures of pump installations.

Pump Motor Not Running

Probable Cause

1. Motor thermal protector tripped
 - a. Incorrect control box
 - b. Incorrect or faulty electrical connections
 - c. Faulty thermal protector
 - d. Low voltage
 - e. Ambient temperature of control box/starter too high
 - f. Pump bound by foreign matter
 - g. Inadequate submergence

Recommended Action

1. Allow motor to cool, thermal protector will automatically reset
 - a - e. Have a qualified electrician inspect and repair, as required
 - f. Pull pump, clean, adjust set depth as required
 - g. Confirm adequate unit submergence in pumpage

2. Open circuit breaker or blown fuse

2. Have a qualified electrician inspect and repair, as required

3. Power source inadequate for load

3. Check supply or generator capacity

4. Power cable insulation damage

- 4 - 5. Have a qualified electrician inspect and repair, as required

5. Faulty power cable splice



RULE OF THUMB

Remember, there may be other system problems caused by auxiliary controls not covered in this booklet.

Little or No Liquid Delivered by Pump

Probable Cause	Recommended Action
1. Faulty or incorrectly installed check valve	1. Inspect check valve, repair as required
2. Pump air bound	2. Successively start and stop pump until flow is delivered
3. Lift too high for pump	3. Review unit performance, check with dealer
4. Pump bound by foreign matter	4. Pull pump, clean, adjust set depth as required
5. Pump not fully submerged	5. Check well recovery, lower pump if possible
6. Well contains excessive amounts of air or gases	6. If successive starts and stops does not remedy, well contains excessive air or gases
7. Excessive pump wear	7. Pull pump and repair as required
8. Incorrect motor rotation - 3Ø only.	8. Reverse any two motor electrical leads

Pump Will Not Start or Run. . .

Probable Cause	Recommended Action
1. No power	1. Check for tripped circuit breaker
2. Incorrect voltage	2. Check with voltmeter
3. Defective pressure switch	3. Inspect switch points and wires
4. Loose wire connections	4. Check all connections and splices
5. Cable insulation damaged	5. Perform cable check with ohmmeter
6. Damaged or poor splice	6. Perform cable check with ohmmeter
7. Pump bound by sand or abrasives	7. Pull pump and repair as required

Pump Starts Too Frequently. . .

Probable Cause	Recommended Action
1. Waterlogged tank	1. Check tank pressure when empty of water
2. Check valve broken or stuck open	2. Replace check valve
3. Improper switch setting	3. Adjust switch
4. Improper switch placement	4. Move switch closer to tank
5. Leaks in piping	5. Replace defective pipe
6. Tank too small for pump	6. Install larger tank



The Amprobe is a multi-range, combination ammeter and voltmeter.

Voltmeter Scales:	150 Volts	600 Volts
Ammeter Scales:	5 Amps	40 Amps
	15 Amps	100 Amps

1. When used as an ammeter, the tongs are placed around the wire being measured with the rotary scale on the **100 amp range**. Then rotate the scale back to the smaller ranges until an exact reading is indicated.
2. When used as a voltmeter, the two leads are clipped into the bottom of the instrument with the rotary scale on the 600 volt range. If the reading is less than 150 volts, rotate the scale to the 150 volt range to get a more exact reading.

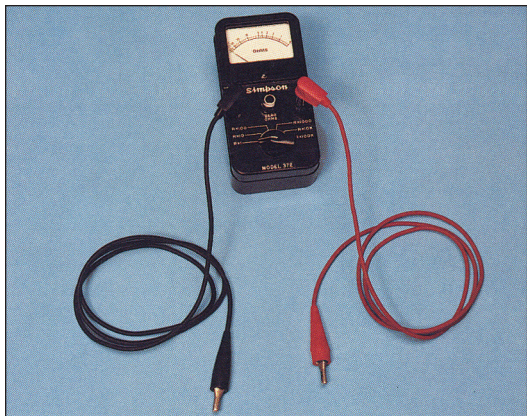

The Ohmmeter is used for measuring the electrical resistance of a wire circuit. The unit of measurement is called an Ohm.

1. The knob at the bottom of the Ohmmeter is adjustable through six ranges:

RX₁	= R x 1
RX₁₀	= R x 10
RX₁₀₀	= R x 100
RX₁₀₀₀	= R x 1,000
RX_{10K}	= R x 10,000
RX_{100K}	= R x 100,000

If your ohmmeter is digital readout type, refer to the instructions that came with it.

2. The round center knob is for the purpose of adjusting the instrument to zero (0) after clipping the two ohmmeter leads together. This must be done every time the range selection is changed.



CAUTION

Use Ohmmeter only with power off.

Megger



This instrument is used to measure insulation resistance to ground. It consists of a crank-turned magneto, on the side of the case, and will give very close readings calibrated directly in ohms. It is cranked at a moderate rate of speed, approximately 120 rpm, until the pointer reaches a steady deflection.

- 1.** If the ohm value is normal, the motor windings are not grounded and the cable insulation is not damaged.
- 2.** If the ohm value is below normal, either the windings are grounded or the cable insulation is damaged. Check the cable at the well seal as the insulation is sometimes damaged by being pinched.

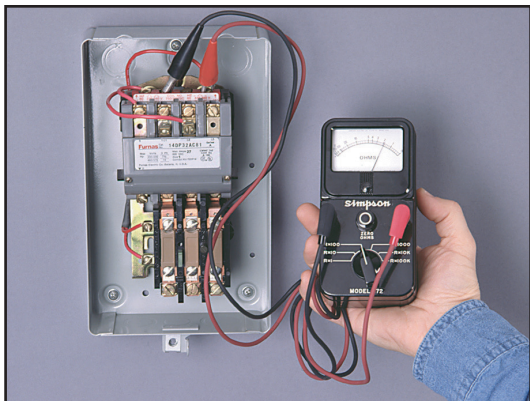

WARNING!

Open master breaker and disconnect all leads from starter to avoid damage to meter or electric shock hazard. Connect the ohmmeter leads as shown above.

Coil with Ohmmeter

1. Set R x 1000.
2. Connect leads as shown.
3. Reading: Should register some value, Approx. 200-1000 ohms.

What It Means -

Infinity reading indicates coil is open. Zero reading indicates coil is shorted. In either case, the coil should be replaced.

A reading of 200-1000 ohms indicates coil is ok.

Voltage Relay

CONTROL BOXES (CENTRIPRO OR F.E.)

Checking Relay with Ohmmeter

A. Voltage Relay Tests

Step 1, Coil Test

1. Meter setting: R x 1,000.
2. Connections: #2 & #5.
3. Correct meter readings:

For 115 Volt Boxes:

.7 - 1.8 (700 to 1,800 ohms).

For 230 Volt Boxes

4.5 - 7.0 (4,500 to 7,000 ohms).

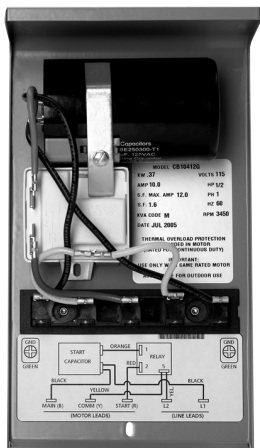

Voltage Relay

CONTROL BOXES (CENTRIPRO OR F.E.)

Step 2, Contact Test

1. Meter setting: R x 1.
2. Connections: #1 and #2.
3. Correct meter reading:
Zero for all models.

B. Blue Relay - Solid State

1/3 - 1 HP QD Control Boxes

Used from 1994 until present time:

Step 1, Triac Test

1. Meter setting: R x 1,000.
2. Connections: Cap and B terminal.
3. Correct meter reading: *Infinity for all models.*

Step 2, Coil Test

1. Meter setting: R x 1.
2. Connections: L1 and B.
3. Correct meter reading:
Zero ohms for all models.

Checkout Procedure for Magnetic and Other Contactors

Contactor Coil Test

(Disconnect lead from one side of coil)

1. Meter setting: R X 100
2. Connections: Coil terminals
3. Correct meter reading: 180 to 1,400 ohms

Contactor Contact Test

1. Meter Setting: R X 1
2. Connections: L1 & T1 or L2 & T2
3. Manually close contacts
4. Correct meter reading: Zero ohms

Additional information on troubleshooting and replacement parts for 1Ø Control Boxes is available in the MAID; Motor Application and Installation Manual. It is also available online at www.gouldswatertechnology.com.

For 1½ HP (and Larger) Control Box

1. Set Ohmmeter at "R x 1"
2. Connect the Ohmmeter leads to Terminal #1 and #3 on each Overload Protector.
3. Reading should be not more than 0.5 Ohms maximum on the scale.

CSCR or Mag. Contactor Control Box

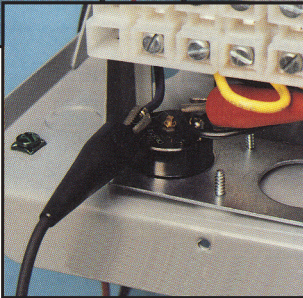
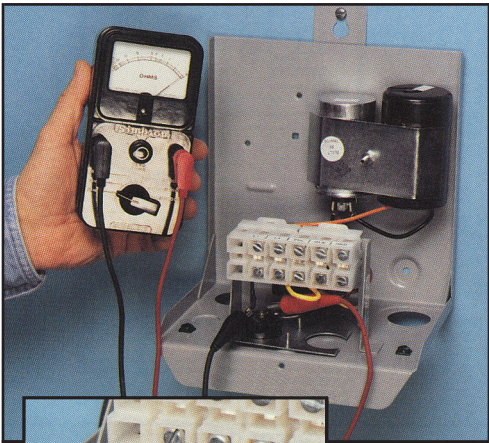

Capacitor with Ohmmeter

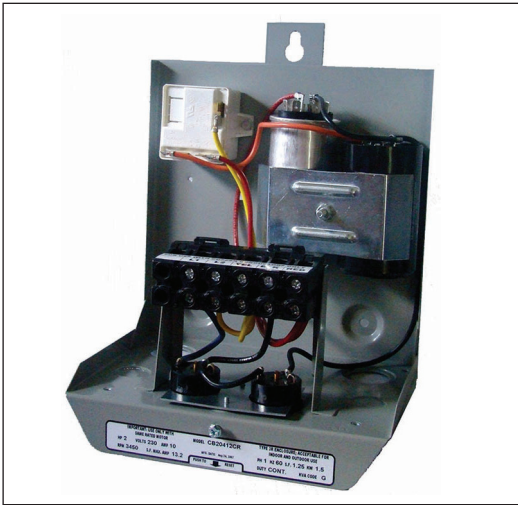

CAUTION

Discharge the capacitor before making this check. (A screwdriver can be used to make contact between capacitor's posts.)

1. Disconnect leads to capacitor post.
2. Setting: R x 1,000
3. Connect ohmmeter leads to capacitor posts.
4. Reading: Pointer should swing toward zero, then back toward infinity.

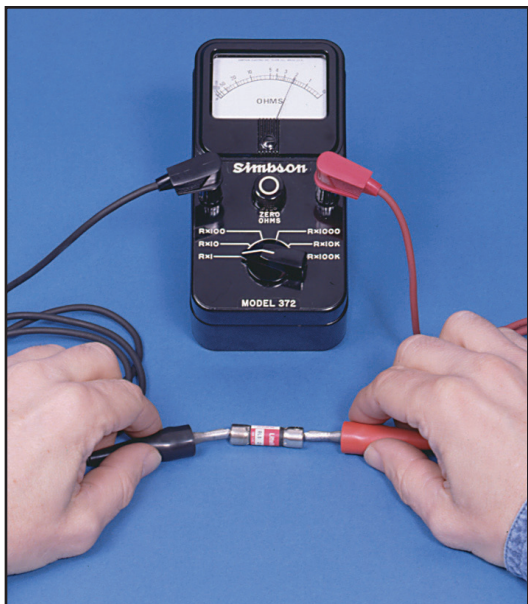

1. Set R x 1.
2. Connect leads as shown.
3. Reading: Should register zero.

What It Means -

Zero reading indicates fuse OK. Infinity (∞) reading indicates bad fuse.

To Check Voltage with "Q.D." Type Control Box

1. Remove cover to break all motor connections.



CAUTION

L_1 and L_2 are still connected to power.

2. To check VOLTAGE: Use voltmeter on L1 and L2 as shown.
3. When checking voltage, all other major electrical appliances (that could be in use at the same time) should be running.
4. If readings are not within the limits (see chart), call your power supplier.

Voltage Limits		
Nameplate ▼	Measured Volts	
	Min.	Max.
115V 1Ø	105	125
208V 1Ø	188	228
230V 1Ø	210	250

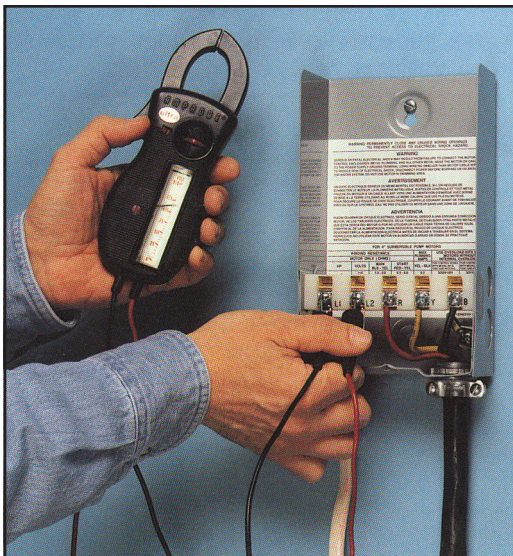

Checking Voltage at Fused Disconnect and Magnetic Starter



WARNING!

Power is ON during voltage checking.

- To check voltage: Use voltmeter on L1, L2 and L3 in sequence. Check should be made at four locations.
 - Step 1** Checking incoming power supply.
 - Step 2** Checking fuses.
 - Step 3** Checking contact points
 - Step 4** Checking heaters.
 - When checking voltage, all other major electrical appliances (that could be in use at the same time) should be running.
 - If incoming power supply readings are not within the limits (see chart), call your power supplier.
- NOTE:** Phase to phase - full line voltage.

Voltage Limits		
Name Plate ▼	Measured Volts	
	Minimum	Maximum
208V 3Ø	188	228
230V 3Ø	207	253
460V 3Ø	414	506
575V 3Ø	518	632

Phase to neutral - ½ full line voltage.
(depending on transformer connection)

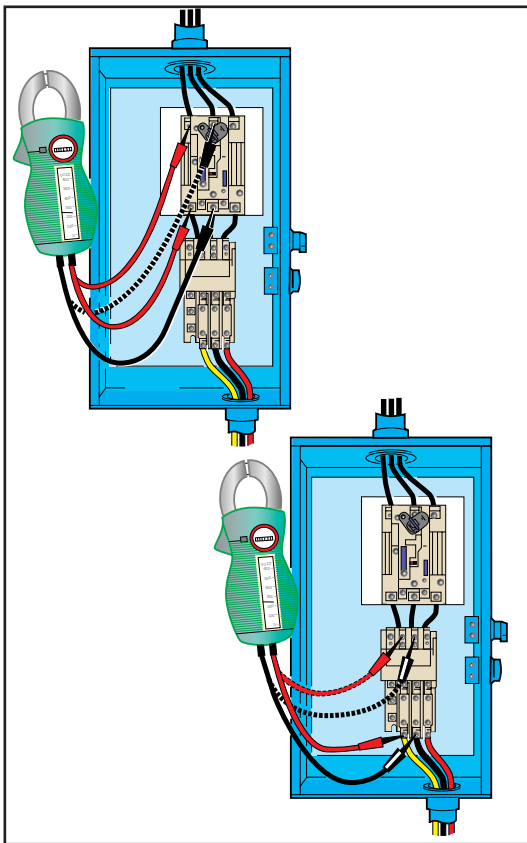



WARNING!

Power is ON during current checking.

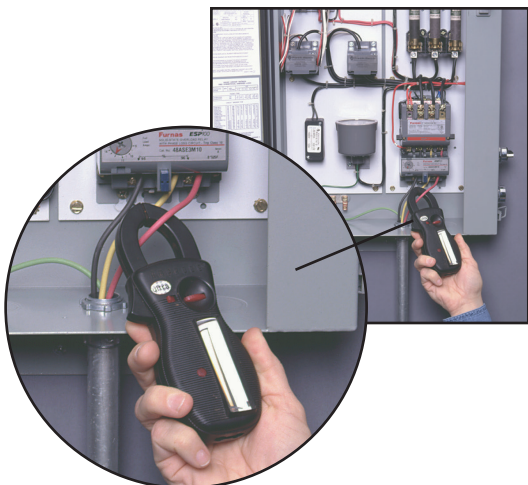

Using Amprobe

1. Set scale to highest amp range.
2. Connect amprobe around lead as shown.
3. Rotate scale to proper range and read value.
4. Compare value with table.

What It Means -

Currents above these values indicate system problems.

**Service Factor Amps with QD (½ - 1 HP) or
CSCR (1.5 HP & Larger) Control Boxes ①**

4" 1Ø		CP 3-Wire			F.E. 3-Wire			CP 2-Wire	F.E. 2-Wire
HP	Volts	Yel	Black	Red	Yel	Black	Red	Black	Black
½	115	12.6	12.6	0	12.0	12.0	0	9.5	12.0
½	230	6.3	6.3	0	6.0	6.0	0	4.7	6.0
¾		8.3	8.3	0	8.0	8.0	0	6.4	8.0
1		9.7	9.7	0	9.8	9.8	0	9.1	9.8
1½		11.1	11.0	1.3	11.5	11.0	1.3	11.0	13.1
2		12.2	11.7	2.6	13.2	11.9	2.6	N/A	
3		16.5	13.9	5.6	17.0	12.6	6.0		
5	27.0	22.0	10.0	27.5	19.1	10.8			

① Generation I CentriPro data. See pages 37-41 for Generation II data.

**Service Factor Amps with Magnetic Contactor
Control Boxes**

6" 1Ø		CentriPro 3-Wire			Franklin Electric 3-Wire		
HP	Volts	Yel	Black	Red	Yel	Black	Red
5	230	27.5	N/A	N/A	27.5	17.4	10.5
7.5		41.0	N/A	N/A	42.1	40.5	5.4
10		58.0	N/A	N/A	51.0	47.5	8.9
15		85.0	N/A	N/A	75.0	62.5	16.9

Magnetic Starter and Pressure Switch

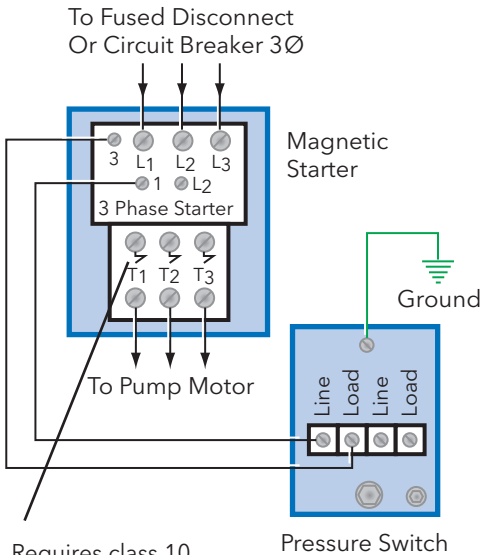

Requires class 10 quick trip "k-heaters" (overloads), or adjustable class 10 overloads such as ESP100, ESP 200

NOTE:

Check to be sure proper selection of pressure switch matched to system voltage has been made... refer to catalog data.

Check that starter has ground.

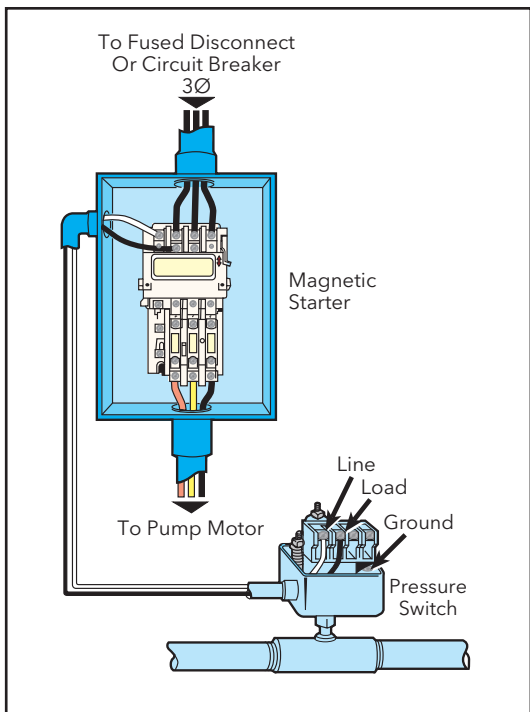

RULE OF THUMB

Check that starter has ground.

Magnetic Starter, Pressure Switch and Liquid Level Control

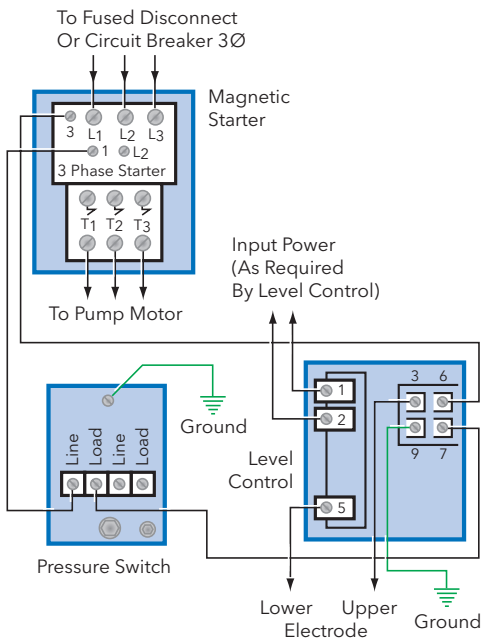

NOTE:

Check to be sure proper selection of pressure switch matched to system voltage has been made... refer to catalog data.

Check that starter has ground.

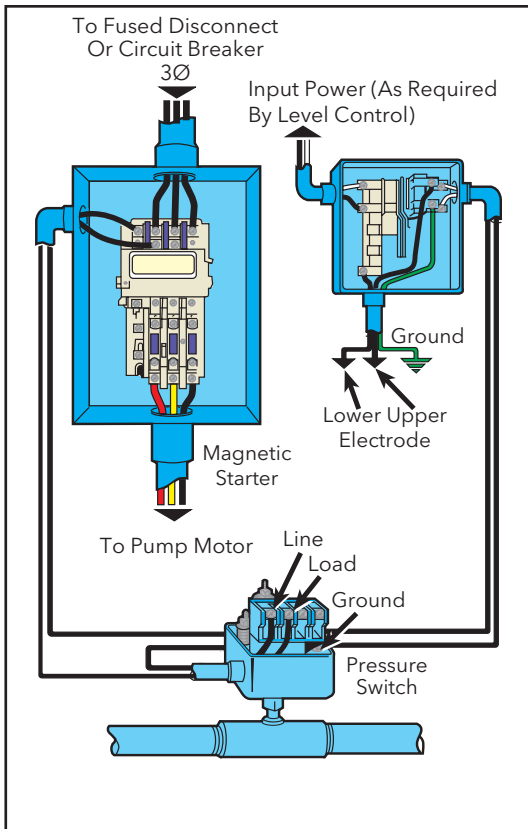

2-Wire Pump Wiring Diagram with PumpSaver Plus 233P

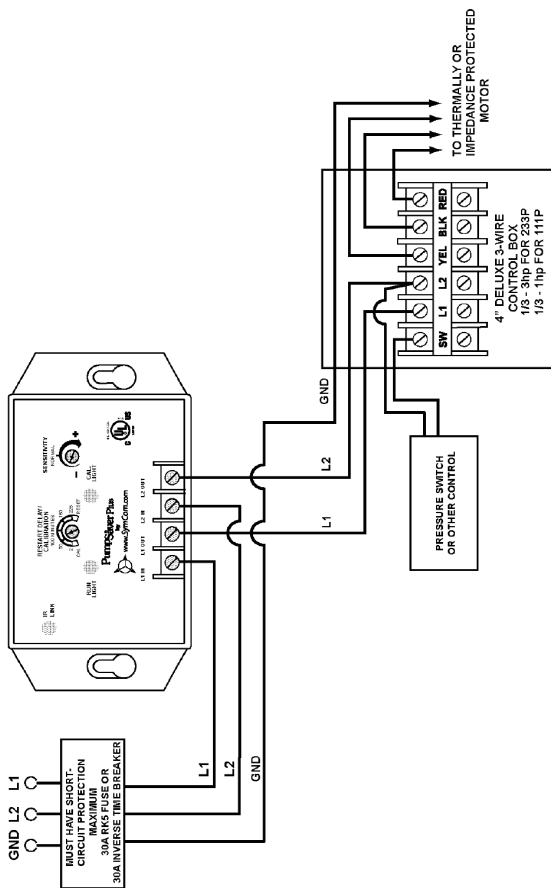

Checking Cable and Splice

- 1.** Submerge cable and splice in steel barrel of water with both ends out of water.
- 2.** Set ohmmeter selector on RX100K and adjust needle to zero (0) by clipping ohmmeter leads together.
- 3.** After adjusting ohmmeter, clip one ohmmeter lead to barrel and the other to each cable lead individually, as shown.
- 4.** If the needle deflects to zero (0) on any of the cable leads, pull the splice up out of the water. If the needle falls back to (∞) (no reading) the leak is in the splice.
- 5.** If leak is not in the splice, pull the cable out of the water slowly until needle falls back to (∞) (no reading). When the needle falls back, the leak is at that point.
- 6.** If the cable or splice is bad, it should be repaired or replaced.

Checking Cable and Splice Test

Ohmmeter
Set at RX 100K

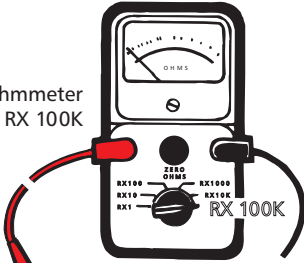

Attach this Lead
to Metal Tank

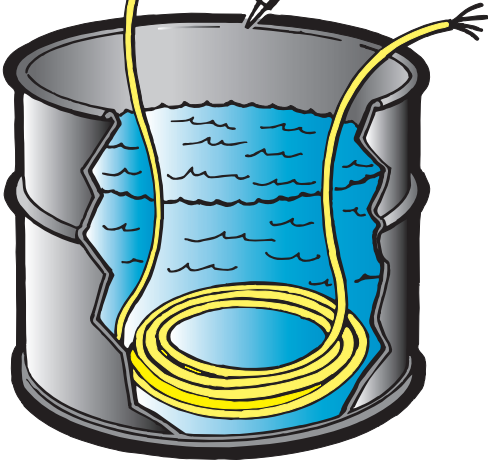

1. Set the scale lever to R x 100K and adjust to 0.

**CAUTION**

Open (turn off) master breaker and disconnect all leads from control box or pressure switch (Q-D type control, remove lid) to avoid damage to meter or electric shock hazard.

2. Connect an ohmmeter lead to any one of the motor leads and the other to the metal drop pipe. If the drop pipe is plastic, connect the ohmmeter lead to the metal well casing or ground wire.

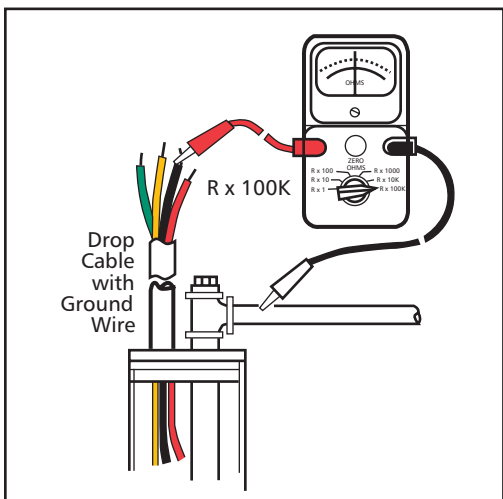

Normal Ohm and Megohm Values (Insulation Resistance) Between All Leads and Ground

Insulation resistance does not vary with rating. All motors of all HP, voltage and phase rating have similar values of insulation resistance.

Condition of Motor and Leads	Ohms Value	Megohm Value
A new motor (without drop cable).	20,000,000 (or more)	20.0
A used motor which can be reinstalled in the well.	10,000,000 (or more)	10.0
New motor in the well	2,000,000 (or more)	2.0 (or more)
Motor in the well in good condition	500,000 - 2,000,000	0.5 - 2.0
Insulation damage, locate and repair	Less than 500,000	Less than .50

What it Means

1. If the ohm value is normal, the motor windings are not grounded and the cable insulation is not damaged.
2. If the ohm value is below normal, either the windings are grounded or the cable insulation is damaged. Check the cable at the well seal as the insulation is sometimes damaged by being pinched.

1. Set the scale lever to R x 1 for values under 10 ohms. For values over 10 ohms, set the scale lever to R x 10. Zero balance the ohmmeter as described earlier.

! WARNING!

Open master breaker and disconnect all leads from starter to avoid damage to meter or electric shock hazard. Connect the ohmmeter leads as shown below.

2. Connect the ohmmeter leads as shown below.

Cable Resistance - Copper

Size Cable	Paired Wire
	Resistance (ohms per foot)
14	.0050
12	.0032
10	.0020
8	.0013
6	.0008
4	.0005
2	.0003
0	.0002
00	.00015
000	.00013
0000	.00010

If aluminum cable is used the readings will be higher. Divide the ohm readings on this chart by 0.61 to determine the actual resistance of aluminum cable.

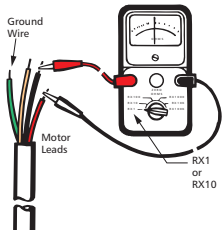

See motor data pages for motor resistance ratings.

What it Means

1. If all ohm values are normal, the motor windings are neither shorted nor open, and the cable colors are correct.
2. If any one ohm value is less than normal, the motor is shorted.
3. If any one ohm value is greater than normal, the winding or the cable is open or there is a poor cable joint or connection.
4. If some ohm values are greater than normal and some less, the leads are mixed.

Motor Resistance

3-Wire CentriPro Motors Winding Resistance ¹

HP	Volts	Generation II (2011) ¹		Generation II (2015)	
		Winding Resistance		Winding Resistance	
		Main (B-Y)	Start (R-Y)	Main (B-Y)	Start (R-Y)
0.5	115	1.0 - 1.4	2.5 - 3.1	1.0 - 1.4	2.5 - 3.1
0.5	230	5.1 - 6.1	12.4 - 13.7	5.1 - 6.1	12.4 - 13.7
0.75	230	2.6 - 3.3	10.4 - 11.7	2.6 - 3.3	10.4 - 11.7
1.0	230	2.0 - 2.6	9.3 - 10.4	2.0 - 2.6	9.3 - 10.4
1.5	230	2.1 - 2.5	10.0 - 10.8	2.1 - 2.5	10.0 - 10.8
2	230	1.6 - 2.2	10.8 - 12.0	1.6 - 2.2	4.8 - 5.9
3	230	1.1 - 1.4	2.0 - 2.5	1.0 - 1.4	2.0 - 2.5
5	230	.62 - .76	1.36 - 1.66	0.6 - 0.8	1.3 - 1.7

¹ As part of Faradyne Motors' continual improvement process, two waves of improvements have been made to CentriPro motors. Generation I motors are any motor with a date code prior to April 2011. Information on Generation I motors can be found in the Motor and Installation Manual on Goulds.com. Generation II (2011) motor are motors with dates codes between April 2011 and November 2015. Generation II (2015) motors are motors with dates codes after November 2015. CentriPro motor date codes are 12 characters long, the first character represents the month and the fourth and fifth character represent the year. For example, a date code beginning with "L__ 15..." would be a Generation II (2015) motor.



RULE OF THUMB

Add resistance of drop cable when checking pump in well. See Cable Resistance.

2-Wire PSC, 1Ø, 4" Motors - Electrical Data, 60 Hz, 3450 RPM

GENERATION II 2011 - 2-Wire CentriPro Motors
Resistance, Amps and KVA Code

HP	Volts	FLA	SF Amps	LRA	Resistance	KVA
0.5	115	7.9	9.8	28	1.4 - 2.0	H
0.5	230	4	4.7	16	6.1 - 7.2	J
0.75	230	5	6.2	18	5.9 - 6.9	F
1.0	230	6.7	8.1	24	4.2 - 5.2	F
1.5	230	9	10.4	44	1.8 - 2.4	H

GENERATION II 2015 - 2-Wire CentriPro Motors
Resistance, Amps and KVA Code

HP	Volts	FLA	SF Amps	LRA	Resistance	KVA
0.5	115	8.1	10.2	28	1.4 - 2.0	H
0.5	230	4.3	4.8	16	6.1 - 7.2	J
0.75	230	5	6.4	18	5.9 - 6.9	F
1.0	230	6.7	8.2	24	4.2 - 5.2	F
1.5	230	9.1	11	43	1.8 - 2.4	H

Motor Resistance

1Ø Motors - Winding Resistance Motor Only (Ohms)

6" Motors			CentriPro				Franklin Electric		
Type	HP	Volts	Resistance			KVA	Resistance		KVA
			R - Y	B - Y	R - B	Code	(B-Y)	(R-Y)	Code
6" 1Ø	5	230	2.17	0.51	2.63	G	.55-.68	1.3-1.7	E
	7.5		1.40	0.4	1.77	F	.36-.50	.88-1.1	F
	10		1.05	0.316	1.31	E	.27-.33	.80-.99	E
	15		0.68	0.23	0.85	D	.17-.22	.68-.93	E

2-Wire and 3-Wire - Fuse and Circuit Breaker Amps

GENERATION I & II - 2011

Type	Order No. CentriPro	HP	Fuse or Circuit Breaker Amps		
			Standard Fuse	Dual Element Time Delay	Circuit Breaker
2-Wire (PSC)	M05421	0.5	25	15	20
	M05422	0.5	15	10	10
	M07422	0.75	20	10	15
	M10422	1.0	25	15	20
	M15422	1.5	30	15	25
3-Wire QD (CSIR)	M05411	0.5	30	20	30
	M05412	0.5	15	10	15
	M07412	0.75	20	10	20
	M10412	1.0	25	15	25
3-Wire CSCR	M05412	0.5	15	10	10
	M07412	0.75	20	10	15
	M10412	1.0	20	10	15
	M15412	1.5	30	15	25
	M20412	2.0	30	20	25
	M30412	3.0	45	25	40
M50412	5.0	70	40	60	

GENERATION II - 2015

Type	Order No. CentriPro	HP	Fuse or Circuit Breaker Amps		
			Standard Fuse	Dual Element Time Delay	Circuit Breaker
2-Wire (PSC)	M05421	0.5	25	15	20
	M05422	0.5	15	10	10
	M07422	0.75	15	10	15
	M10422	1.0	20	15	20
	M15422	1.5	30	20	25
3-Wire QD (CSIR)	M05411	0.5	30	20	30
	M05412	0.5	20	10	15
	M07412	0.75	20	15	20
	M10412	1.0	25	15	25
3-Wire CSCR	M05412	0.5	15	10	10
	M07412	0.75	15	10	15
	M10412	1.0	20	15	15
	M15412	1.5	30	20	25
	M20412	2.0	30	20	25
	M30412	3.0	45	25	40
M50412	5.0	80	45	60	

3-Wire, 1Ø, 4" Motors - Electrical Data, 60 Hz, 3450 RPM

Order No.		HP	Volts	SF
Type	CentriPro			
3-Wire with Q.D. Cap. Start Box	M05411	0.5	115	1.6
	M05412	0.5	230	1.6
	M07412	0.75		1.5
	M10412	1.0		1.4
3-Wire with CSCR (CR) or Magnetic Contactor (MC) Control Box	M05412	0.5		1.6
	M07412	0.75		1.5
	M10412	1.0		1.4
	M15412	1.5		1.3
	M20412	2.0		1.25
	M30412	3.0		1.15
M50412	5.0	1.15		

Generation II (2011)			Generation II (2015)		
FL Amps (Y/B/R)	SF Amps (Y/B/R)	LRA	FL Amps (Y/B/R)	SF Amps (Y/B/R)	LRA
8.8/8.8/0	10.9/10.9/0	44	9.8/9.8/0	11.6/11.6/0	44
5.3/5.3/0	6.1/6.1/0	21	5.7/5.7/0	6.3/6.3/0	21
6.6/6.6/0	7.8/7.8/0	32	6.7/6.7/0	7.9/7.9/0	32
8.1/8.1/0	9.4/9.4/0	41	8.5/8.5/0	9.5/9.5/0	41
4.2/4.1/1.8	4.8/4.3/1.8	44	4.4/4.3/1.9	5.0/4.5/1.9	21
4.8/4.4/2.5	6.0/4.9/2.3	21	4.6/4.6/2.6	6.1/5.1/2.6	32
6.1/5.2/2.7	7.3/5.8/2.6	32	6.2/6.0/3.6	7.4/6.3/3.3	41
9.1/8.2/1.2	10.9/9.4/1.1	41	9.2/8.7/1.2	11.0/9.9/1.2	49
9.9/9.1/2.6	12.2/11.7/ 2.6	49	9.9/9.1/2.6	12.2/11.7/ 2.6	49
14.3/12.0/ 5.7	16.5/13.9/ 5.6	76	14.3/12.0/ 5.7	16.5/13.9/ 5.6	76
24/19.1/ 10.2	27/22/10	101	24/19.1/ 10.2	27.0/22.0/ 10.0	101

2-Wire 1Ø Motor Wire Sizing Chart

Centripro Motor Lead Lengths - 2-Wire Motors, 1Ø, 4" Motors
60° C & 75° C Insulation - AWG Copper Wire Size

Motor Lead Lengths - 2-Wire Motors							
Motor Rating					AWG Copper Wire Size		
HP	Volts	kW	FLA	SFA	14	12	10
1/2	115	0.37	8.1	10.2	107	171	273
1/2	230	0.37	4.3	4.8	457	726	1158
3/4	230	0.55	5.0	6.4	342	545	869
1	230	0.75	6.7	8.2	241	383	611
1 1/2	230	1.1	9.1	10.5	199	317	505

3-Wire 1Ø Motor Wire Sizing Chart

Centripro Motor Lead Lengths - 3-Wire Motors, 1Ø, 4" Motors
60° C & 75° C Insulation - AWG Copper Wire Size

Motor Lead Lengths - 3-Wire Motors							
Motor Rating					AWG Copper Wire Size		
HP	Volts	kW	FLA	SFA	14	12	10
CSIR Control Boxes							
1/2	115	0.37	9.8	11.6	87	138	221
1/2	230	0.37	5.7	6.3	348	553	883
3/4	230	0.55	6.7	7.9	264	420	670
1	230	0.75	8.5	9.5	226	359	573
CSCR Control Boxes							
1/2	230	0.37	4.4	5.0	348	553	883
3/4	230	0.55	4.6	6.1	264	420	670
1	230	0.75	6.2	7.4	226	359	573
1 1/2	230	1.1	9.2	11.0	197	314	501
2	230	1.5	9.9	12.2	180	286	456
3	230	2.2	14.3	16.5	133	211	337
5	230	3.7	24.0	27.0			206

Based on S.F. Amps, 30° C Ambient and 5% Voltage Drop

8	6	4	2	1/0	2/0	3/0	4/0
432	672	1071	1700	2703	3411	4305	5424
1835	2855	4551	7225	11489			
1376	2141	3413	5419	8617	10871		
968	1506	2400	3811	6060	7646	9652	
801	1246	1986	3153	5013	6325	7985	

Based on S.F. Amps, 30° C Ambient and 5% Voltage Drop

8	6	4	2	1/0	2/0	3/0	4/0
CSIR Control Boxes							
349	544	867	1376	2188	2716	3485	4391
1398	2175	3467	5505	8753			
1061	1651	2632	4178	6644	8383		
908	1413	2252	3575	5685	7173		
CSCR Control Boxes							
1398	2175	3467	5505	8753			
1061	1651	2632	4178	6644	8383		
908	1413	2252	3575	5685	7173		
793	1246	1986	3124	4968	6268		
722	1123	1790	2843	4520	5703		
534	830	1324	2102	3342	4217	5323	
326	507	809	1284	2042	2577	3253	

CentriPro Motor Electrical Data

60 Hz, 3450 RPM GENERATION I & II - 2011

Motor No.	HP	Volts	SF	FLA Amps	SFA Amps	Locked Rotor Amps	Line - Line Resistance
M05430	0.5	200	1.6	2.9	3.4	22	4.1 - 5.2
M07430	0.75		1.5	3.8	4.5	32	2.6-3.0
M10430	1		1.4	4.6	5.5	29	3.4-3.9
M15430	1.5		1.3	6.3	7.2	40	1.9-2.5
M20430	2		1.25	7.5	8.8	51	1.4-2.0
M30430	3		1.15	10.9	12.0	71	0.9-1.3
M50430	5		1.15	18.3	20.2	113	0.4-0.8
M75430	7.5		1.15	27.0	30.0	165	0.5-0.6
M05432	0.5	230	1.6	2.4	2.9	17.3	5.7 - 7.2
M07432	0.75		1.5	3.3	3.9	27	3.3 - 4.3
M10432	1		1.4	4.0	4.7	26.1	4.1-5.1
M15432	1.5		1.3	5.2	6.1	32.4	2.8-3.4
M20432	2		1.25	6.5	7.6	44	1.8-2.4
M30432	3		1.15	9.2	10.1	58.9	1.3-1.7
M50432	5		1.15	15.7	17.5	93	.85-1.25
M75432	7.5		1.15	24	26.4	140	.55-.85
M05434	0.5	460	1.6	1.3	1.5	9	23.6 - 26.1
M07434	0.75		1.5	1.7	2.0	14	14.4 - 16.2
M10434	1		1.4	2.2	2.5	13	17.8 - 18.8
M15434	1.5		1.3	2.8	3.2	16.3	12.3 - 13.1
M20434	2		1.25	3.3	3.8	23	8.0 - 8.67
M30434	3		1.15	4.8	5.3	30	5.9-6.5
M50434	5		1.15	7.6	8.5	48	3.58-4.00
M75434	7.5		1.15	12.2	13.5	87	1.9-2.3
M100434	10	DATA COMING END OF 2010					
M15437	1.5	575	1.3	2.0	2.4	11.5	19.8-20.6
M20437	2		1.25	2.7	3.3	21	9.4-9.7
M30437	3		1.15	3.7	4.1	21.1	9.4-9.7
M50437	5		1.15	7.0	7.6	55	3.6-4.2
M75437	7.5		1.15	9.1	10.0	55	3.6-4.2

CentriPro Motor Electrical Data

60 Hz, 3450 RPM GENERATION II - 2015

3Ø, 4", MOTOR DATA

Motor No.	HP	Volts	SF	FLA Amps	SFA Amps	Locked Rotor Amps	Line - Line Resistance
M05430	0.5	200	1.6	2.9	3.5	22	4.1 - 5.2
M07430	0.75		1.5	3.9	4.7	30	2.8 - 3.7
M10430	1		1.4	4.8	5.7	34	2.2 - 3.1
M15430	1.5		1.3	6.6	7.6	40	1.9 - 2.5
M20430	2		1.25	8.0	9.3	51	1.4 - 2.0
M30430	3		1.15	10.9	12.0	71	1.2 - 1.5
M50430	5		1.15	18.3	20.2	113	0.7 - 0.9
M75430	7.5		1.15	27.0	30.0	165	0.4 - 0.6
M05432	0.5	230	1.6	2.4	3.0	18	5.7 - 7.2
M07432	0.75		1.5	3.3	4.0	27	3.3 - 4.3
M10432	1		1.4	4.1	4.9	26	3.2 - 4.2
M15432	1.5		1.3	5.8	6.6	36	2.5 - 3.1
M20432	2		1.25	6.7	8.0	44	2.2 - 2.8
M30432	3		1.15	9.2	10.1	59	1.6 - 2.0
M50432	5		1.15	15.7	17.5	93	0.9 - 1.3
M75432	7.5		1.15	24.0	26.4	140	0.5 - 0.9
M05434	0.5	460	1.6	1.3	1.5	9	23.6 - 26.1
M07434	0.75		1.5	1.7	2.0	14	14.4 - 16.2
M10434	1		1.4	2.2	2.5	15	16.8 - 18.6
M15434	1.5		1.3	3.0	3.4	16	9.5 - 10.5
M20434	2		1.25	3.6	4.1	23	7.5 - 9.3
M30434	3		1.15	4.8	5.3	30	6.3 - 7.7
M50434	5		1.15	7.6	8.5	48	3.9 - 4.9
M75434	7.5		1.15	12.2	13.5	87	2.1 - 2.7
M100434	10	1.15	15.6	17.2	110	1.8 - 2.2	
M15437	1.5	575	1.3	2.3	2.6	15	15.6 - 17.3
M20437	2		1.25	2.7	3.3	21	10.2 - 12.5
M30437	3		1.15	3.7	4.1	21	10.2 - 12.5
M50437	5		1.15	7.0	7.6	55	3.6 - 4.2
M75437	7.5		1.15	9.1	10.0	55	3.6 - 4.2

75° C Cable, 60 Hz

(service entrance to motor)

Maximum Length in Feet

75° C Insulation - AWG Copper Wire Size

Motor Rating		14	12	10	8	6	4
Volts	HP						
230V 60 Hz 1Ø	5	0	100	170	260	430	680
	7.5	0	0	120	200	310	490
	10	0	0	0	140	220	340
	15	0	0	0	0	140	230
230V 60 Hz 3Ø 3 Lead	5	140	230	370	590	920	1430
	7.5	0	150	250	410	640	1010
	10	0	0	180	300	470	740
	15	0	0	0	200	320	510
	20	0	0	0	150	240	390
	25	0	0	0	0	190	310
	30	0	0	0	0	0	250
460V 60 Hz 3Ø 3 Lead	5	590	950	1500	2360	3700	5750
	7.5	410	670	1060	1670	2610	4060
	10	300	480	770	1220	1910	2980
	15	0	330	530	840	1320	2070
	20	0	0	400	640	1020	1600
	25	0	0	320	520	810	1280
	30	0	0	0	410	650	1030
	40	0	0	0	320	500	790
	50	0	0	0	0	390	610
	60	0	0	0	0	0	540
	75	0	0	0	0	0	430
	100	0	0	0	0	0	0
	125	0	0	0	0	0	0
	150	0	0	0	0	0	0
200	0	0	0	0	0	0	

Lengths **IN BOLD TYPE** meet the National Electric Code ampacity only for individual conductor 75° C cable, in

2	1/0	2/0	3/0	4/0	250	350	500
1060	1660	2070	2560	3190			
760	1150	1420	1740	2120			
520	810	1020	1250	1540			
370	560	700	870	1080			
2190	3290	4030	4850	5870	6650	8460	
1540	2310	2840	3400	4120	4660	5910	7440
1140	1720	2110	2550	3090	3510	4500	5710
790	1180	1450	1760	2120	2410	3080	3900
600	920	1130	1370	1670	1900	2440	3100
490	730	900	1100	1330	1510	1950	2480
390	590	730	890	1080	1230	1580	2030
6200							
4580	6900						
3160	4760	5840	7040				
2460	3710	4560	5500				
1960	2960	3640	4400	5350			
1570	2390	2940	3560	4330	4940		
1220	1840	2270	2730	3320	3760		
940	1430	1750	2110	2560	2910	3700	4690
830	1250	1540	1860	2250	2550	3260	4120
660	1000	1230	1480	1810	2050	2640	3360
490	750	930	1120	1360	1540	1990	2520
0	620	770	920	1040	1270	1620	2040
0	0	620	750	910	1040	1330	1680
0	0	0	610	740	840	1070	1370

free air or water. If other cable is used, the National Electric Code as well as the local codes should be observed.

Motor Lead Lengths - 3Ø Motors -

Based on S.F. Amps, 30° C Ambient and 5% Voltage Drop
60° C and 75° C Insulation - AWG Copper Wire Size

Motor Rating							
Volts	HP	kW	FLA	SFA	14	12	10
200	0.5	0.37	3.8	2.9	629	1000	1595
	0.75	0.55	3.8	4.5	423	674	1074
	1	0.75	4.6	5.5	346	551	879
	1.5	1.1	6.3	7.2	265	421	672
	2	1.5	7.5	8.8	217	344	549
	3	2.2	10.9	12.0	159	253	403
	5	3.7	18.3	20.2	94	150	239
	7.5	5.5	27.0	30.0	64	101	161
230	0.5	0.37	2.4	2.9	756	1202	1917
	0.75	0.55	3.3	3.9	562	894	1426
	1	0.75	4	4.7	466	742	1183
	1.5	1.1	5.2	6.1	359	571	912
	2	1.5	6.5	7.6	288	459	732
	3	2.2	9.2	10.1	217	345	551
	5	3.7	15.7	17.5	145	230	318
	7.5	5.5	24	26.4	96	152	243
460	0.5	0.37	1.3	1.5	2922	4648	7414
	0.75	0.55	1.7	2.0	2191	3486	5560
	1	0.75	2.2	2.5	1753	2789	4448
	1.5	1.1	2.8	3.2	1370	2179	3475
	2	1.5	3.3	3.8	1153	1835	2926
	3	2.2	4.8	5.3	827	1315	2098
	5	3.7	7.6	8.5	516	820	1308
	7.5	5.5	12.2	13.5	325	516	824
	10	7.5	-	-	310*	500*	790*
575	1.5	1.1	2.0	2.4	2283	3631	5792
	2	1.5	2.7	3.3	1660	2641	4212
	3	2.2	3.7	4.1	1336	2126	3390
	5	3.7	7.0	7.6	721	1147	1829
	7.5	5.5	9.1	10.0	548	871	1390

* Estimated

8	6	4	2	1/0	2/0	3/0	4/0
2562	3931						
1702	2648						
1392	2166	3454					
1064	1655	2638					
870	1354	2158	3427	5449			
638	993	1583	2513	3996			
379	590	940	1493	2374	2995	3781	4764
255	397	633	1005	1598	2017	2546	3207
3037	4725	7532					
2258	3513	5601	8892				
1874	2915	4648	7379				
1444	2246	3581	5685	9040			
1159	1803	2874	4563	7256	9155		
872	1357	2163	3434	5460	6889	8696	10956
503	783	1248	1982	3151	3976	5019	6323
334	519	827	1314	2089	2635	3327	4192
8806							
7045							
5504							
4635	7212						
3323	5171						
2072	3224	5140					
1305	2030	3236	5138				
1250*	1960*	3050*	4690*	7050*			
6671							
5370							
2897	4507						
2202	3426						

Units with 1Ø Input and 3Ø Output (Motors)

Maximum Cable Lengths in Feet to Limit Voltage Drop to 5% for 230 V Systems^⑤

Copper Wire Size 75°C Insulation Exposed to a Maximum of 50°C (122°F) Ambient Temperature^⑥

Service Entrance to Controller

Controller Input	Motor HP	14	12	10	8	6	4	2
		230V 1Ø	½	366	583	925	1336	2107
¾	279		445	706	1020	1608	2552	4019
1	226		360	571	824	1300	2064	3250
1½	*		286	455	657	1036	1644	2589
2	*		*	331	478	754	1197	1886
3	*		*	246	355	561	890	1401
5	*		*	*	218	343	545	858

Controller to Motor

Controller Output	Motor HP	14	12	10	8	6
		230V 3Ø	½	905	1442	2290
¾	690		1100	1748	2523	3978
1	558		890	1413	2040	3216
1½	445		709	1126	1625	2562
2	324		516	820	1184	1866
3	241		384	609	880	1387
5	*		235	373	539	849

⑤ Reduce lengths by 13% for 200 V systems.

⑥ Lengths in bold require 90°C wire. Shading indicates 40° C maximum ambient.

* Wire does not meet the N.E.C. ampacity requirement.

1/0	2/0	3/0	4/0	250	300	350	400	500
8364								
6383	8055							
5161	6513	8201						
4111	5188	6533	8236	9710				
2995	3779	4759	5999	7073	8455	9852		
2225	2808	3536	4458	5256	6283	7321	8343	
1363	1720	2165	2730	3219	3847	4483	5109	6348

4	2	1/0	2/0	3/0	4/0	250	300
8276							
6316	9945						
5106	8041						
4068	6406						
2963	4666	7410	9351				
2202	3467	5506	6949	8750			
1348	2123	3372	4255	5358	6755	7964	9520

To size wire, the voltage drop of each wire segment must be used and the total must not exceed 100%.

Example: a 1.5 HP motor, 100' from Service Entrance to Controller (1Ø wire) and 500' from Controller to Motor (3Ø wire).

- Service Entrance to Controller = 100' of # 10 (100/455) = 22 % (455' from 230V 1Ø chart)
- Controller to Motor = 500' of # 12 (500/709) = 71 % (709' from the 3Ø chart)
- 71% + 22% = 93%; See Balanced Flow Bulletin or IM182 for more info.

CentriPro 3Ø, 6" - 10", 1.15 S.F. Motors

CentriPro Order No.	HP	Volts	Rated Input Amps
6M058	5	200	17.5
6M052		230	15.0
6M054		460	7.5
6M078	7.5	200	25.4
6M072		230	22.0
6M074		460	11.0
6M108	10	200	33.3
6M102		230	29.0
6M104		460	14.5
6M158	15	200	47.4
6M152		230	42.0
6M154		460	21.0
6M208	20	200	61.2
6M202		230	54.0
6M204		460	27.0
6M258	25	200	77.3
6M252		230	68.0
6M254		460	34.0
6M308	30	200	91.8
6M302		230	82.0
6M304		460	41.0
6M404	40	460	56.0
66M504	50	460	70.0
86M504		460	65.0
86M604	60	460	80.0
8M754	75	460	96.0
8M1004	100	460	127.0
8M1254	125	460	161.0
8M1504	150	460	197.0
10M2004	200	460	235.0

CentriPro 3Ø, 6" - 10", 1.15 S.F. Motors – *Continued*

Service Factor Amps	Locked Rotor Amps	L-L Resistance
19.5	124	0.618
17.0	110	0.806
8.5	55	3.050
28.5	158	0.504
26.0	144	0.651
13.0	72	2.430
37.2	236	0.315
33.0	208	0.448
16.5	104	1.619
53.5	347	0.213
46.0	320	0.312
23.0	160	1.074
69.5	431	0.189
60.0	392	0.258
30.0	196	0.861
87.5	578	0.146
76.0	530	0.210
38.0	265	0.666
104.0	674	0.119
94.0	610	0.166
47.0	305	0.554
61.0	420	0.358
79.0	465	0.308
73.0	435	0.331
90.0	556	0.278
109.0	675	0.218
145.0	855	0.164
180.0	1122	0.132
220.0	1331	0.115
270.0	1260	0.0929

5-30 HP, 3Ø, 230 and 460 Motors have adjustable voltage feature, change voltage plugs to convert from 230V to 460V operation.

Voltage Plug Order No's are: PLUG-230V or PLUG-460V.

CentriPro 3Ø, 6" FM-Series Motors

Motor Order No.	HP	Volts	Full Load Amps
6F058	5	200-208	16.1
6F078	7.5		23.3
6F108	10		31.5
6F158	15		44.9
6F208	20		59.0
6F258	25		76.8
6F308	30		91.7
6F0524*	5	230	14.4
6F0724*	7.5		21.5
6F1024*	10		28.0
6F1524*	15		40.9
6F2024*	20		53.2
6F2524*	25		66.7
6F3024*	30		79.3
6F0524*	5	460	7.0
6F0724*	7.5		10.0
6F1024*	10		13.1
6F1524*	15		20.4
6F2024*	20		25.8
6F2524*	25		32.8
6F3024*	30		39.3
6F404	40		51.3
6F504	50		65.8
6F055	5		575
6F075	7.5	8.2	
6F105	10	10.5	
6F155	15	15.0	
6F205	20	20.9	
6F255	25	26.2	
6F305	30	31.0	
6F405	40	41.5	
6F505	50	53.0	

* Same motor with voltage change device supplied

CentriPro 3Ø, 6" FM-Series Motors – *Continued*

Service Factor Amps	Locked Rotor Amps	Line - Line Resistance
18.0	96	.86 - 1.1
26.8	140	.66 - .81
35.0	187	.37 - .46
50.8	268	.26 - .32
67.1	354	.19 - .24
86.5	445	.13 - .17
103.3	530	.10 - .13
16.1	87	1.1 - 1.4
24.1	127	.73 - .90
31.5	164	.50 - .62
46.3	237	.33 - .41
60.8	312	.25 - .31
76.0	387	.18 - .22
90.2	458	.15 - .19
8.0	44	4.4 - 5.4
11.3	62	2.9 - 3.6
14.8	82	1.9 - 2.4
23.0	117	1.1 - 1.4
29.4	151	.9 - 1.1
36.8	187	.69 - .85
44.6	226	.58 - .72
58.6	302	.45 - .56
75.1	385	.35 - .43
6.5	35	5.8 - 7.2
9.3	51	3.6 - 4.4
11.8	61	2.8 - 3.5
17.1	88	1.9 - 2.4
23.7	122	1.4 - 1.7
29.7	153	1.0 - 1.3
35.0	179	.83 - 1.0
47.3	247	.64 - .79
61.0	323	.53 - .71

CentriPro 3Ø, 8" FM-Series Motors

Motor Order No.	HP	Volts	Full Load Amps
86F504	50	460	65
86F604	60		78
8F504	50		65
8F604	60		78
8F754	75		95
8F1004	100		128
8F1254	125		165
8F1504	150		203
86F505	50	575	52
86F605	60		61
8F505	50		52
8F605	60		61
8F755	75		76
8F1005	100		100
8F1255	125		129
8F1505	150		159

CentriPro 3Ø, 8" FM-Series Motors – *Continued*

Service Factor Amps	Locked Rotor Amps	Line - Line Resistance
74	540	.19 - .24
89	645	.17 - .21
74	540	.19 - .24
89	645	.17 - .21
109	803	.12 - .15
146	1080	.08 - .11
188	1410	.06 - .08
228	1643	.04 - .06
60	439	.32 - .39
70	518	.26 - .32
60	439	.32 - .39
70	518	.26 - .32
88	645	.20 - .25
115	855	.16 - .20
148	1133	.10 - .13
178	1320	.08 - .10

1. To check: Shut off power supply and drain system to "0" pressure.
2. Air pre-charge in tank should be 2 psi less than the cut-in pressure of the pressure switch.

Example: If pressure switch setting is 30-50 psi, tank should be pre-charged with 28 lbs. air.

3. If water at valve, replace tank.



RULE OF THUMB

Improper tank sizing may cause motor damage.

½ to 1½ HP pumps - Tank draw down should be equal to the pump capacity in GPM or greater.

Example: ¾ HP pump; capacity 12 GPM; pressure switch setting 30/50 PSI; correct tank - V140.

2 HP and larger pumps - tank drawdown should be **double** the pump capacity in GPM.

Example: 3 HP pump; capacity 30 GPM; pressure switch setting 40/60 PSI; correct tank selection: 2 - V350 tanks.

Tank Volumes

Model No.	Total Volume (Gals.)	① Drawdown in Gals. at System Operating Pressure Range of			Maximum Drawdown Vol. (Gals.)
		18/40 PSIG	28/50 PSIG	38/60 PSIG	
V6P	2.0	0.8	0.7	0.6	1.2
V15P	4.5	1.8	1.5	1.3	2.7
V25P	8.2	3.3	2.8	2.4	4.5
V45P	13.9	5.6	4.7	4.1	8.4
V45B	13.9	5.6	4.7	4.1	8.4
V45	13.9	5.6	4.7	4.1	8.4
V60B	19.9	8.0	6.8	5.8	12.1
V60	19.9	8.0	6.8	5.8	12.1
V80	25.9	10.4	8.8	7.6	13.9
V80EX	25.9	10.4	8.8	7.6	13.9
V100	31.8	12.8	10.8	9.4	13.8
V100S	31.8	12.8	10.8	9.4	13.8
V140B	45.2	18.2	15.4	13.3	27.3
V140	45.2	18.2	15.4	13.3	27.3
V200B	65.1	26.2	22.1	19.2	39.3
V200	65.1	26.2	22.1	19.2	39.3
V250	83.5	33.6	28.4	25.6	50.8
V260	84.9	34.1	28.9	25.0	44.7
V350	115.9	46.6	39.4	34.1	70.5

① Drawdown based on a 22 psi differential and Boyle's Law. Temperature, elevation and pressure can all affect drawdown volume.



RULE OF THUMB

Tank must be sized to **allow a minimum run time per cycle** as follows:

$\frac{1}{3}$ - 1½ HP = 1 minute run time

2 HP & larger = 2 minute run time

Shallow Well

System illustrated is a Convertible jet pump with a shallow well adapter and a pressure tank.



RULES OF THUMB

- All jet pumps should be located at the highest point in the suction side of the system.
- (Distance from well head to pump) If offset is greater than 20' . . . increase horizontal pipes by one size each.
- Never use pipes smaller than the pump suction tappings.

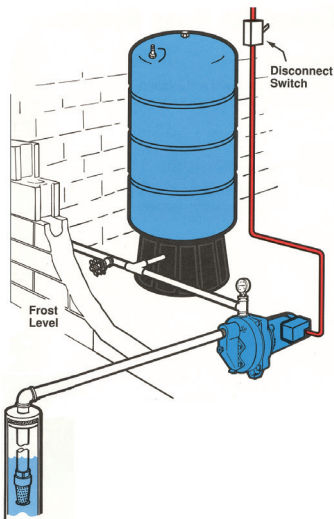

Deep Well

Packer and twin pipe systems



Single pipe deep well Packer Jet

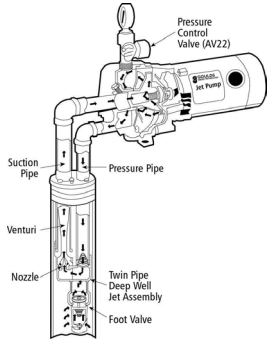

Improper Installations

- Trap air
- Hard to prime

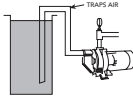

Proper Installations

- Easy to prime

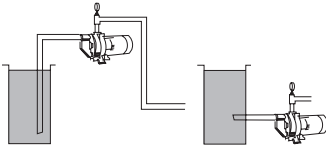

Jet Pump Disassembly . . .

1. Turn off power to motor. Disconnect service wires from pressure switch.
2. Drain system to relieve pressure.
3. Disconnect motor cord from pressure switch when used.
4. Remove casing bolts. If pump is mounted on top of tank, remove bolt holding motor adapter to mounting pad.
5. Disconnect tubing between casing or pressure control valve and pressure switch.
6. Remove motor, motor adapter casing, and rotating element. Casing remains attached to piping.
7. Remove guide vane seal ring and diaphragm gasket ring.
8. Remove guide vane from motor adapter (via 4 bolts or may be snap in type).
9. Remove motor end cover. Insert $\frac{7}{16}$ " open end wrench under switch mechanism or behind overload protector onto flats on motor shaft.

While holding the shaft against rotating, turn the impeller counterclockwise. The impeller should turn completely off the shaft in this manner.

10. Using two screwdrivers, pry out holding collar of mechanical seal assembly.
11. Motor adapter can be unbolted from the motor (for motor replacement).

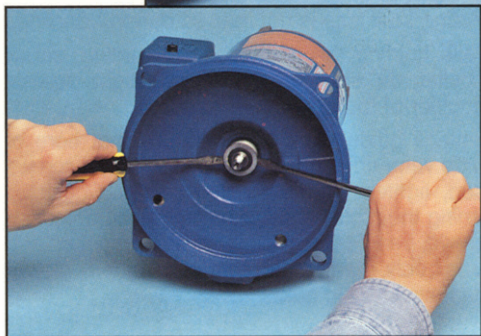
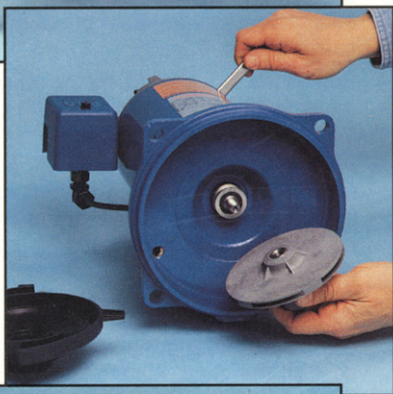
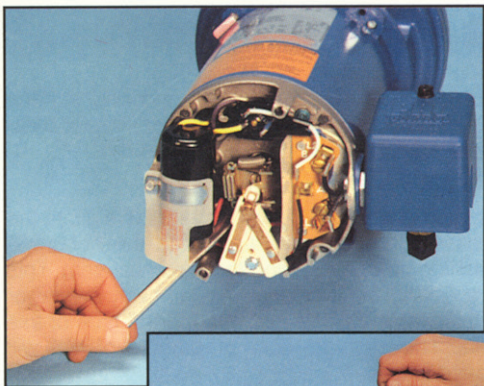

Jet Pump Reassembly . . .

- 1.** Be sure that recess for seal seat and surface where guide vane mounts on motor adapter are entirely free of all scale and dirt.
- 2.** Clean motor shaft.
- 3.** Apply film of light oil, such as vegetable oil, to the recess of the motor adapter and the neoprene bushing before installing the new seal seat. This is a tight fit, but it must go in all the way evenly, or a leak will result. Do not mar lapped face of this seal. The slightest scar or particle of dirt will cause a leak.
- 4.** Bolt motor adapter to motor, making sure the motor shaft does not dislocate the stationary seal member.
- 5.** Assemble rotating member of seal on motor shaft. Rotating seal face must fit snugly against lapped seal face of stationary member in casing cover. This is accomplished by pushing with a piece of tube against back end of neoprene washer after oiling sleeve and shaft. Be sure rotating seal face does not drop out of holding collar while sliding the rotating members of the seal on the shaft. Also, take extra care that the rotating seal face is not marred during handling.
- 6.** While holding the shaft against rotating, screw impeller on shaft by hand until tight against shoulder of motor shaft.
- 7.** Replace guide vane, making sure that bore of guide vane does not bind impeller hub. If screws used, tighten alternately and evenly. Check by turning the motor shaft. If binding occurs, loosen screws, readjust guide vane until impeller hub turns freely, then tighten screws as before. Some jets have snap-in guide vane.

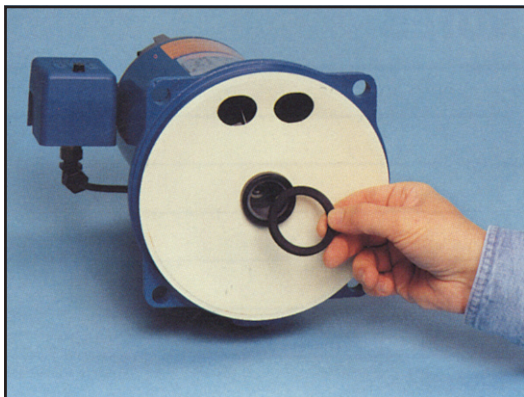

8. Replace diaphragm gasket with opening in the upper position.
9. Replace guide vane seal ring on guide vane hub.
10. Make sure all gasket surfaces are clean. Replace pump casing.
11. Tighten casing bolts alternately and evenly.
12. After reassembling pump, check to be sure impeller rotates freely.
13. Reconnect tube between pressure switch and casing cover or control valve.
14. Close all drain openings, using pipe joint compound or teflon tape on threads of plugs.
15. Prime according to Priming Instructions.



RULE OF THUMB

Do not start motor until pump and suction piping are filled with water.

An amprobe, ohmmeter and vacuum pressure gauge are essential for properly checking a system. Use of the amprobe and ohmmeter are explained in Amprobe/ Ohmmeter Instructions. Use of the compound vacuum pressure gauge is explained in Checking Suction Lift.

Find the basic problem for which numerous symptoms and possible solutions are given for each.



RULE OF THUMB

Remember there may be other system problems caused by auxiliary controls not covered in this booklet.

Pump Will Not Run . . .

Probable Cause	Recommended Action
1. Blown fuse or power turned off	Replace fuse - close all switches.
2. Broken or loose wiring connections.	Examine all wiring and repair any bad connections.
3. Motor overload protection contacts open. a. Improper voltage. b. Pump bound mechanically - will not turn freely.	Overload contacts will close automatically in a short time. See Volt Ammeter Remove motor end cap, turn motor shaft by hand. Unit should rotate freely.
4. Pressure switch faulty or out of adjustment.	Adjust or replace switch.
5. Tubing or fittings on pressure switch plugged.	Remove switch tubing and/or all fittings and clean.
6. Faulty motor.	See Jet pump ohmmeter checks.

Pump Runs But . . .

Little or no water delivered

Problem	Recommended Action
<p>1. Pump or pipes not completely primed.</p>	<p>Fill pump completely with water through priming opening (reprime pump).</p> <p>a. Deep Well system Control valve must be set properly or system will not pump. See Pressure Control Valves.</p>
<p>2. Foot valve or end of suction pipe either not submerged or buried.</p> <p>Foot valve in well or line check valve stuck closed.</p>	<p>a. Shallow Well system Install vacuum gauge See Checking Suction Lift.</p> <p>b. Deep Well system Physically check well conditions.</p> <p>Replace foot valve if necessary. (Very high vacuum, 22 inches or more. see Checking Suction Lift.)</p>
<p>3. Leaks on suction side of pump (Very common problem.)</p>	<p>Pressurize system and inspect.</p>

Pump Runs But . . .

Problem	Recommended Action
<p>4. Jet assembly plugged.</p>	<p>A. Shallow Well system Clean if necessary (Insert wire through ½" plug in shallow well adapter.)</p> <p>b. Deep Well system Pull jet assembly and clean.</p>
<p>5. Punctured diaphragm in air control. Galvanized tanks.</p>	<p>Disconnect the tubing and plug the connection in pump. If this corrects the trouble, the air control must be replaced.</p>
<p>6. Original installation, incorrect nozzle or diffuser combination.</p>	<p>Check rating in product catalog.</p>

Pump Runs But . . .

Pump starts and stops too often . . .

Problem	Recommended Action
1. Leaks in piping system.	Pressurize piping system and inspect. Repair or replace.
2. Faulty pressure switch.	Check contact points. Adjust or replace switch.
3. Waterlogged galvanized tank, faulty air control.	Pumps using Brady control: Test by holding your ear on air control. If control is operating, air can be heard passing from control into tank when pump stops. If no air movement is heard, air control should be replaced.
4. Leaking tank or air valve.	Use soapy water to find leaks. Repair or replace.
5. Not enough suction lift on shallow well system - water flows into pump (flooded suction).	Throttle suction line with partially closed valve.
6. Insufficient vacuum or vacuum does not exist for long enough time to operate air control.	Pump requires minimum 3" vacuum for 15 seconds.
7. Improper air change in captive air tank.	See tank checkout.
8. Tank too small for pump. for pump.	Replace with proper size storage tank.

Pump Runs But . . .

Pumps water, but does not develop 40 lbs. tank pressure. . .

Problem	Recommended Action
1. Leaks in well piping or discharge pipe.	Pressurize piping system and inspect.
2. Jet or screen on foot valve partially plugged.	Clean if necessary.
3. Improper pressure control valve setting (deep well only).	See Pump IOM
4. Suction lift too high for shallow well system. a. Jet set too deep for deep well system.	Use vacuum gauge on shallow well systems Vacuum should not exceed 22 inches at sea level. On deep well system check ratings tables in catalog for maximum jet depth.
5. Faulty air charger.	Disconnect the tubing and plug the hole. If this corrects the trouble, the air control must be replaced.
6. Worn impeller hub and/or guide vane bore.	Replace if necessary. Clearance should not exceed .012 on a side or .025 diametrically.
7. Overpumping the well.	Throttle a valve on the pump suction - do not exceed 22" Hg.

Pump Runs But . . .

Pump develops 40 lbs. pressure, but switch does not cut out . . .

Problem	Recommended Action
1. Pressure switch incorrectly set.	See Switch Adjustment.
2. Tubing or fittings between switch and pump plugged.	Remove switch tubing and/or all fittings and clean.
3. Faulty switch or corroded contact points.	Replace if necessary.

Switch Chatter . . .

Problem	Recommended Action
1. Caused by pressure differential between switch and tank. Equivalent feet of pipe should be less than 4' to prevent chatter. Friction loss of fittings can add many feet of equivalent pipe, ex. a ¾" - 90° elbow = 2' of pipe; 1" 90 = 2.7'. See TTECHWP Tech Manual for pipe fitting equivalents.	Move pressure switch to tank cross tee or mount in a discharge tee near pump.
2. High volume flows can cause switch chatter	Contact switch supplier (not pump mfg) for a pressure pulsation plug - they have very small holes which can easily plug with dirt and sand - use only if absolutely nothing else works and water is clean.

How to Use Volt-Ammeter



CAUTION

Power is **ON** during voltage checking.

1. Attach leads to volt-ammeter and select proper voltage scale for voltage to be tested.
2. Place leads in A position to test for presence of incoming voltage.
 - Voltage should be within + 10% of the design voltage specified on the motor nameplate in A, B and C test positions.
3. With disconnect switch in ON position, move leads to B position and test voltage flow through fuse(s).
4. The C position tests voltage at pressure switch terminals. The voltage should be within limits with the motor operating.

Voltage Limits

Nameplate ▼	Measured Volts	
	Min.	Max.
115V 1Ø	105	125
208V 1Ø	188	228
230V 1Ø	210	250

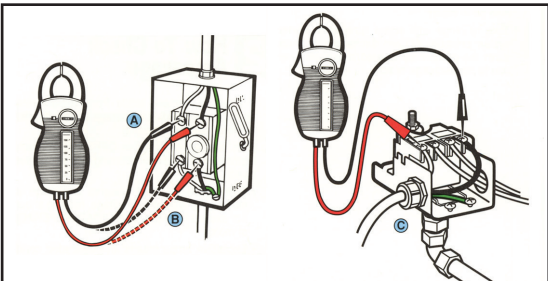

**WARNING!**

Power is ON during voltage checking.

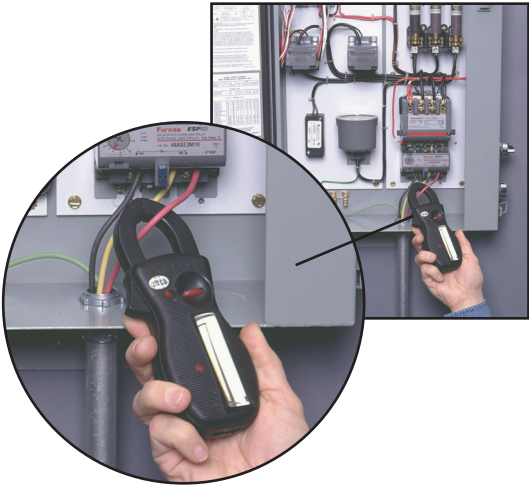
**Using Amprobe**

1. Set scale to highest amp range.
2. Connect amprobe around lead as shown.
3. Rotate scale to proper range and read value.
4. Compare value with table.

What It Means -

Currents above these values indicate system problems.

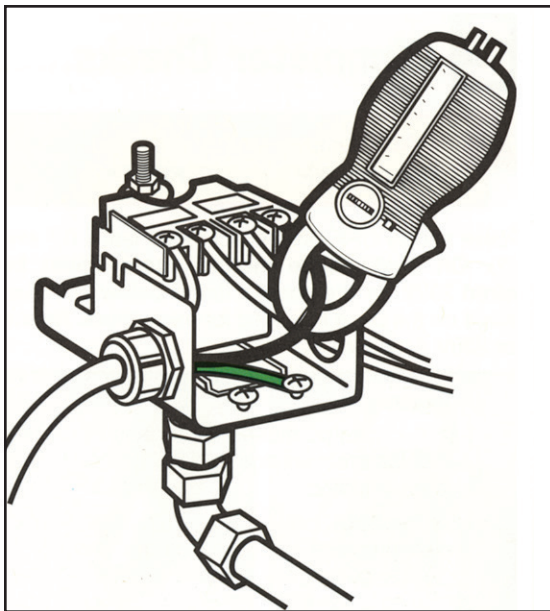

CAUTION

Power is ON during amperage testing.



CAUTION

Use ohmmeter only with **POWER OFF**.

Power supply OFF. Disconnect motor leads (L1 and L2). **On dual-voltage motors, motor must be wired 230V for the checks listed below** and illustrated on the page indicated for each check. Rewire for 230V if necessary.

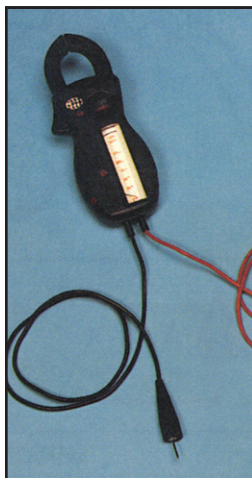
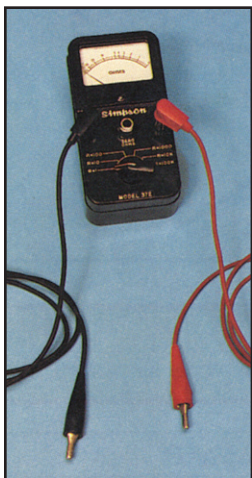

CHECK:	Page
a. Ground.....	78
b. Winding Continuity	79-81
c. Contact Points (Switch)	82
d. Overload Protector.....	83-85
e. Capacitor	86

Ground Check



CAUTION

Disconnect Power Source before checking.

- a. Set ohmmeter to $R \times 1,000$.
- b. Attach one probe to ground screw and touch other probe to all terminals on terminal board, switch, capacitor and protector - any ohmmeter reading indicates ground.

If digital meter is used, the reading should be at least one megohm.

- c. If grounded, check all external leads for cuts, breaks, frayed wires, etc. Replace damaged leads and recheck for grounds and proper lead routings. **Make sure replaced leads are not pinched between canopy and end bell.**

If ground is in stator, replacement of motor is recommended.

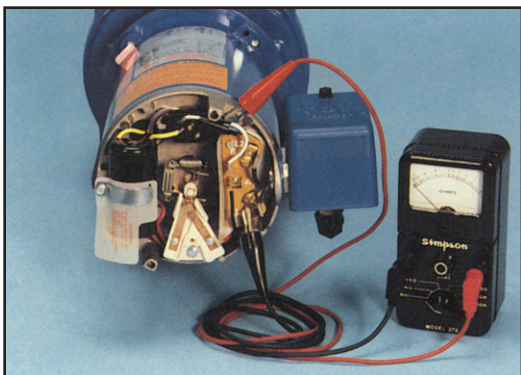

Winding Continuity - A.O. Smith / Century Motor



CAUTION

Disconnect Power Source before checking.

1. Terminal board connected for 230 V.
2. Set ohmmeter to R x 1, adjust to 0.
3. Slip a heavy piece of paper between motor switch points, discharge the capacitor and take the following ohm readings:
 - a. Resistance between L1 and A must be the same as between A and yellow.
 - b. Yellow to red (winding side of switch) must be the same as L1 to same red terminal.

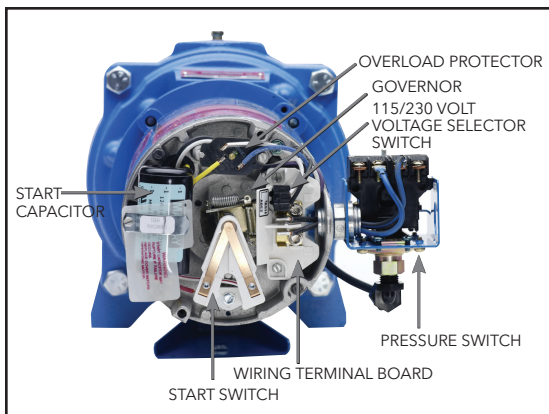

L1 = Blue wire

L2 = White wire

A = Purple wire

Ohmmeter tests on the new style terminal board with the quick-change voltage selector switch, see picture on pg. 76 (Black plastic part with 2 wires in it) is simplified if your ohmmeter is equipped with the sharp, pointed probes rather than alligator clips. With the voltage change plug on the 230 volt terminal the Black wire in the plug is positioned on Terminal "A". Simply touch one ohmmeter probe on the Black wire in the voltage change plug to get the "A" terminal reading. Another method is to remove the terminal board screws and place the alligator clip on the wire on the bottom side of Terminal "A".

Old Style (Brown) Terminal Board Wiring

A.O. SMITH MOTOR WIRING	
<p>115 Volt Black (from motor) on L1</p> <p>Black/White (Black tracer from overload) on A</p>	<p>230 Volt Black (from motor) on A</p> <p>Black/White (Black tracer from overload) on B</p>

Winding Continuity - US Motor



CAUTION

Disconnect Power Source before checking.

1. Terminal board connected for 230 V.
2. Set ohmmeter to R x 1, adjust to 0 (NOTE: Digital meters are typically used, the reading on this equipment should be showing OL or infinity).
3. Discharge the capacitor and take the following ohm readings:
 - a. Measure resistance between L1 and L2 on switch, this measures Main and Aux. winding continuity.
 - b. Measure resistance between L1 and L2 on switch, depress the actuator sleeve and this removes Aux. from circuit giving continuity of Main winding only.

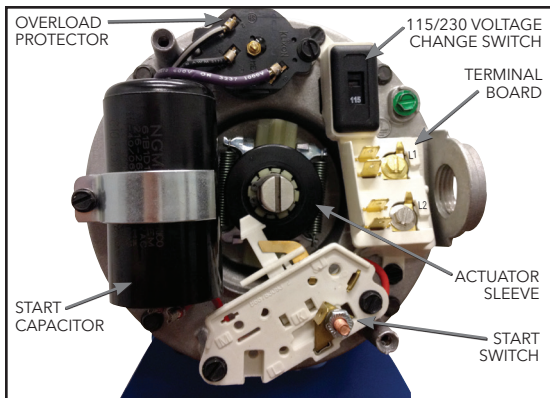

Contact Points (Start Switch)



CAUTION

Disconnect Power Source before checking.

1. Set ohmmeter to R x 1, adjust to 0.
2. Remove leads from start switch.
3. Attach ohmmeter leads to each side of switch - reading should be 0.
4. Flip governor weight to run position. Reading should be infinity.

A.O. Smith / Century Motor Overload Protector



CAUTION

Disconnect Power Source before checking.

1. Set ohmmeter to R x 1, adjust to 0.
2. Disconnect the overload leads.
3. Check resistance between terminals 1 and 2, then 2 and 3. If either reading is higher than 1, replace the overload.

1 = Blue wire

2 = Black/
white wire

3 = Yellow wire

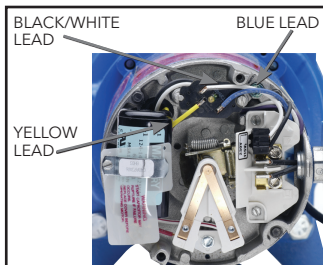

Motor Overload Protector - US Motor



CAUTION

Disconnect Power Source before checking.

1. Set ohmmeter to R x 1, adjust to 0 (NOTE: Digital meters are typically used, the reading on this equipment should be showing OL or infinity)
2. Disconnect the Overload protector leads
3. Check Resistance between terminals 1 and 2, then 2 and 3. If readings is higher that 1, replace the overload.

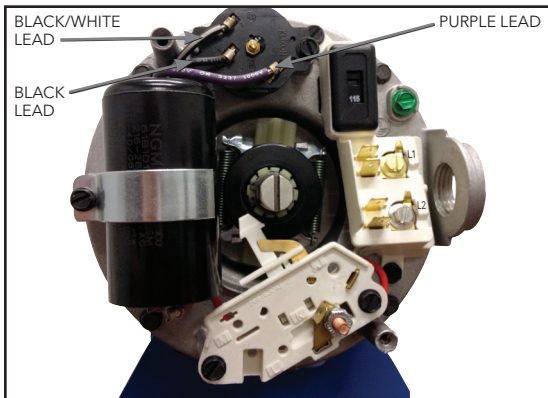

- Terminal 1 = Purple wire
Terminal 2 = Black/White wire
Terminal 3 = Black Wire

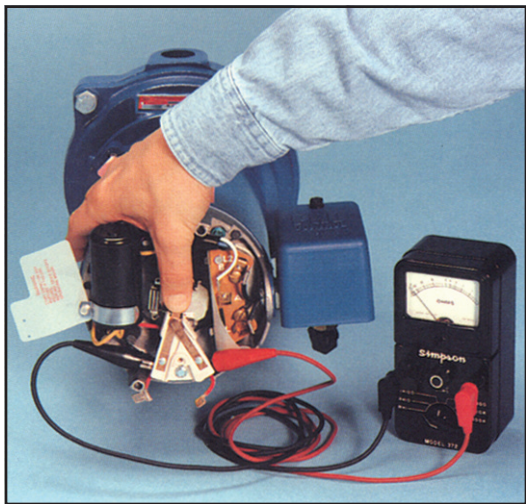
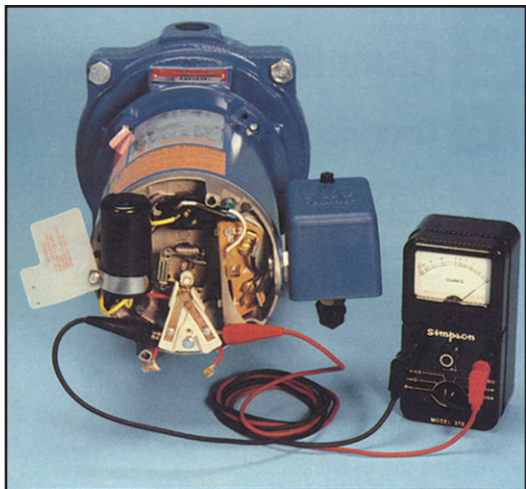



Capacitor



CAUTION

Disconnect Power Source before checking.



IMPORTANT

Discharge capacitor by touching the two terminals with the blade of an insulated handle screwdriver.

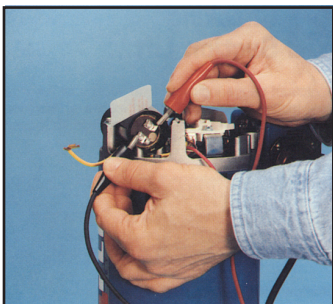

1. Set ohmmeter to R x 1,000, adjust to 0.
2. Disconnect leads on capacitor.
3. Attach ohmmeter leads to each terminal. Needle should swing to right and drift slowly to left. To double check, switch ohmmeter leads and repeat procedure.
If the needle will not move or moves toward 0 and stays there, the capacitor is bad.
4. If a digital meter is used, readings should start low and rapidly increase to maximum value.

Adjust in proper Sequence:

1. CUT-IN: Turn range nut down for higher cut-in pressure, or up for lower cut-in.
2. CUT-OUT: Turn differential nut down for higher cut-out pressure, or up for lower cut-out.

Note: Adjustment to range (cut-in) nut will also change cut-out pressure.

**CAUTION**

To avoid damage, do not exceed maximum allowable system pressure. Check switch operation after re-setting.

CentriPro or Square "D" Switches

Adjust in proper sequence:

1. CUT-IN: Turn nut down for higher cut-in pressure, or up for lower cut-in.
2. CUT-OUT: Turn nut down for higher cut-out pressure, or up for lower cut-out.

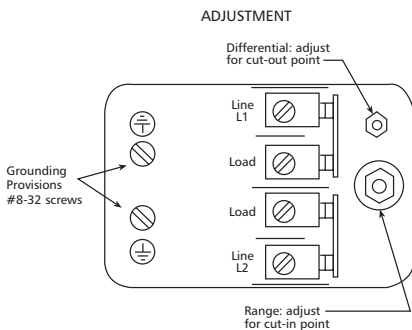

A vacuum gauge indicates total suction lift (vertical lift + friction loss = total lift) in inches of mercury. 1" on the gauge = 1.13 ft. of total suction lift (based on pump located at sea level).



RULE OF THUMB

Practical suction lift at sea level is 25 ft. Deduct 1 ft. of suction lift for each 1,000 ft. of elevation above sea level.

Shallow Well System

Install vacuum gauge in shallow well adapter. See opposite page. When pump is running, the gauge will show no vacuum if the end of suction pipe is not submerged or there is a suction leak. If the gauge shows a very high vacuum (22 inches or more), this indicates that the end of suction pipe is buried in mud, the foot valve or check valve is stuck closed or the suction lift exceeds capability of pump.



High Vacuum (22 inches or more)

- Suction pipe end buried in mud
- Foot valve or check valve stuck closed
- Suction lift exceeds capability of the pump



Low Vacuum (or 0 vacuum)

- Suction pipe not submerged
- Suction leak



Compound Vacuum Pressure Gauge

This gauge will show the pressure or vacuum at any position in a pump or system where it is installed.

A reading of 20" on a vacuum gauge placed on the suction side of the pump would tell you that you have a vacuum or suction lift of 22.6 ft.

$$20" \times 1.13' = 22.6 \text{ ft.}$$

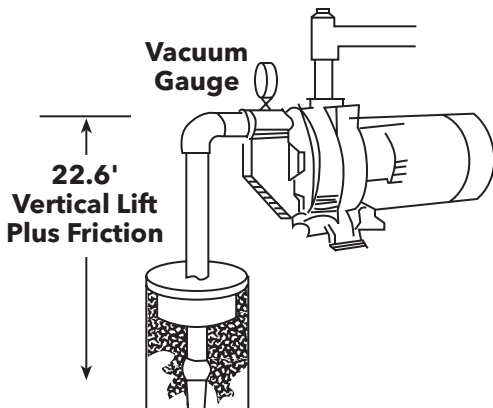

When pump is first started or under maximum flow condition, pressure control should be immediately adjusted to the pressure corresponding to H.P. and jet assembly used. See rating tables in catalog for proper pressure setting.

1. Turn left to reduce pressure.
2. Turn right to increase pressure.



RULE OF THUMB

If pressure control valve is set too high, the air volume control will not function.

If pressure control valve is set too low, the pump may not shut off.

To Adjust Pressure Control Valve:

1. Close pressure control valve.
2. Open faucet in house.
3. Turn pump on.
4. As pump picks up its prime, the pressure will begin to rise on the gauge.
5. Turn adjusting screw to set pressure control valve to pressure recommended in catalog.

Correct rotation is a must on all 3Ø installations. Rotation can be checked by one of these three ways:

Visual 1

1. Connect 3 motor leads to starter, run unit at open discharge.
2. Switch any 2 leads and again run unit at open discharge.
3. Largest quantity of water indicates correct rotation.

Visual 2

Remove water end from meter. Run motor and observe rotation

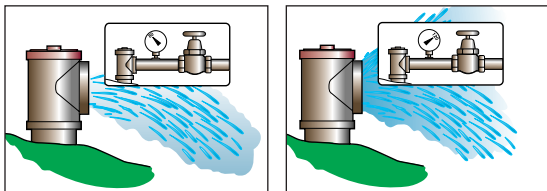

Pressure

1. Connect 3 motor leads to starter. Run unit against closed discharge, take maximum pressure reading.
2. Switch any 2 leads and again run unit against closed discharge. Take maximum pressure reading.
3. Highest pressure reading indicates correct rotation.



WARNING!

Prolonged reverse rotation operation can cause pump/motor damage.

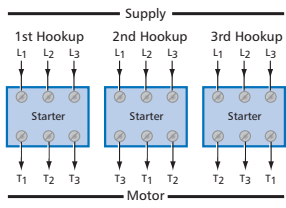
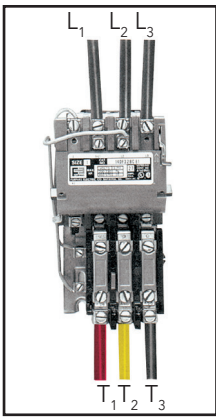
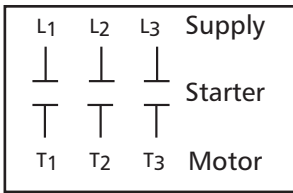

For the best protection, we recommend no more than a 5% current deviation from average current. Current readings in amps should be checked on each leg using the three possible hookups.

CAUTION

To prevent changing motor rotation, the motor leads should be reordered in the same direction, see example on page 53.

RULE OF THUMB

If the unbalance moves with the motor leads the unbalance is caused by the motor, wet splice, or damaged cable. If the unbalance remains with the terminals the unbalance is in the power supply.

Calculate percentage of current unbalance for all three hookups.

Example:

Hook Up 1	Hook Up 2	Hook Up 3
T ₁ = 51 Amps	T ₃ = 50 Amps	T ₂ = 50 Amps
T ₂ = 46 Amps	T ₁ = 48 Amps	T ₃ = 49 Amps
T ₃ = 53 Amps	T ₂ = 52 Amps	T ₁ = 51 Amps

Add up all three readings for hook up number 1.

$$\begin{array}{r} T_1 = 51 \text{ Amps} \\ T_2 = 46 \text{ Amps} \\ +T_3 = 53 \text{ Amps} \\ \hline \end{array}$$

Total 150 Amps

Divide the total by three to obtain the average.

$$\begin{array}{r} \mathbf{50 \text{ Amps} = \text{Average}} \\ 3 \overline{)150 \text{ Amps}} \end{array}$$

Calculate the greatest amp difference from the average. Could be greater than average.

$$\begin{array}{r} 50 \text{ Amps} \\ -46 \text{ Amps} \\ \hline \mathbf{4 \text{ Amps}} \end{array}$$

Divide this difference by the average to obtain the percentage of unbalance.

$$\begin{array}{r} \mathbf{.08 \text{ or } 8\%} \\ 50 \overline{)4.00 \text{ Amps}} \\ \text{Hook Up \#1} = 8\% \\ \text{Hook Up \#2} = 4\% \\ \text{Hook Up \#3} = 2\% \end{array}$$

Always use hook up with lowest % current unbalance. Loads on a transformer bank vary. Readings should be taken at peak load period.

What It Means -

1. Hook ups below 5% = system balanced.
2. Hook ups not below 5% - if the unbalance moves with the motor leads the unbalance is caused by the motor, wet splice, or damaged cable. Check the motor on pages 44-45. If the unbalance remains with the terminals the unbalance is in the power supply - contact power company.

A full 3Ø supply is recommended for all 3Ø motors, consisting of three individual transformers or one 3Ø transformer. "Open" delta or wye connections using only two transformers can be used, but are more likely to cause problems from current unbalance.

Transformer ratings should be no smaller than listed in the table for supply power to the motor alone.

Transformer Capacity Required for Submersible Motors

Submersible 3Ø Motor HP Rating	Total 3Ø Motor HP Rating	Smallest KVA Rating - Each Transformer	
		Open WYE or Delta 2 Transformers	WYE Delta 3 Transformers
1.5	3	2	1
2	4	2	1.5
3	5	3	2
5	7.5	5	3
7.5	10	7.5	5
10	15	10	5
15	20	15	7.5
20	25	15	10
25	30	20	10
30	40	25	15
40	50	30	20
50	60	35	20
60	75	40	25
75	90	50	30
100	120	65	40
125	150	85	50
150	175	100	60
175	200	115	70
200	230	130	75

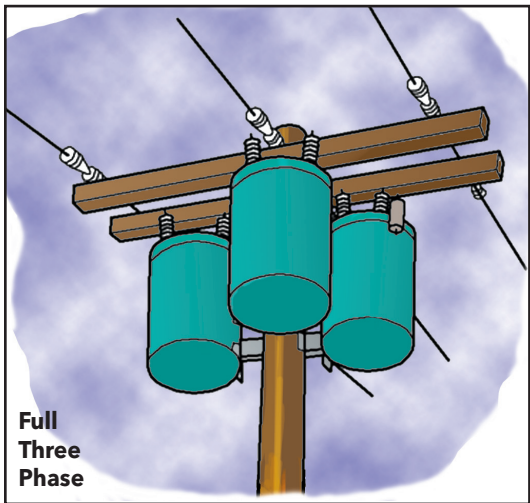
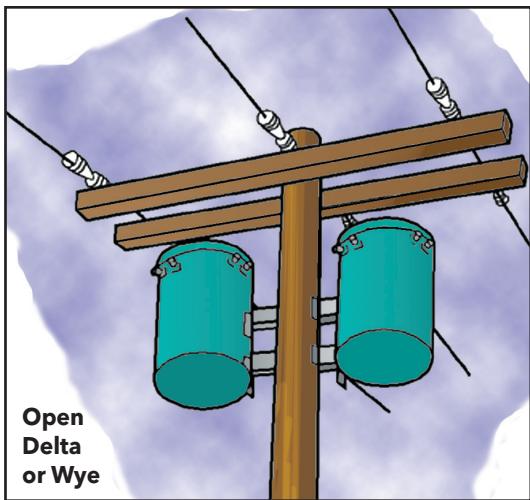

Aquavar SOLO² - Quick Installation Guide

- 1. Mount Drive** (in a vertical position);
 - Must have 6" minimum clearance on all sides for proper cooling.
- 2. Connect Input Power Wire** (Single Phase, 230V, Size Wire Ampacity for 75°C Copper Wire)
 - Review Circuit Breaker Sizing see IMS-SOLO2Q-2 or IM260
- 3. Wire Motor Drop Cable** (Size Wire Ampacity for 75°C Copper Wire)
 - 3AS Models - Use with Three Phase, 230V, ¾ to 5 HP Motors
 - 1AS15 Model - Compatible with Single Phase, 230V Motors
 - 3-Wire - .5 - 2 HP CentriPro / Pentek XE; .5 - 1.5 HP Franklin Electric and Grundfos
 - 2-Wire - .5 - 1.5 CentriPro, Pentek XE, Franklin Electric and Grundfos 2-Wire
 - Review Wire Sizing (Table 4 of IM260)
- 4. Mount Transducer and Connect Transducer Cable Wiring**
 - Transducer cable maximum length = 200 feet
 - Connect Pressure Transducer to piping manifold and to ground
- 5. User Interface Board Adjustments**
 - Select proper "Current Limit Setting" (equal to motor SFA)
 - 1AS15 Only - Set "Pump Stop Sensitivity" - High 40 Hz is Default
 - 3AS-- Only - Select maximum frequency setting (60 Hz or 80 Hz);
 - 60 Hz = matching Liquid End HP and Motor HP
 - 80 Hz = "over-speed" application; motor HP is greater than Liquid End HP (typically 2x larger)
 - Dry Well Sensitivity - Set on "High" position;
 - If nuisance tripping occurs, switch to "Low" position
 - Low Pressure Cut-Off and Pressure Drop setting adjusted to application / system requirements.
 - Optional use of Run/Stop Input, Setpoint Select Input and Relay Output, refer to IM260
- 6. Adjust Tank Pressure**
 - Set approximately 20 PSI below pressure Setpoint
 - Adjust as needed to optimize - see IMS-SOLO2Q-2 or IM260
- 7. Turn Drive Power On - Adjust Pressure - Purge Air**
 - Purge air from system and check for leaks
 - Factory default is 60 psi for Setpoint 1 and 70 psi for Setpoint 2- push and hold Increase Pressure button if higher pressure is desired and also adjust tank pre-charge.
 - Setpoint Select Input Terminal is used to switch from 2 different pressure Setpoints, refer to IM260.
- 8. Check Motor Rotation and Confirm Performance**

Refer to Aquavar SOLO² Installation Manual, IM260, for complete details.
Check Motor Insulation Resistance on retrofit jobs before replacing drive.

Aquavar SOLO² - User Interface Board

1AS Controllers

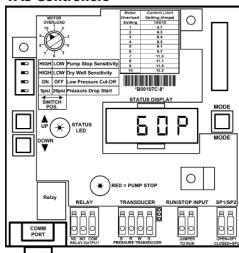

3AS Controllers

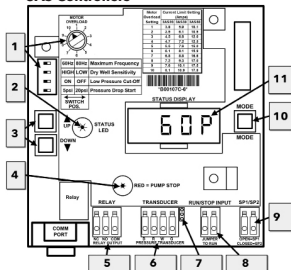

- | | | |
|----------------------------------|----------------------|----------------------------------|
| 1) Basic Drive Settings | 5) Relay Output | 9) Setpoint Select Input |
| 2) Controller Status Indicator | 6) Transducer Input | 10) Display Mode Adjust |
| 3) Setpoint and Parameter Adjust | 7) Transducer Jumper | 11) Status and Parameter Display |
| 4) Run/Stop Indicator | 8) Run/Stop Input | |

Service Factor Amps - All Motors

HP	230 Volt									200 Volt	
	10 2-Wire			10 3-Wire			30			30	
	CentriPro ¹	Franklin	Grundfos	CentriPro	Franklin	Grundfos	CentriPro	Franklin	Grundfos	CentriPro	Franklin
1/2	4.7/4.7	6	6	6.3	6	6	N/A	N/A	N/A	N/A	N/A
3/4	6.4/6.2	8	8.4	8.3	8	8.4	3.9	3.8	N/A	4.5	4.4
1	9.1/8.1	9.8	9.8	9.7	9.8	9.8	4.7	4.7	N/A	5.5	5.4
1 1/2	11.0/10.4	13.1 ²	13.1 ²	11.1	11.5	11.6	6.1	5.9	7.3	7.2	6.8
2	N/A	N/A	N/A	12.2	13.2 ²	13.2 ²	7.6	8.1	8.7	8.8	9.3
3	N/A	N/A	N/A	N/A	N/A	N/A	10.1	10.9	12.2	12	12.5
5	N/A	N/A	N/A	N/A	N/A	N/A	17.5	17.8	19.8 ²	20.2 ²	20.5 ²

1. CentriPro 2-Wire motors have Generation 1 and Generation 2 amp ratings, see motor nameplate or motor data sticker that was supplied with motor.
 2. Amps are higher than controller overload range - use of these motors will current limit and provide reduced performance.

Pressure Ranges for All Available Transducers

Transducer	1AS15 / 3AS20		3AS30		3AS50	
	(Min. PSI)	(Max. PSI)	(Min. PSI)	(Max. PSI)	(Min. PSI)	(Max. PSI)
100 PSI ⁽¹⁾	20	85	20	85	10	50
200 PSI ⁽²⁾	40	170	40	170	20	100
300 PSI	60	255	60	255	30	150

(1) Standard on 1AS15, 3AS20 and 3AS30

(2) Standard on 3AS50

Aquavar AB2 Quick Start Guide

Installation Steps:

1. Install the Pump

- Plumb suction and discharge of pump into piping.
- Install a check valve on the suction side.
- Locate the pump as near liquid source as possible.

2. Install the Pressure Transducer

- Install the pressure transducer in the tank tee provided with the unit.
- Locate the transducer within 120" of the controller.

3. Mount the Controller

- Mount vertically in a well ventilated, shaded area with 8 inches of free air space on every side and temperature between 34° F and 104° F.

4. Connect Input Power

- Connect the 1Ø power from a 20 amp 2-pole circuit breaker.
- Do not use GFCI protection with AB2 as nuisance tripping will result.

5. Output Power Connections

- Connect the output power leads from the controller to the 3 motor leads in the conduit box on the motor.

6. Set the motor Overload Switches (or dials, 3 and 5 HP)

- Complete systems have overloads pre-set at factory.

7. Set the Pressure - Factory pre-set is 50 PSI

- Push and Hold the Increase or Decrease Pressure Adjust Pushbutton until the desired pressure setting is reached.
- The maximum allowable pressure setting is 85 psi.

8. Set the Application Switches (or dials, 3 and 5 HP)

- Minimum Speed of 10 Hz - the incoming pressure is within 20 PSI of the desired pressure setting.
- Minimum Speed of 30 Hz - the incoming pressure is 20 PSI or more below the desired pressure, if pumping from a tank or if drawing a suction lift.
- Ramp Speed - Slow - Low flow; Medium - Medium flow; Fast - High flow

S-Drive Quick Start Up Guide

- Step 1:** Mount drive on secure wall or support beam using 4 screws. Ensure drive is well ventilated. Leave at least 8" of free space around the controller for cooling. Plug conduit holes not used.
- Step 2:** Measure site voltage phase-phase and phase-ground; verify incoming voltage is 1Ø or 3Ø 230V, or 3Ø 460V. make sure all phase-ground voltages are equal. Models SPD2XXXX(F) require 230V input voltage. Models SPD4XXXX(F) require 460V input voltage.
- Step 3:** Provide a dedicated fused disconnect (item #2 above) or circuit breaker rated for drives input amps. No other equipment should be used for this disconnect. Use fast acting class T fuses.
- Step 4:** Connect wire from input power supply to L1, L2, L3 and GND. NOTE: For single phase supply power, wire to L1 and L3 and adjust overload switches for 50% of drive current rating. Ensure you have a solid ground from the building or site. Ensure the ground is continuous between the service entrance and the controller. Ensure there is at least 8" between the input wires and any other wires.
- Step 5:** Ensure you have a three phase motor. Connect motor leads to T1/U, T2/V, T3/W and GND. Ensure the ground is continuous between the controller and the motor. For CentriPro motors, connecting T1/U to Red, T2/V to Black and T3/W to Yellow will give the correct rotation. To change rotation, swap any two motor leads T1/U, T2/V or T3/W. Ensure there is at least 8" between the output wires and any other wires.
- Step 6:** Plumb pressure transducer in straight piece of pipe downstream of last check valve in system. Do not install the pressure transducer or pressure tank where freezing can occur. If pressure transducer is placed in grounded metal piping, disconnect the drain wire in the pressure transducer cable from the controller chassis.
- Step 7:** Pre-charge bladder tank to 10-15 PSI below your system pressure. Tank capacity should be at least 20% volume of maximum pump GPM.
- Step 8:** Set the Motor Overload Setting Switches. Choose a setting that is equal to or less than the motor's SFA rating.
- Step 9:** Factory pressure setting is 50 PSI when used with a 300PSI transducer. Press and hold INC or DEC button to adjust pressure while pump is running. Ensure drive goes into stand-by mode (solid green light/pump off) to save pressure setting.

NOTE: Do not connect power to CONTROL TERMINALS. Connect only non-powered switch contacts to these terminals.

addresses & phone

Company _____

Contact _____

Address _____

City _____ State _____ Zip _____

Phone _____ Fax _____

Company _____

Contact _____

Address _____

City _____ State _____ Zip _____

Phone _____ Fax _____

Company _____

Contact _____

Address _____

City _____ State _____ Zip _____

Phone _____ Fax _____

Company _____

Contact _____

Address _____

City _____ State _____ Zip _____

Phone _____ Fax _____

Company _____

Contact _____

Address _____

City _____ State _____ Zip _____

Phone _____ Fax _____

Company _____

Contact _____

Address _____

City _____ State _____ Zip _____

Phone _____ Fax _____

addresses & phone

Company _____

Contact _____

Address _____

City _____ State _____ Zip _____

Phone _____ Fax _____

Company _____

Contact _____

Address _____

City _____ State _____ Zip _____

Phone _____ Fax _____

Company _____

Contact _____

Address _____

City _____ State _____ Zip _____

Phone _____ Fax _____

Company _____

Contact _____

Address _____

City _____ State _____ Zip _____

Phone _____ Fax _____

Company _____

Contact _____

Address _____

City _____ State _____ Zip _____

Phone _____ Fax _____

Company _____

Contact _____

Address _____

City _____ State _____ Zip _____

Phone _____ Fax _____

addresses & phone

Company _____

Contact _____

Address _____

City _____ State _____ Zip _____

Phone _____ Fax _____

Company _____

Contact _____

Address _____

City _____ State _____ Zip _____

Phone _____ Fax _____

Company _____

Contact _____

Address _____

City _____ State _____ Zip _____

Phone _____ Fax _____

Company _____

Contact _____

Address _____

City _____ State _____ Zip _____

Phone _____ Fax _____

Company _____

Contact _____

Address _____

City _____ State _____ Zip _____

Phone _____ Fax _____

Company _____

Contact _____

Address _____

City _____ State _____ Zip _____

Phone _____ Fax _____

addresses & phone

Company _____

Contact _____

Address _____

City _____ State _____ Zip _____

Phone _____ Fax _____

Company _____

Contact _____

Address _____

City _____ State _____ Zip _____

Phone _____ Fax _____

Company _____

Contact _____

Address _____

City _____ State _____ Zip _____

Phone _____ Fax _____

Company _____

Contact _____

Address _____

City _____ State _____ Zip _____

Phone _____ Fax _____

Company _____

Contact _____

Address _____

City _____ State _____ Zip _____

Phone _____ Fax _____

Company _____

Contact _____

Address _____

City _____ State _____ Zip _____

Phone _____ Fax _____

TECHNICAL HOTLINES

Wastewater - 866-672-3669

Residential Jets and Subs - 866-673-0427

Commercial Centrifugal - 866-673-0428

VFD Controls - 866-673-0445

Xylem |'zīləm|

- 1) The tissue in plants that brings water upward from the roots;
- 2) a leading global water technology company.

We're a global team unified in a common purpose: creating advanced technology solutions to the world's water challenges. Developing new technologies that will improve the way water is used, conserved, and re-used in the future is central to our work. Our products and services move, treat, analyze, monitor and return water to the environment, in public utility, industrial, residential and commercial building services settings. Xylem also provides a leading portfolio of smart metering, network technologies and advanced analytics solutions for water, electric and gas utilities. In more than 150 countries, we have strong, long-standing relationships with customers who know us for our powerful combination of leading product brands and applications expertise with a strong focus on developing comprehensive, sustainable solutions.

**For more information on how Xylem can help you,
go to www.xylem.com**



**Xylem Inc.
www.xylem.com/goulds**

Goulds is a registered trademark of Goulds Pumps, Inc. and is used under license. CentriPro is a trademark of Xylem Inc. or one of its subsidiaries.

© 2021 Xylem Inc. GSSERVICE R7 August 2021