

LEH155M2-3 (B67)

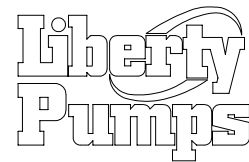
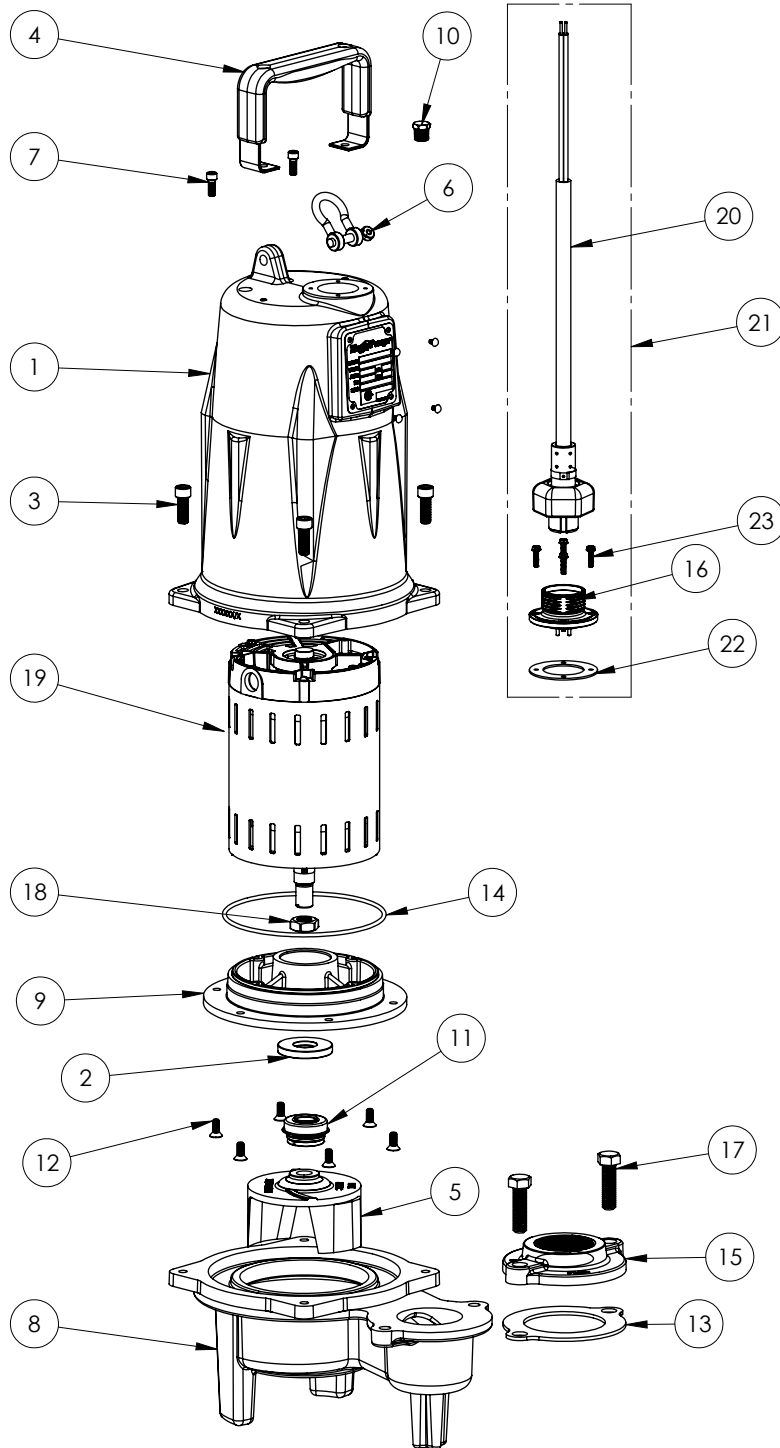

**LEH155M2-3****LEH155M2-3 (B67)**

#	PART #	DESCRIPTION	QTY	Note
1	5850000	MOTOR COVER	1	
2	5618000	DOUBLE LIP SEAL	1	
3	5862000	BOLT, 3/8-16X1 SHCS SS	4	
4	5613000	HANDLE	1	
5	K001323	IMPELLER, CAST IRON, INCLUDES 5887000	1	
6	5611000	SHACKLE	1	
7	8103000	SCREW 1/4-20x5/8" HX SKT SS	2	
8	58730AR	LEH150 SERIES VOLUTE	1	
9	5851000	MOTOR PLATE	1	
10	5071000	BRASS OIL PLUG	1	
11	5633000	3/4" UNITIZED SHAFT SEAL	1	[1]
12	8018000	1/4-20 x 5/8 SLOTTED FLAT HEAD BOLT	6	
13	5129000	FLANGE GASKET, FITS 2" OR 3"	1	
14	5617000	O-RING	1	
15	K001221	2" DISCHARGE KIT	1	
16	5629000	CORDPLATE	1	
17	8037000	1/2-13 x 1-3/4 STAINLESS STEEL BOLT	2	
18	5887000	NUT, JAM, 5/8-18 HEX S.S.	1	
19	5885000	MOTOR 2HP 575V 3PH LEH (KIT, MTR REPLACE K001861)	1	[1]
20	K001383	56310C0 35' CORD KIT	1	
21	K001424	3PH POWER CORD ASSY KIT 35FT	1	
23	8064000	#8-32 x 5/8 HEX WASHER HEAD SCREW	4	
22	5060000	CORD PLATE GASKET	1	

**PART NOTES:**

[1] - Part requires factory authorized service. Contact Liberty Pumps at 1-800-543-2550