

e-SH

316 STAINLESS STEEL END SUCTION CENTRIFUGAL PUMPS
EQUIPPED WITH NEMA PREMIUM EFFICIENT MOTORS

CONTENTS

General Introduction	3
Applications and Benefits	4
Performance Coverage at 60 Hz, 2-poles and 4-poles.....	5
Product Numbering Systems	6
Performance Curves at 60 Hz, 2-poles.....	7
Performance Curves at 60 Hz, 4-poles.....	21
Standard Impeller Trims	35
Pump Cross-Section and Main Components	36
Materials of Construction	36
Motor Sizing	37
Performance Curves at 50 Hz, 2-poles.....	39
Close Coupled S-Group Dimensions and Weights	53
Close Coupled M-Group Dimensions and Weights	54
Frame Mounted S-Group Dimensions and Weights.....	55
S-Group Engineering Data	56
Frame Mounted M-Group Dimensions and Weights	57
M-Group Engineering Data	58
Nameplate	59
Technical Appendix.....	60

GENERAL INTRODUCTION

The new and improved Goulds Water Technology e-SH Series is a high performance stainless steel centrifugal end-suction pump. The e-SH is fully made in AISI 316 stainless steel which makes it suitable for handling water as well as non-aggressive or moderately aggressive fluids. The pumps are equipped with interchangeable John Crane Type 21 mechanical seals, NEMA motors in single and three phase, and have a back pull-out design (impeller, bracket and motor can be extracted without disconnecting the pump body from the piping). The e-SH series pumps are available in the following configurations:

- **Close-coupled:** compact design that saves space and simplifies maintenance.
- **Frame mounted:** flexible-coupled with cast iron power frame (grease lubricated ball bearing assembly).
- **Bare shaft pump:** bare pump suitable to be coupled with a standard electric motor.

Pumps assembled at the factory are certified to the NSF/ANSI 61 Drinking Water System Components Standard.

HYDRAULIC SPECIFICATIONS

- **Maximum flow:** up to **1140 gpm**
- **Maximum head:** up to **464 ft TDH**
- Hydraulic performance compliant with **ANSI/HI 14.6 Grade 2B**
- **Maximum temperature:** up to 250 °F
- **Maximum working pressure:** 230 psi
- **Suction and Discharge Flanges:** mate with ANSI class 150 flanges.
- **Enclosed impeller and replaceable wear ring:** for high efficiency and maximum wear life.
- Connection dimensions according to EN 733 (except for ESH 25 models)

MOTOR SPECIFICATIONS

Close Coupled

- NEMA standard JM shaft open drip-proof, totally enclosed and explosion-proof enclosures, 60 Hz, 1750 or 3500 RPM.
- Single phase ODP (115/230V) 1750 RPM, 1-5 HP.
- Three phase ODP, TEFC, Explosion proof (208-230/460V).
3500 RPM, 2-100 HP
1750 RPM, 1-25 HP

Overload protection must be provided. Contactor with overload for single phase or starter with heaters for three phase ordered separately.

Frame Mounted

- NEMA standard T-frame open drip-proof, totally enclosed and explosion-proof (three phase only) enclosures, 60Hz, 1750 or 3500 RPM.
- Single phase (115/230V) 1750 RPM, 1-5 HP
- Three phase (208-230/460V)
3500 RPM, 3-125 HP
1750 RPM, 1-25 HP

Overload protection must be provided. Contactor with overload for single phase or starter with heaters for three phase ordered separately.

Optional: Rigid carbon steel bedplate, sheet metal coupling guard designed to OSHA specifications and T.B. Woods type "SC" spacer couplings.

APPLICATIONS

The **e-SH** is suitable for a wide range of non-aggressive to mildly aggressive fluids in commercial building, industrial & diverse OEM applications.

- Water intake
- Water transfer and circulation
- Pressure boosting
- Process cooling and heating
- Fluid transfer and transport
- Produced water transfer and boosting
- Boiler feed booster

PUMPED FLUIDS

- Groundwater
- Potable water
- Process water
- Gray/used water
- Heat transfer fluids
- Produced water

BENEFITS

The GWT model e-SH provides the following benefits:

Reliability: the high quality production, the robust construction and operation, the easily interchangeable mechanical seals, and wear rings guarantee a continuous operation without faults and a shorter down time for maintenance.

Total cost of ownership: the best hydraulic and electric efficiency and the easy and quick maintenance reduce the operation and maintenance costs and save energy.

Expert support: Since the proper selection and configuration of the e-SH pump is critical to long-term efficiency and dependability, give us a call. We are continuously working with our customers to help them in selecting the right pump for their specific application. Intellitronic X, our user-friendly online selection tool is also available to help you configure your pump. We'll assemble your pump and get it on its way. Intellitronic X is available at www.gouldsintellitronic.com.

PERFORMANCE COVERAGE AT 60 HZ, 2-POLES AND 4-POLES

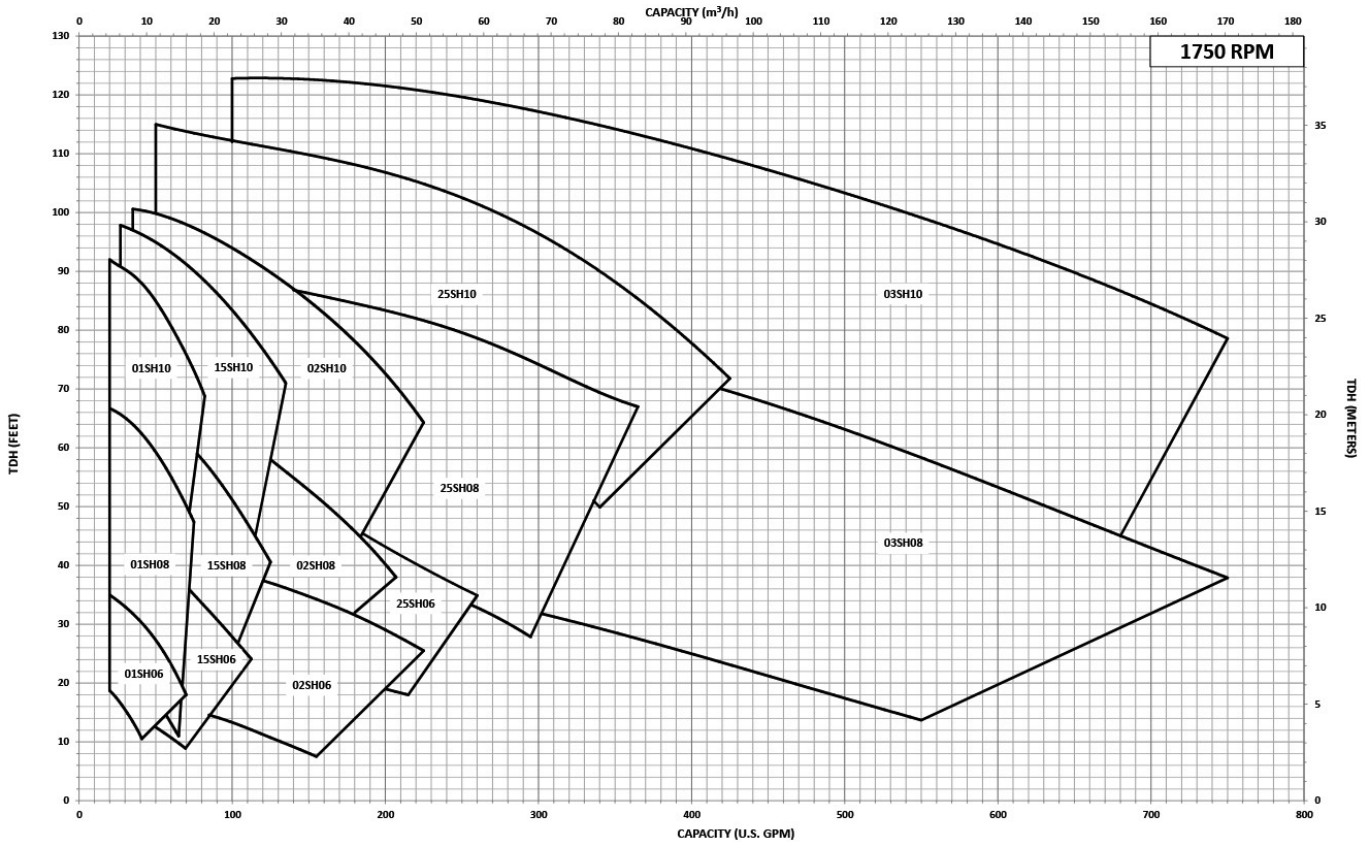
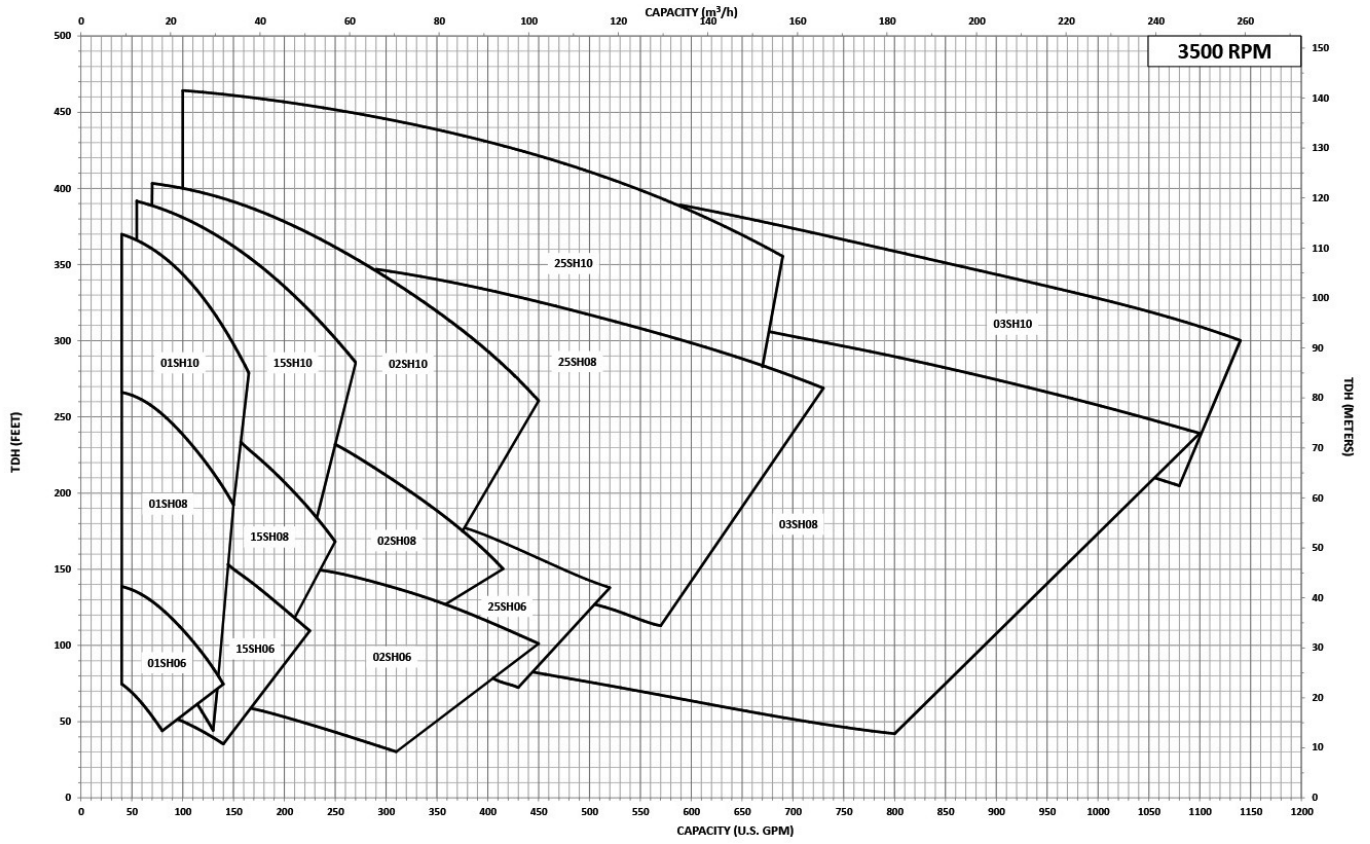

e-SH SERIES PRODUCT NUMBERING SYSTEM

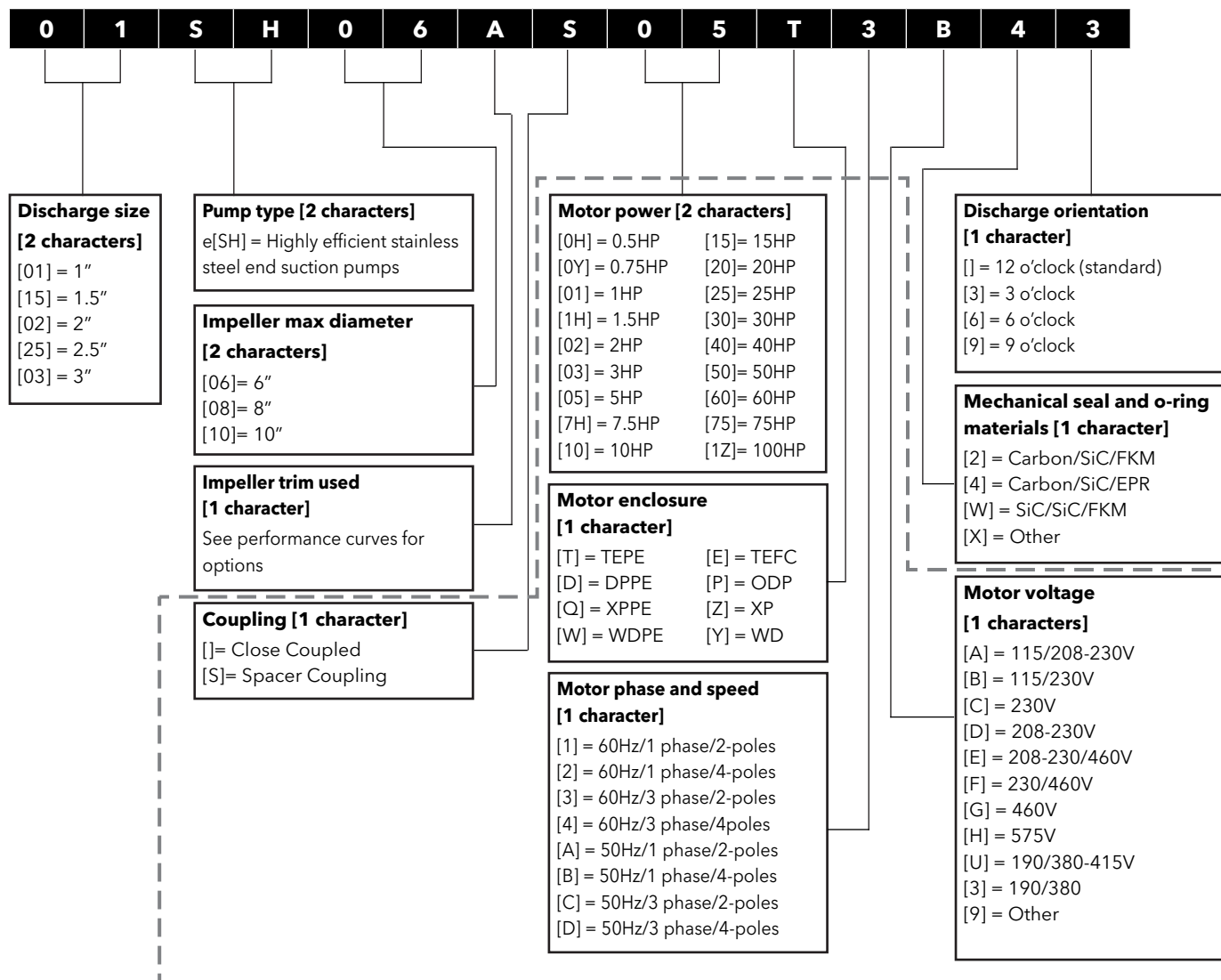

NOTE: For bareshaft pump, replace characters 8-13 by "FRM2" for 7/8" Imp. Bore or "FRM3" for 1 1/4" Imp. Bore
For frame mounted pump, replace characters 9-13 by "FRM2" for 7/8" Imp. Bore or "FRM3" for 1 1/4" Imp. Bore

EXAMPLES

Close Coupled Pump

01SH06A05T3B43

Series e-SH, 1"x2"x6", used with impeller trim "A", 5HP motor, TEPE enclosure, 60 Hz / 3 phase / 2-poles, 115/230V, with mechanical seal C/SiC/EPR, discharge oriented at 3 o'clock.

Bareshaft Pump

01SH06AFRM24

Bare pump, series e-SH, 1"x2"x6", used with impeller trim "A", that will use an S-frame, with mechanical seal C/SiC/EPR.

Frame Mounted Pump with Motor (e-SHF)

01SH06ASFRM243 - "motor catalog number"

Frame mounted pump with motor, series e-SH, 1"x2"x6", used with impeller trim "A", spacer coupling, with mechanical seal C/SiC/EPR, discharge oriented at 3 o'clock

Frame Mounted Pump w/o Motor

01SH06ASFRM24 - "base plate catalog number"

Frame mounted pump, series e-SH, 1"x2"x6", used with impeller trim "A", spacer coupling, with mechanical seal C/SiC/EPR.

PERFORMANCE CURVES AT 60 HZ, 2-POLES

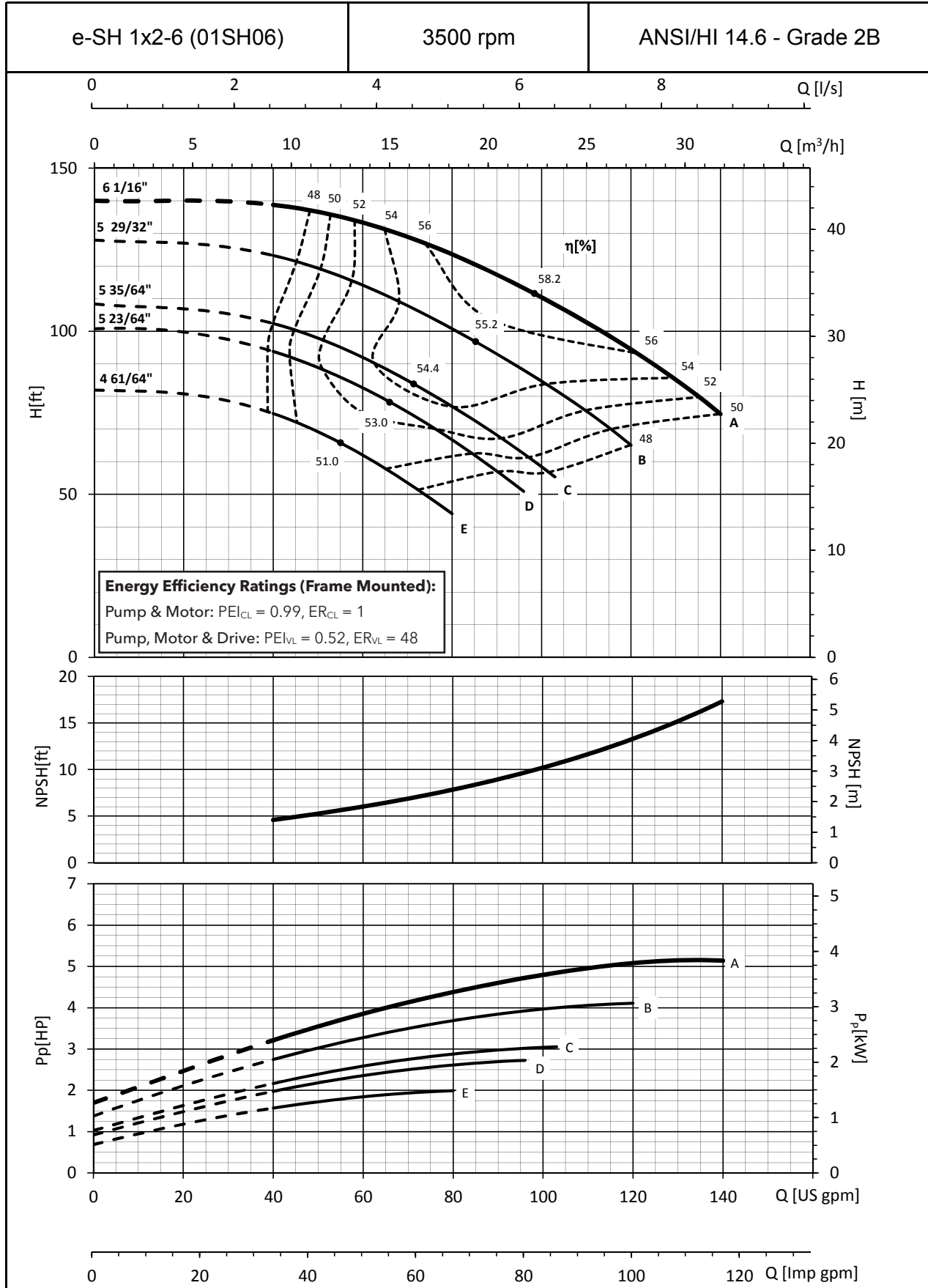

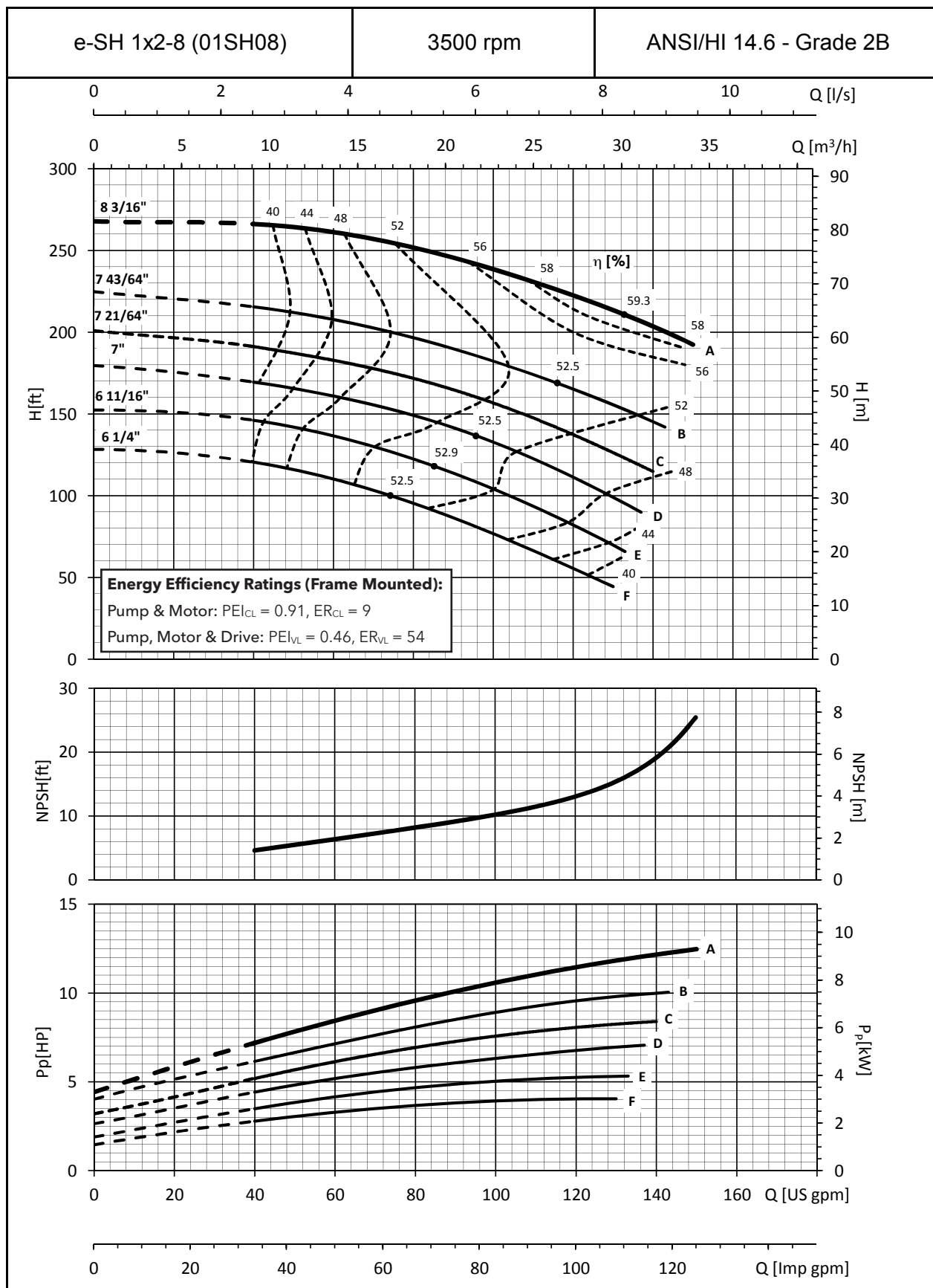

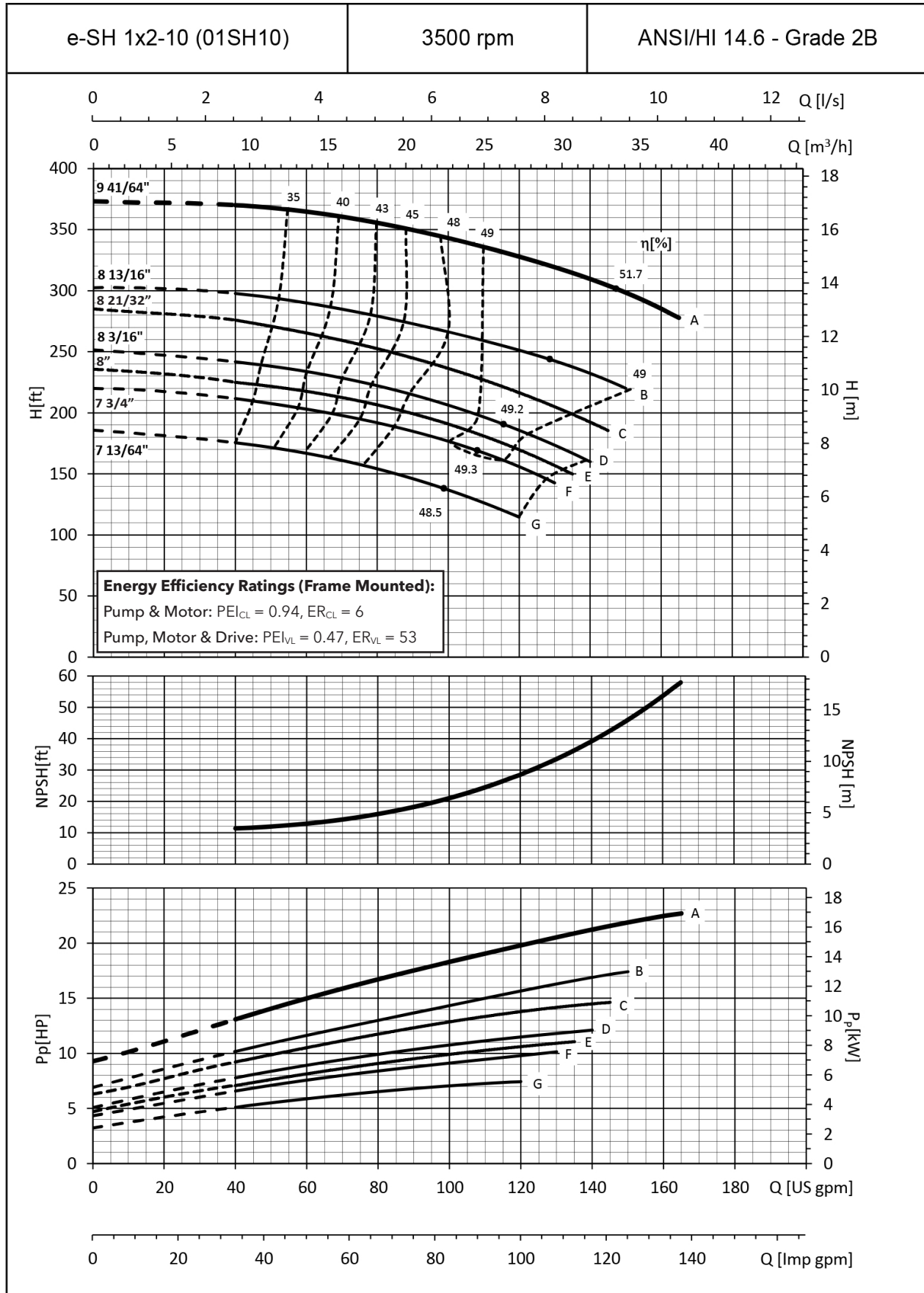

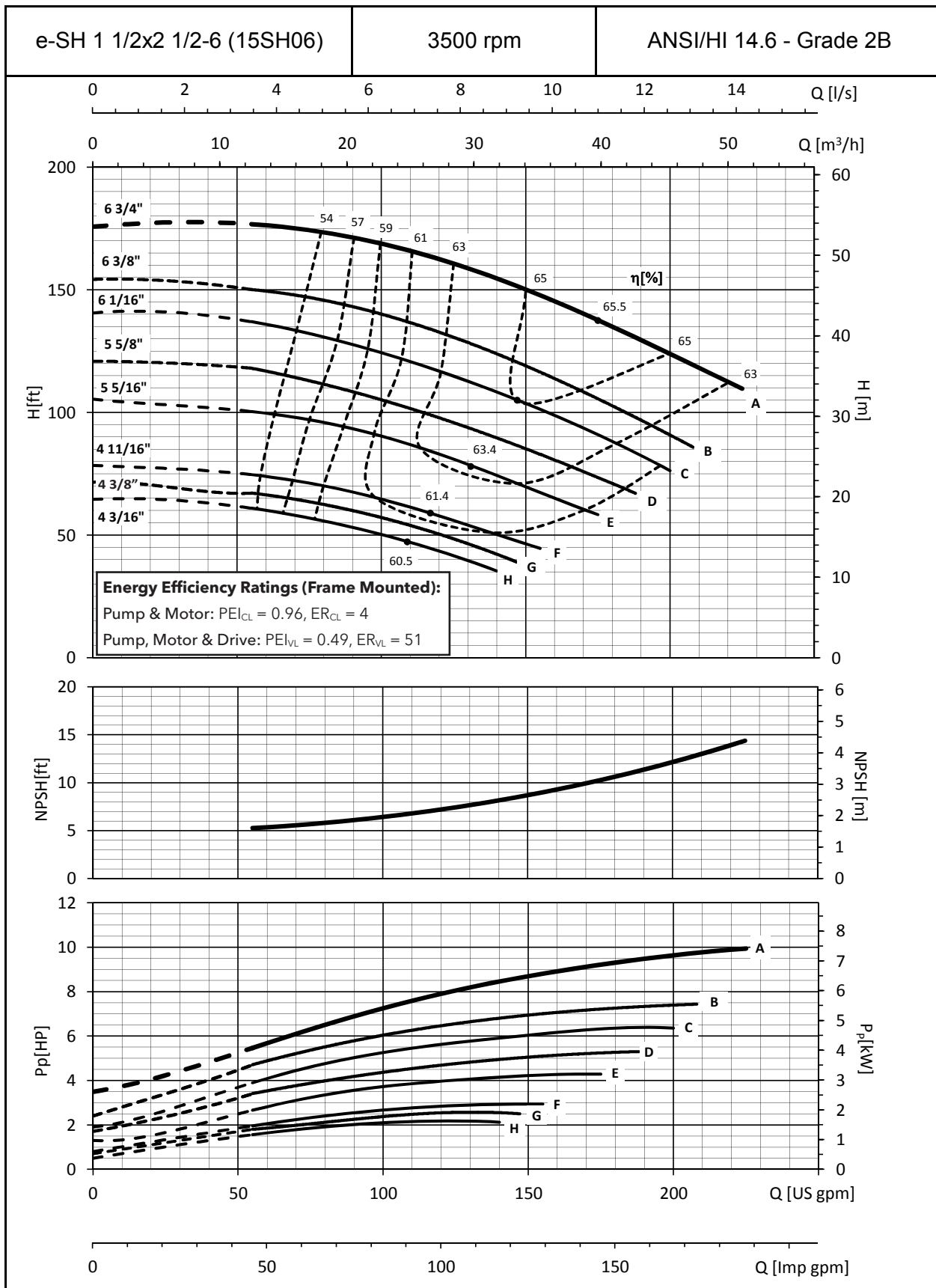

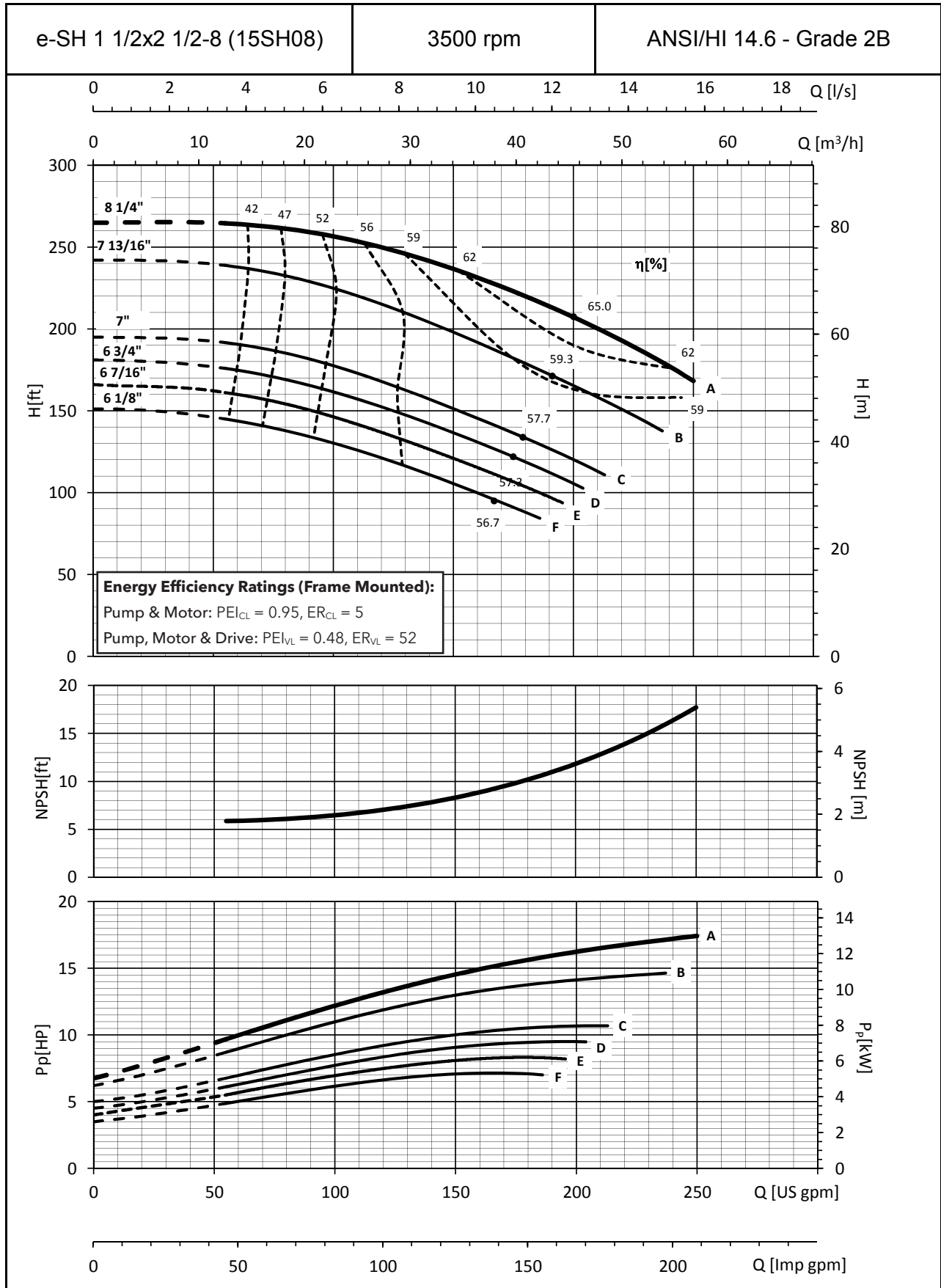

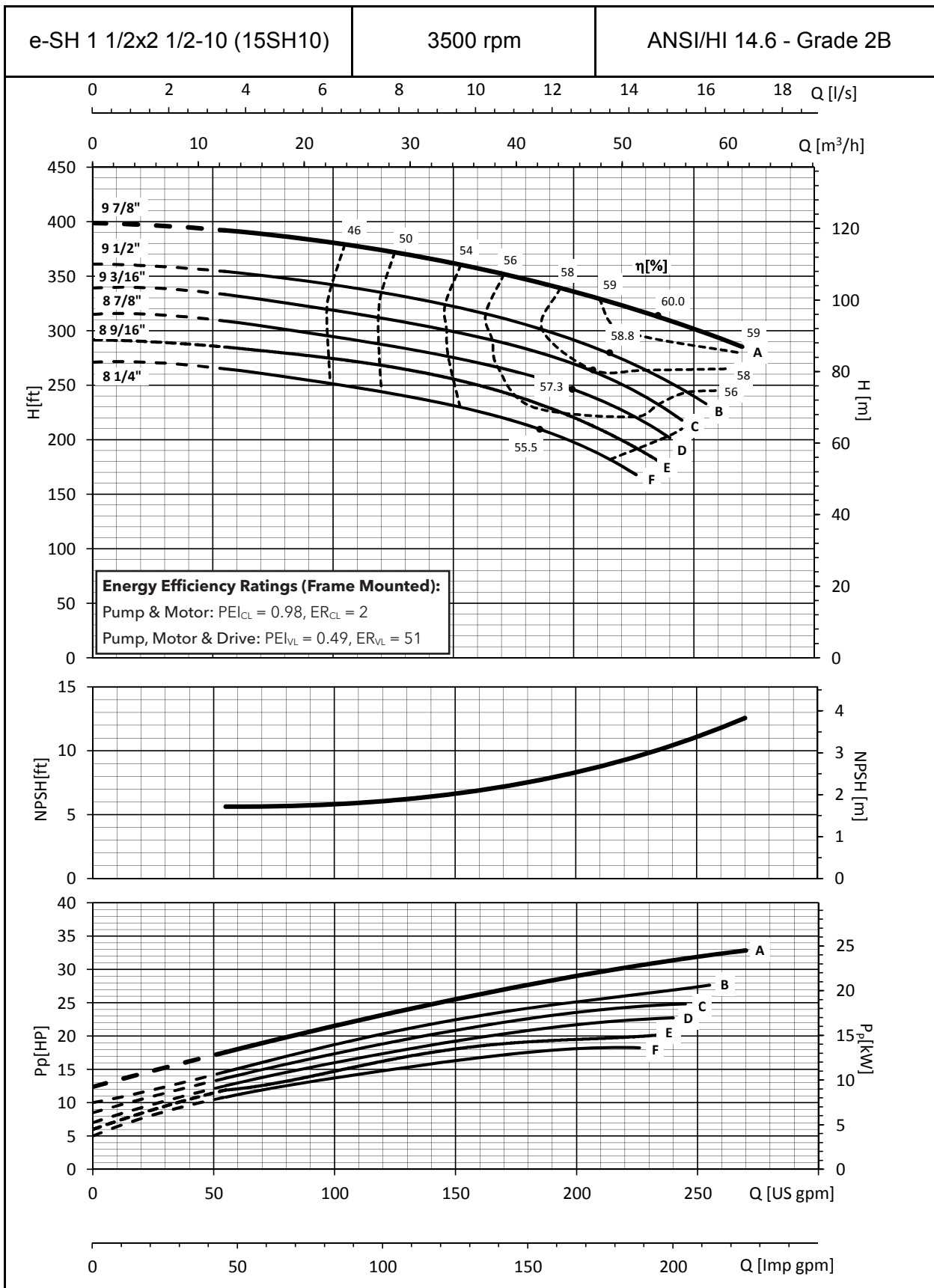

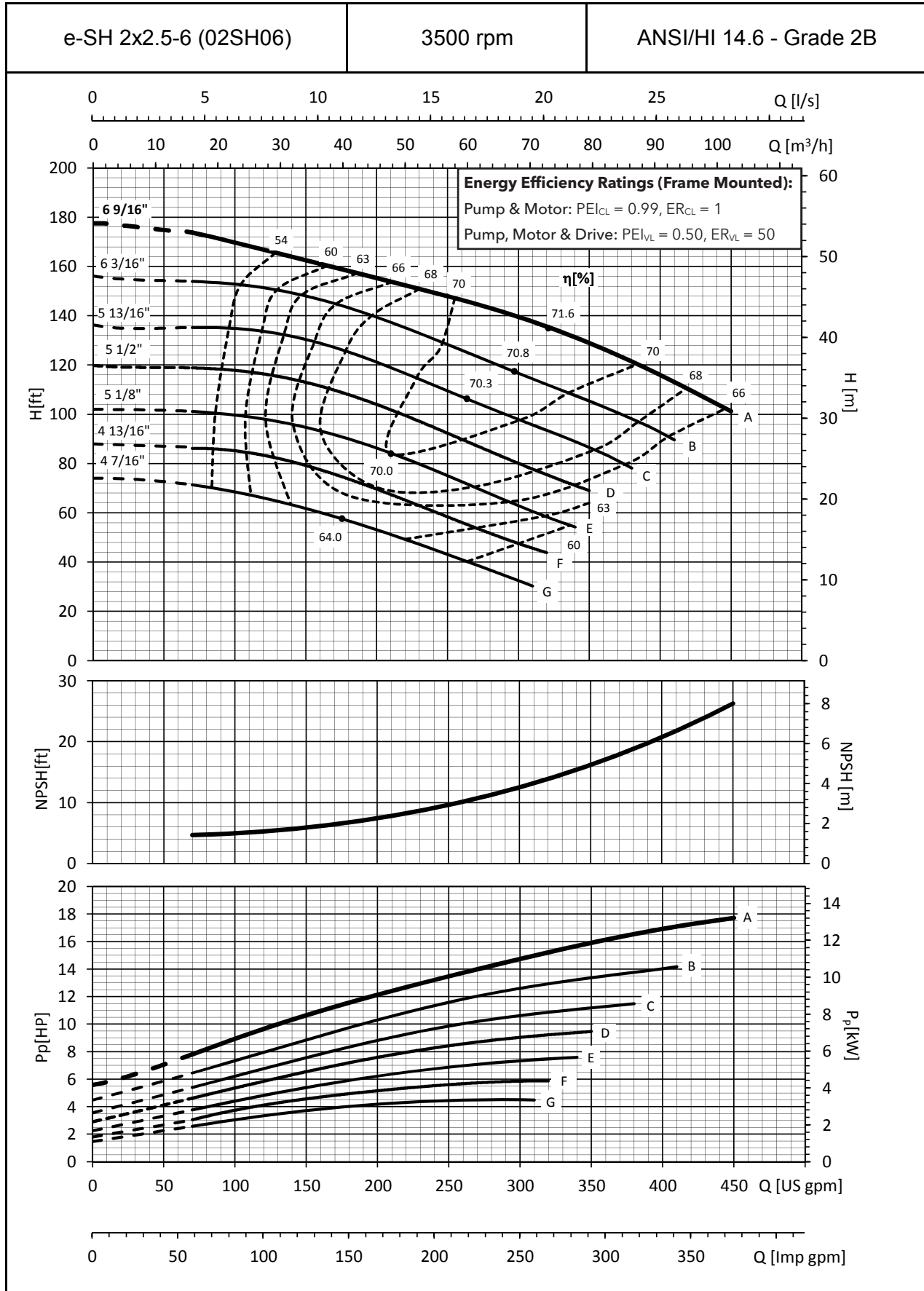

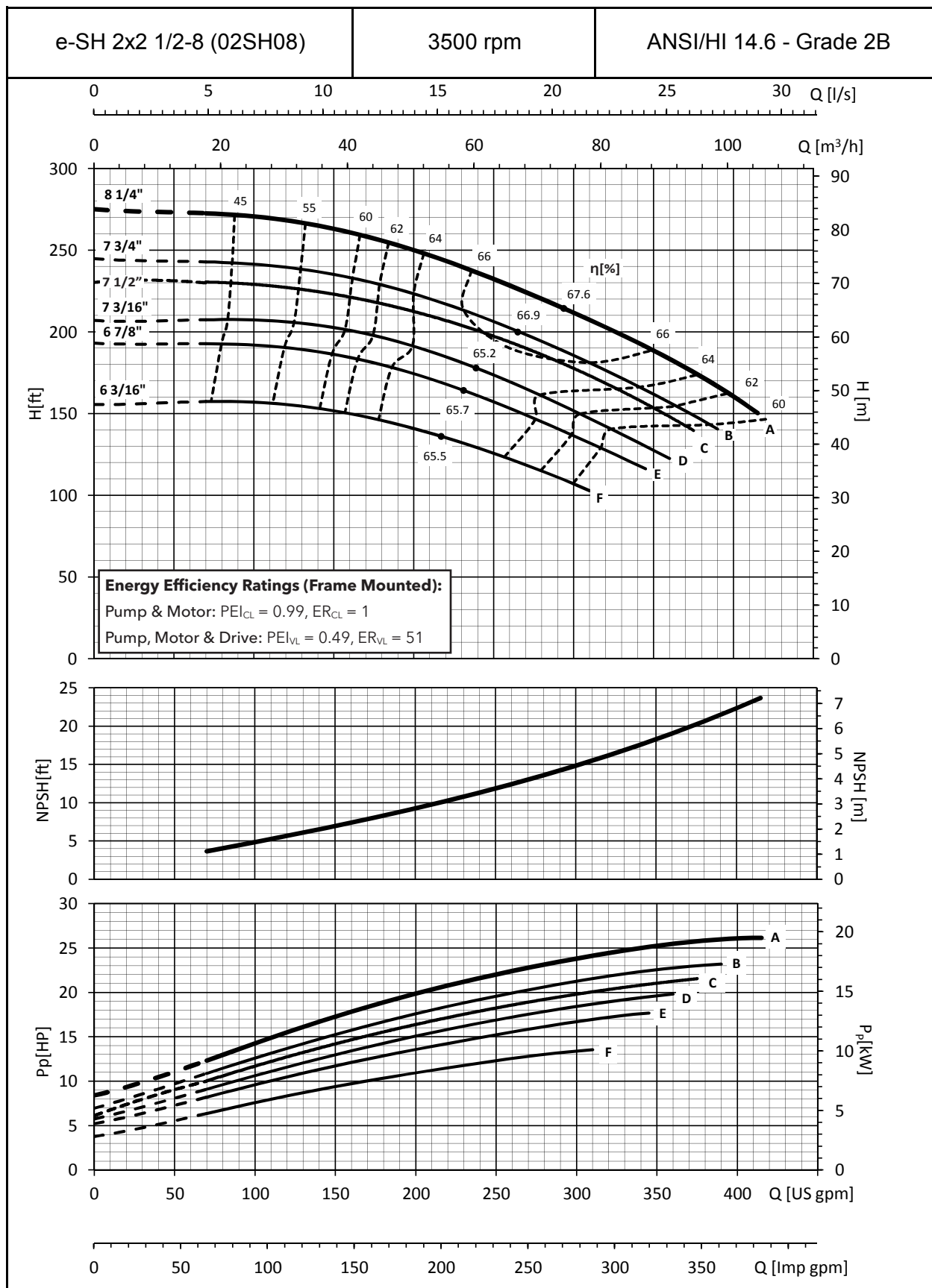

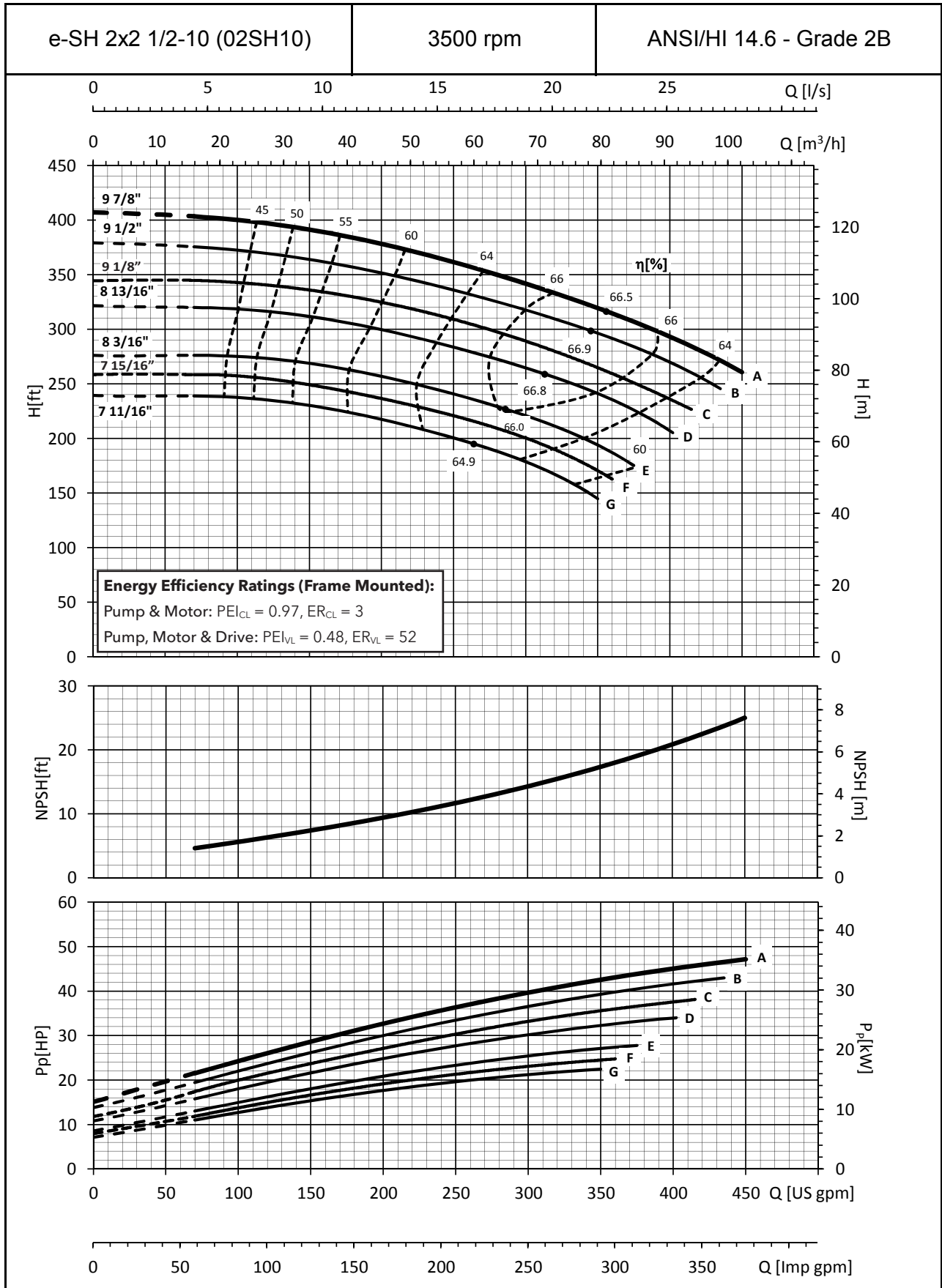

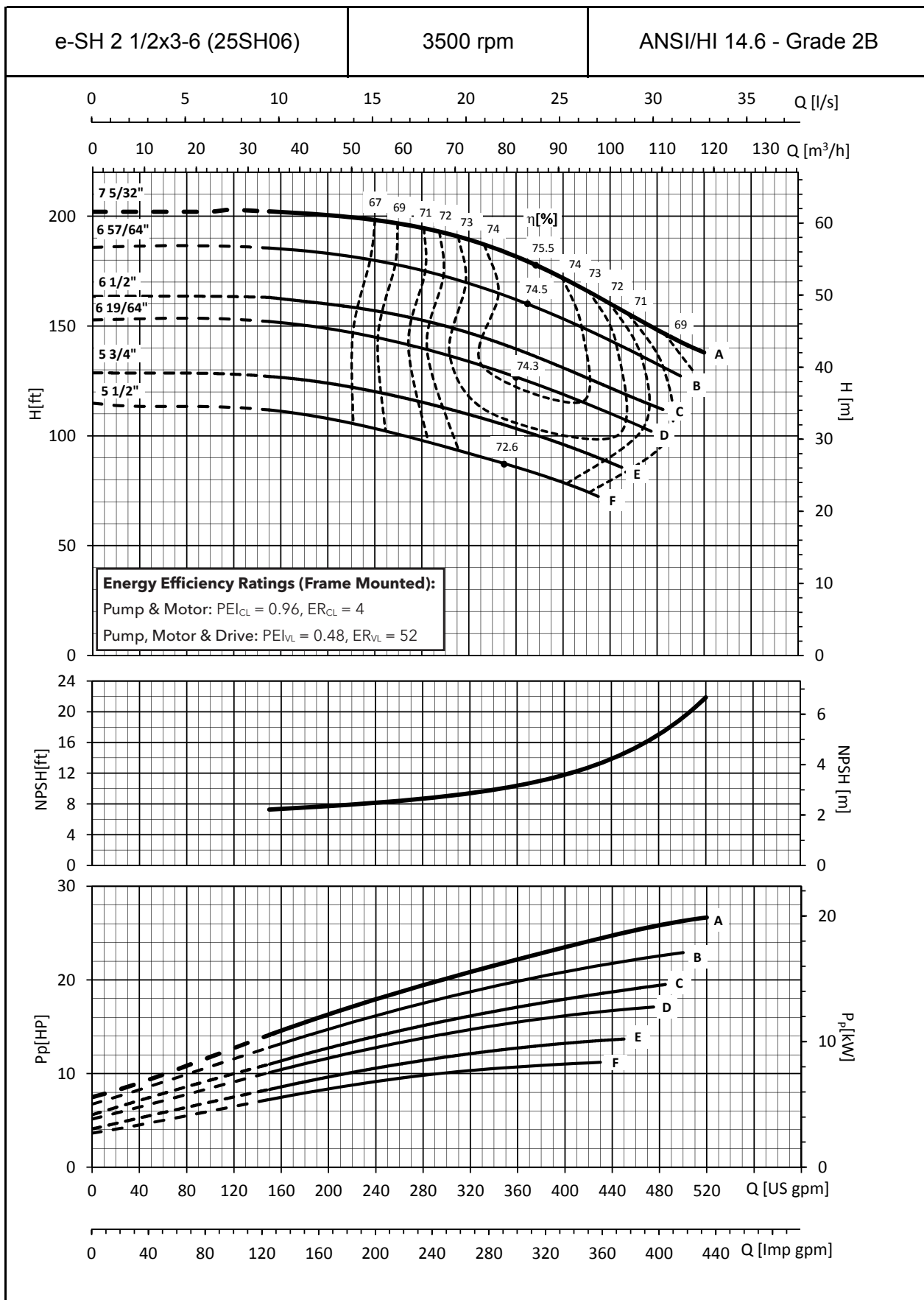

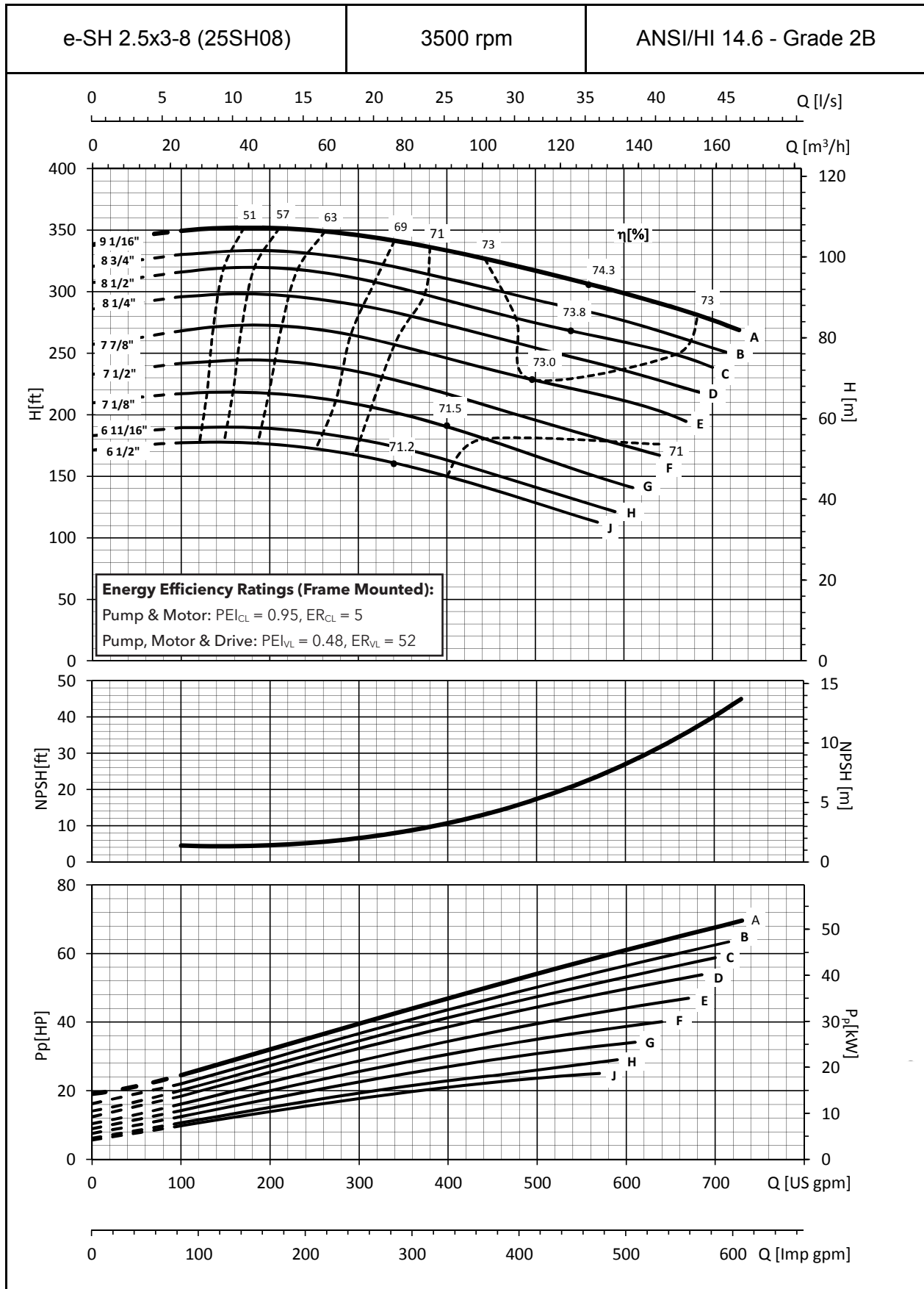

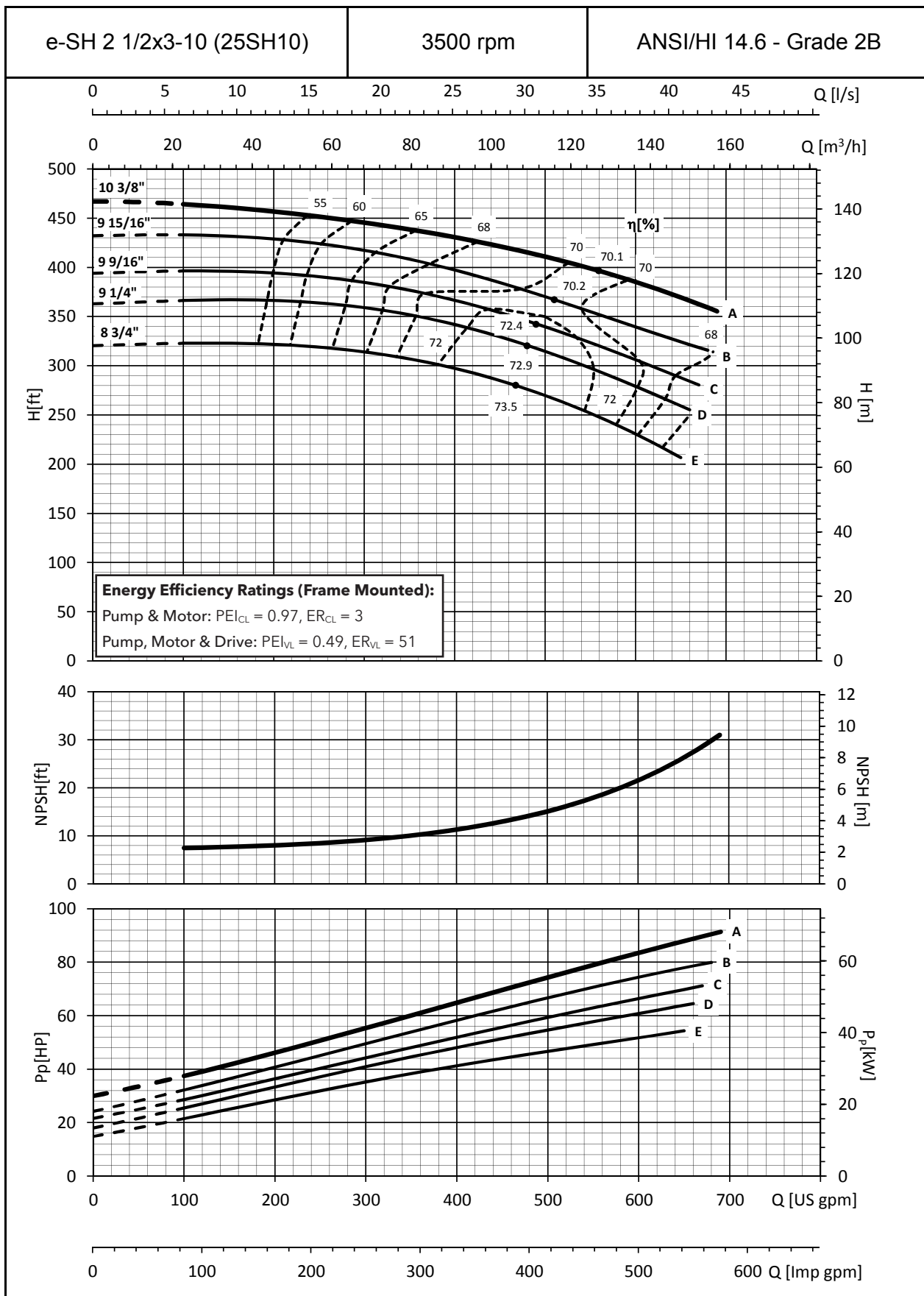

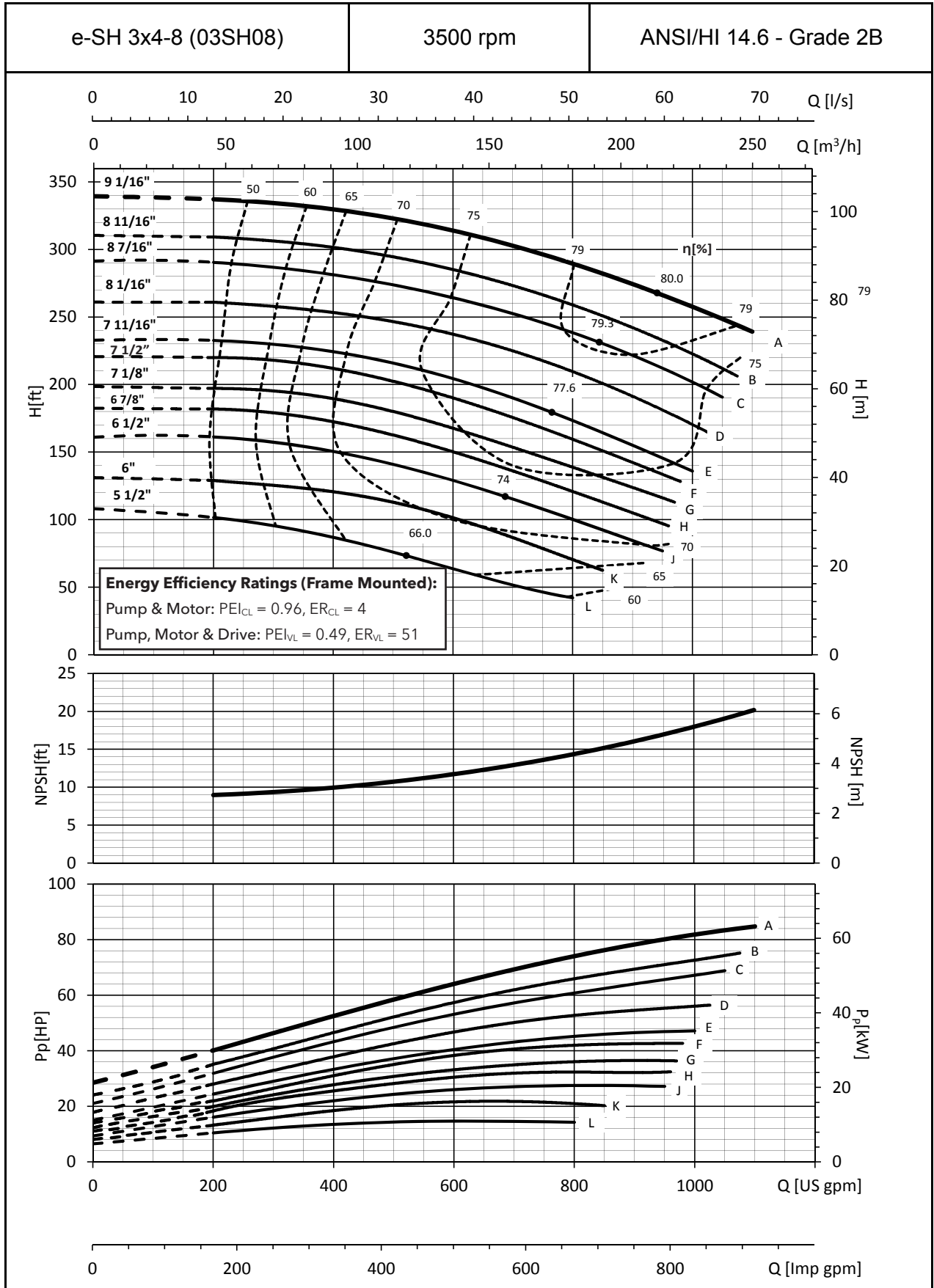

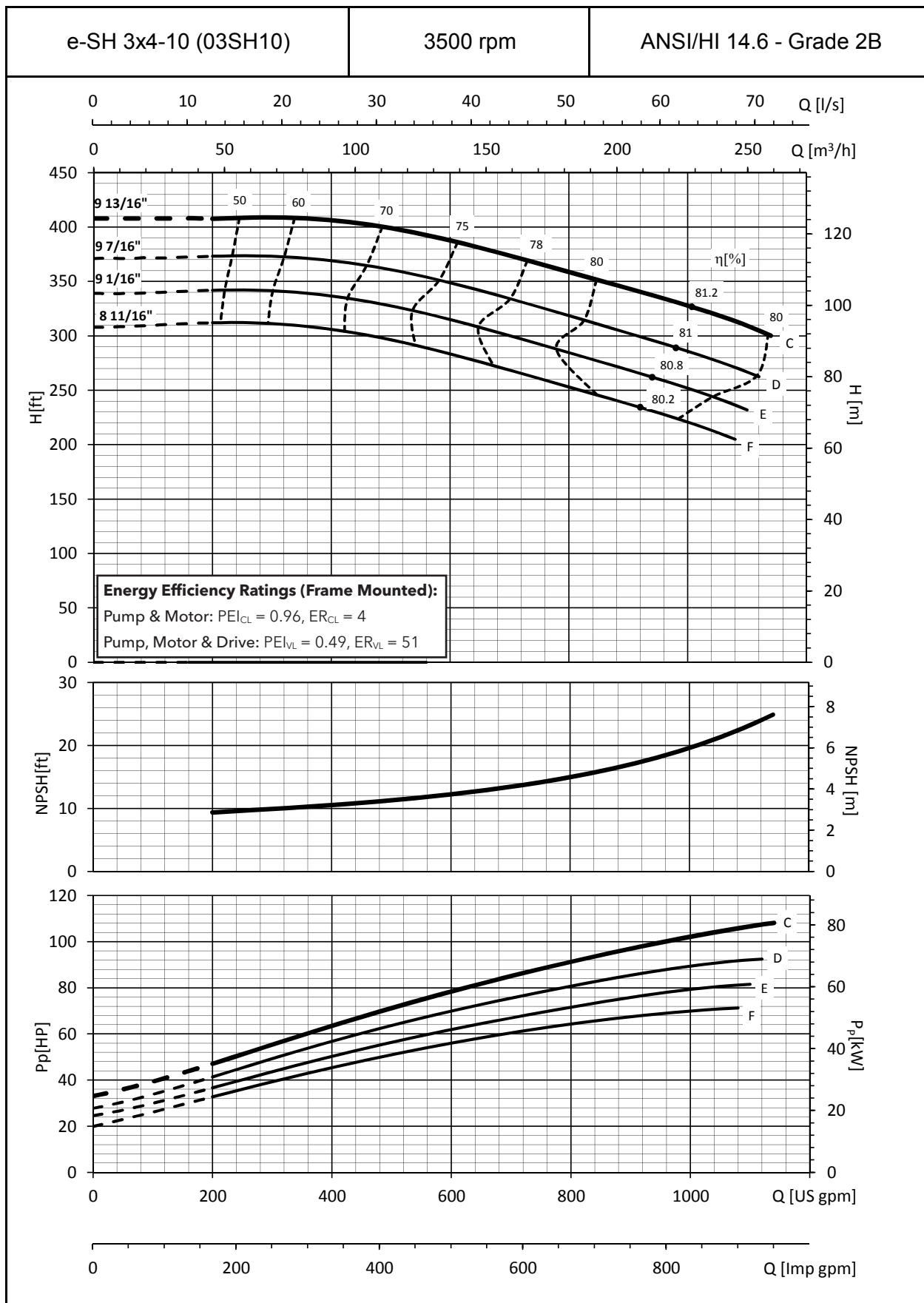

PERFORMANCE CURVES AT 60 HZ, 4-POLES

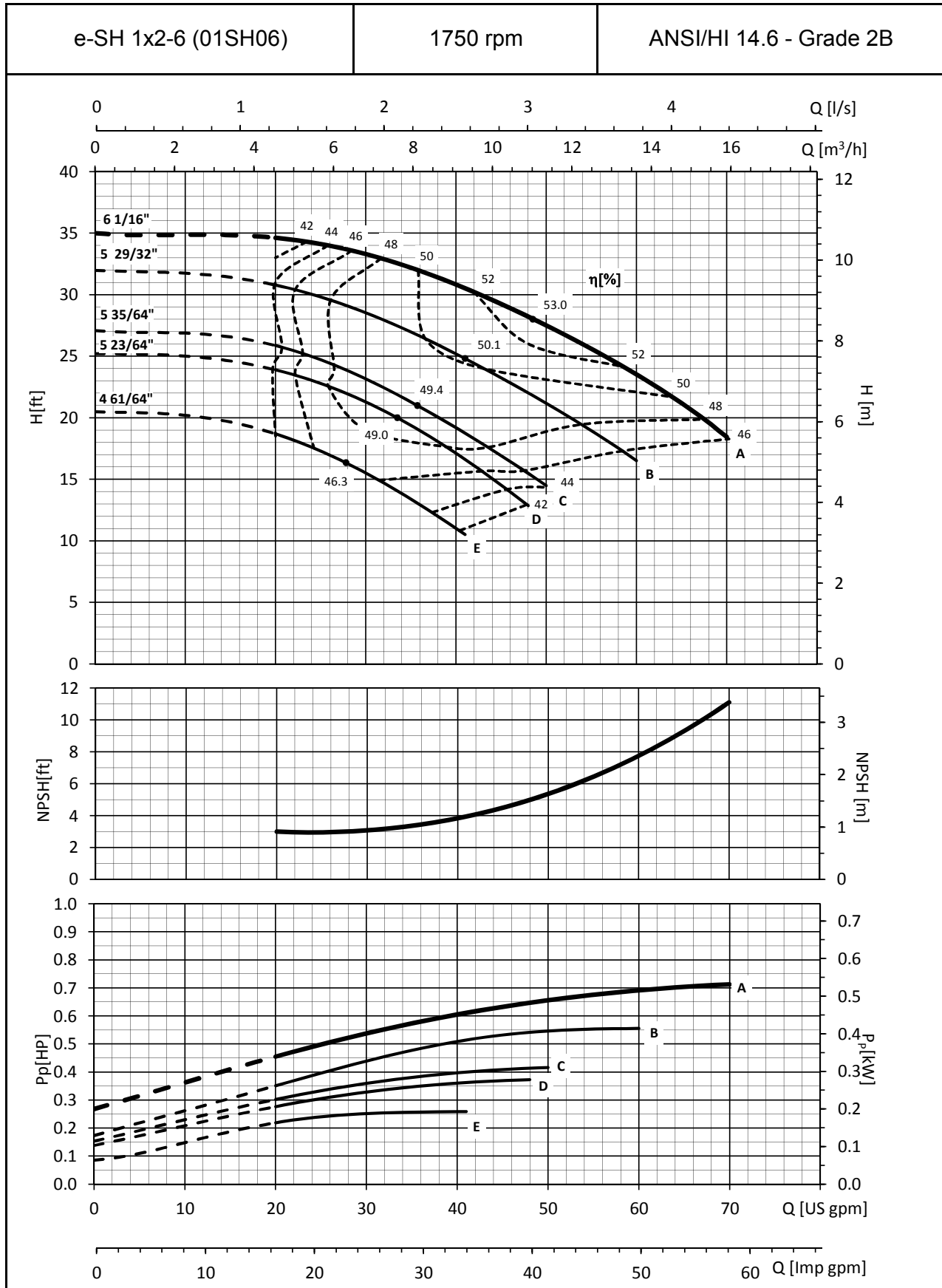

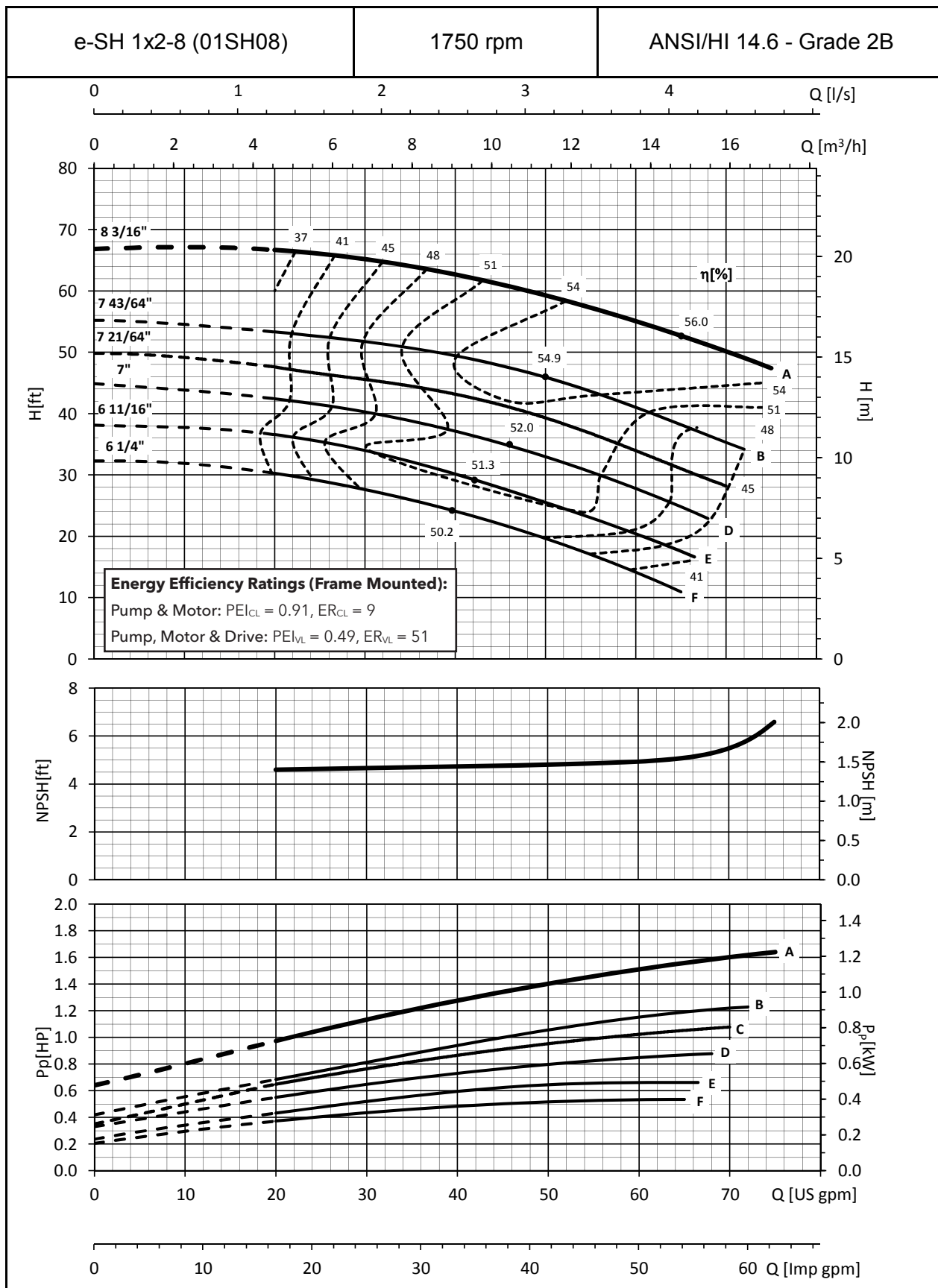

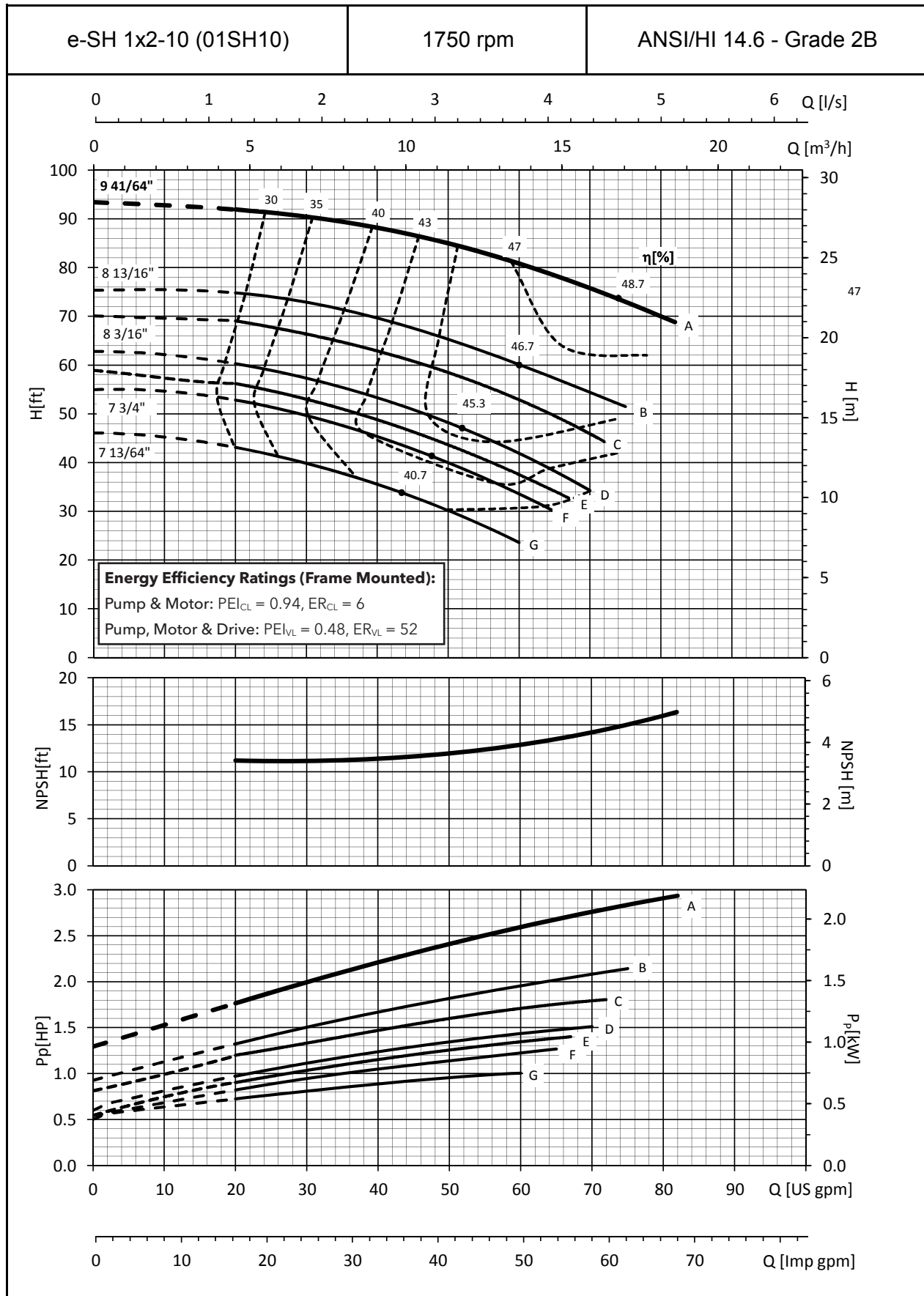

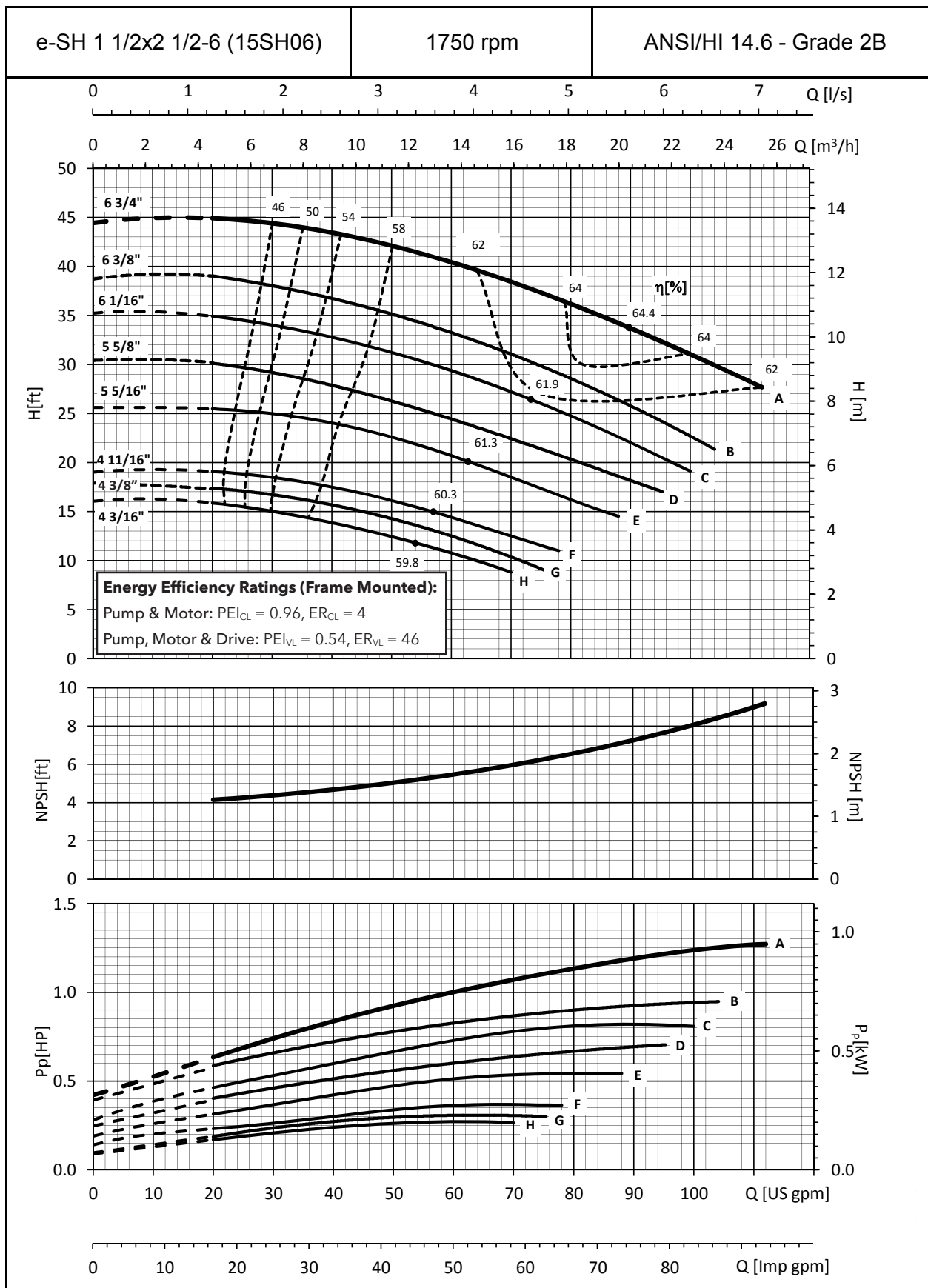

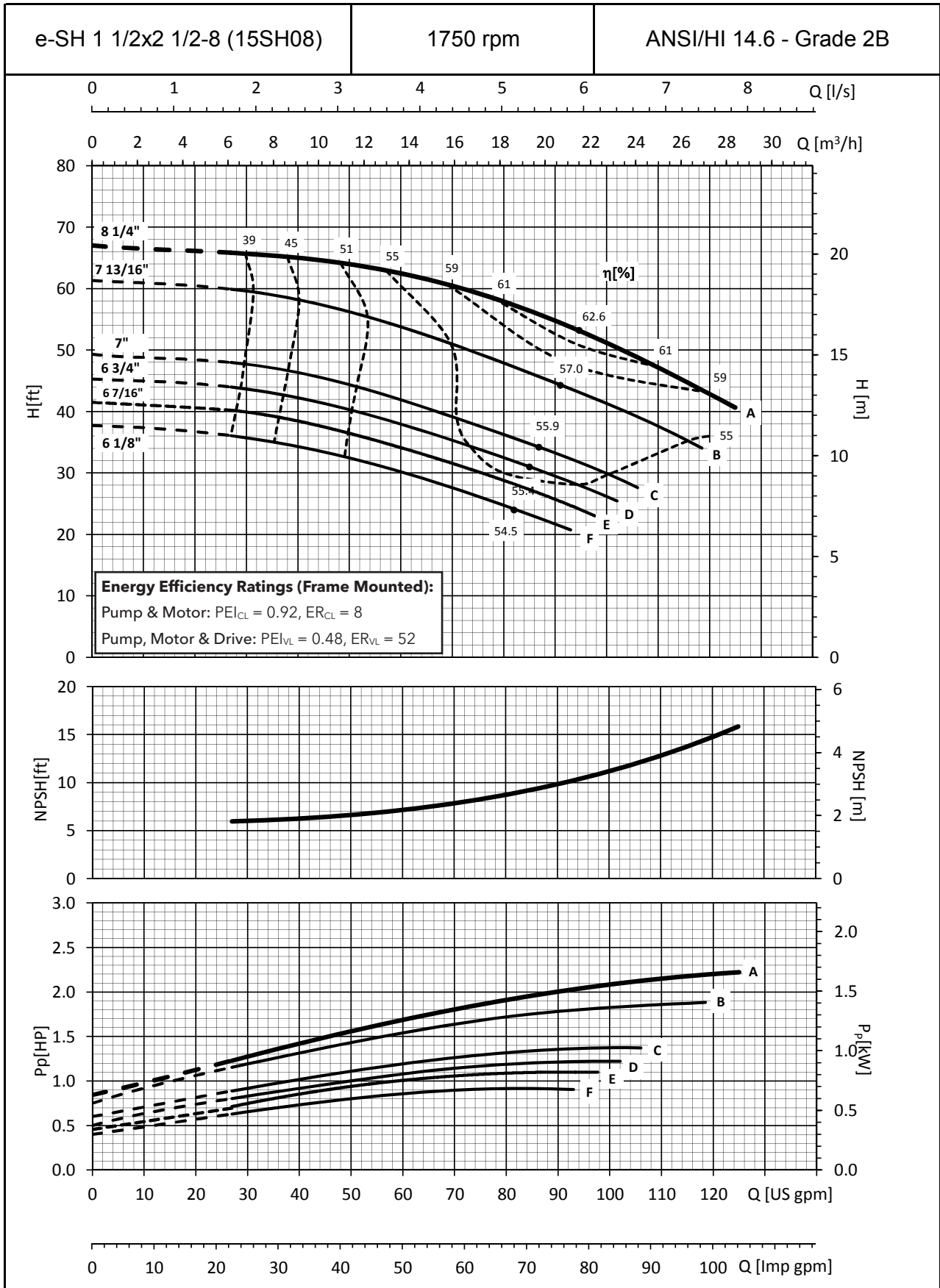

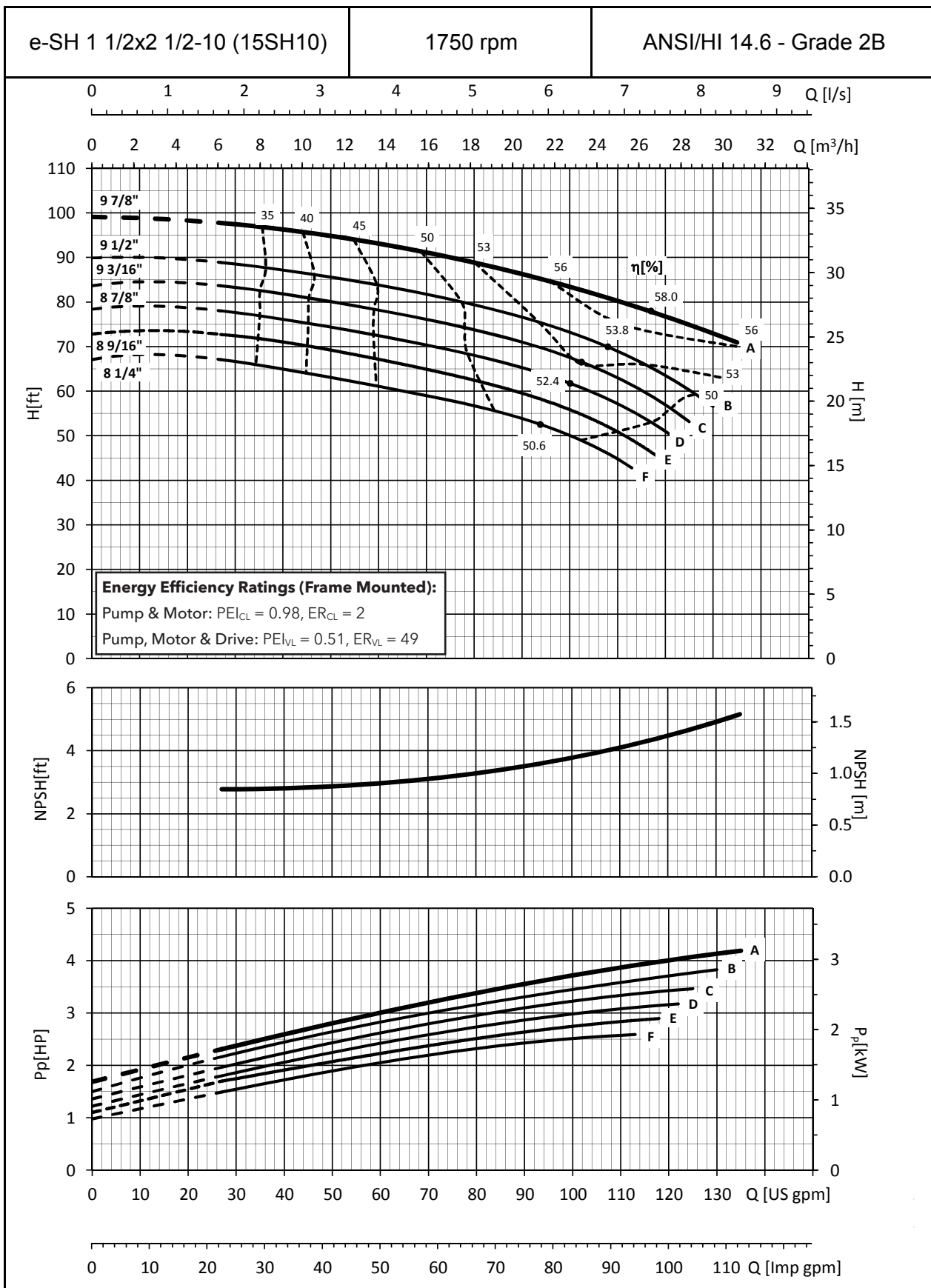

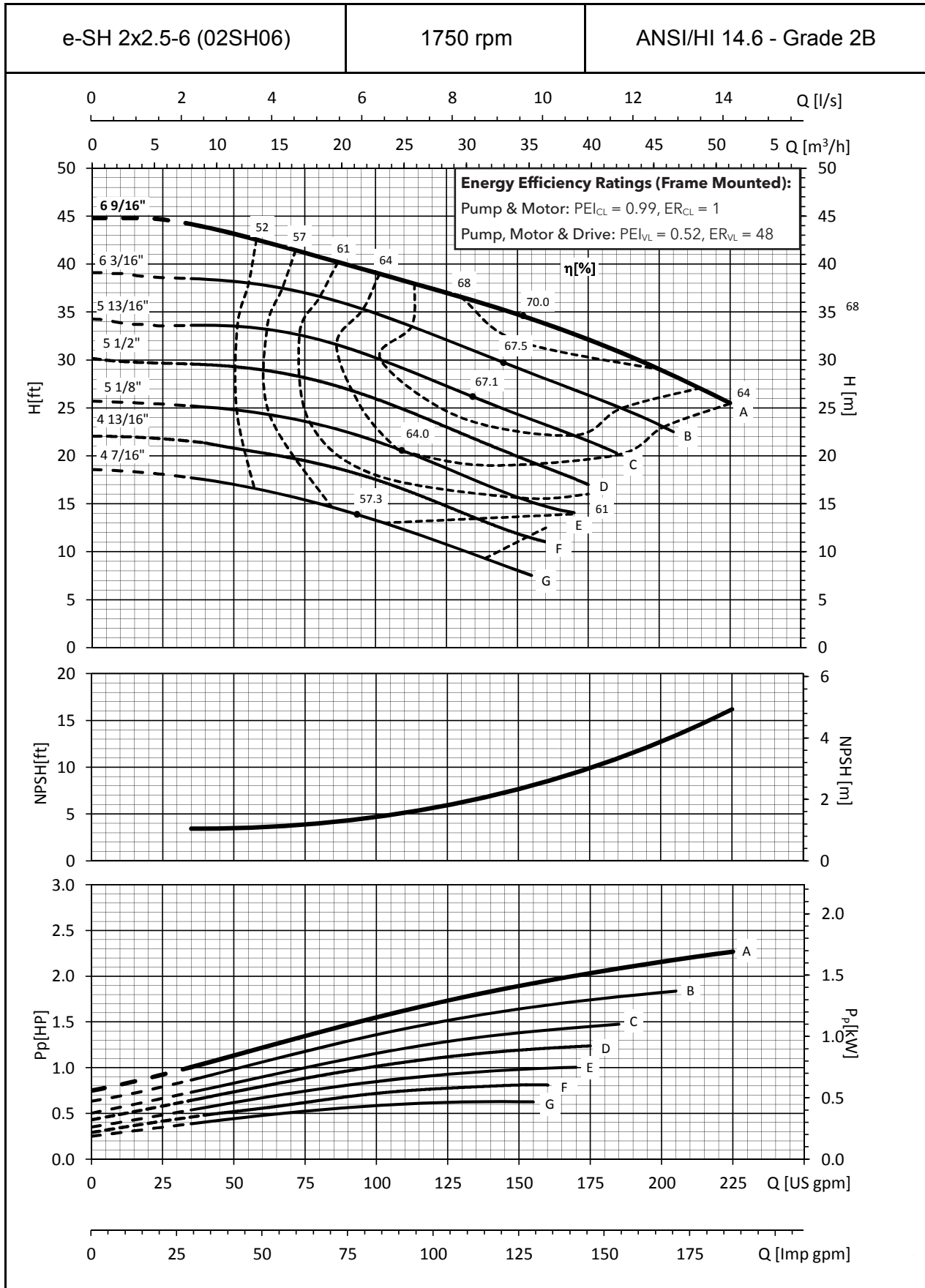

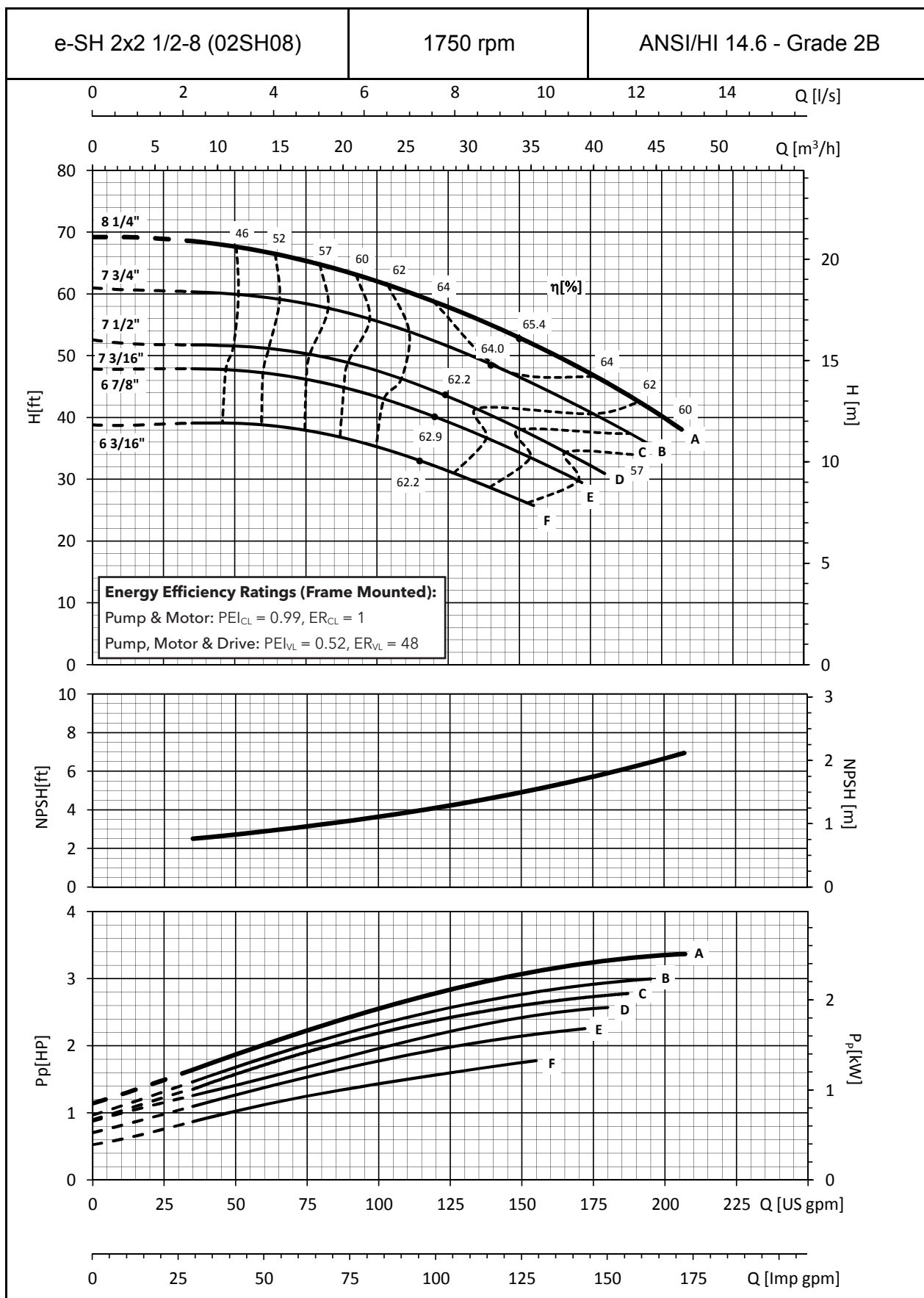

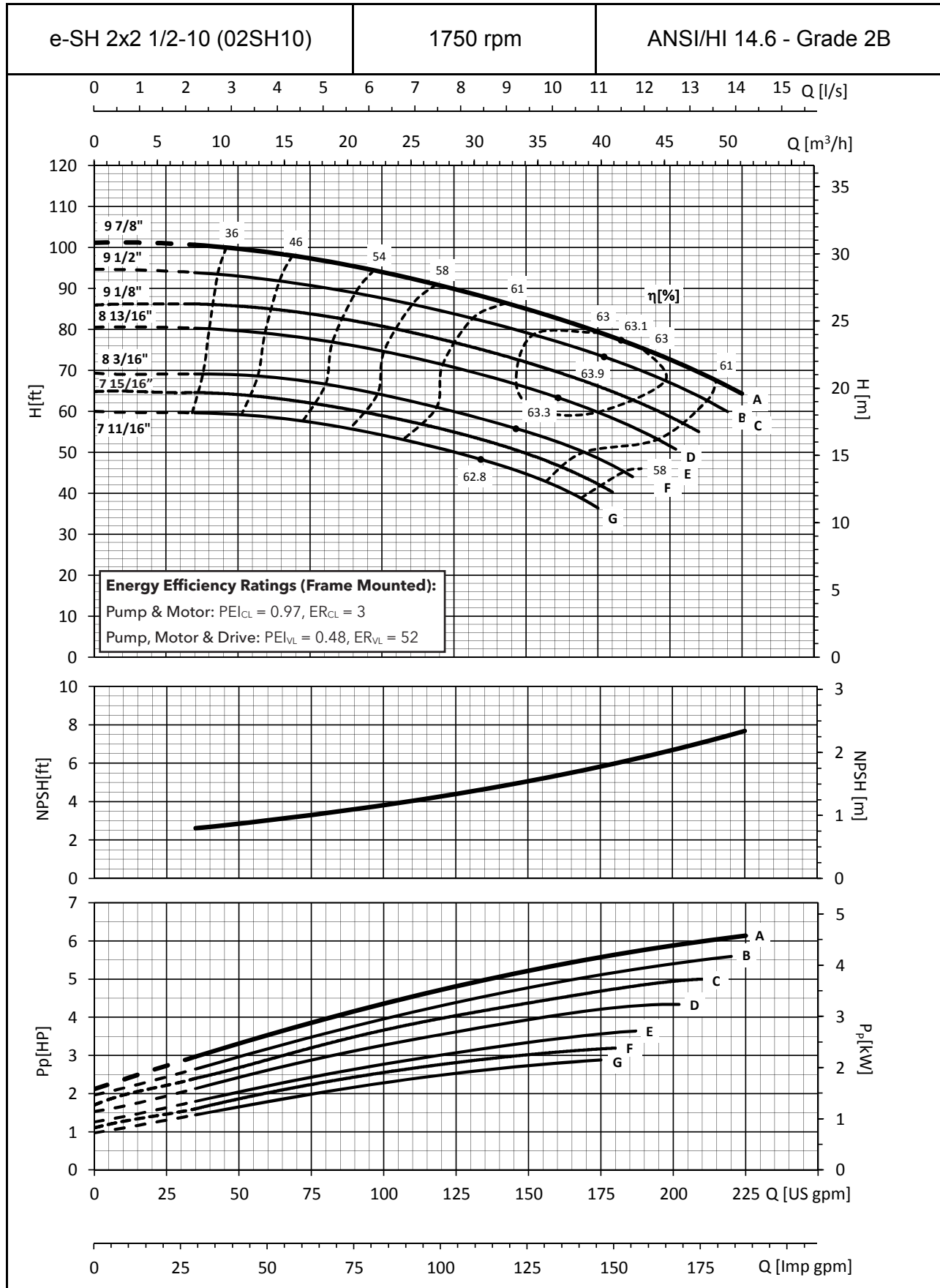

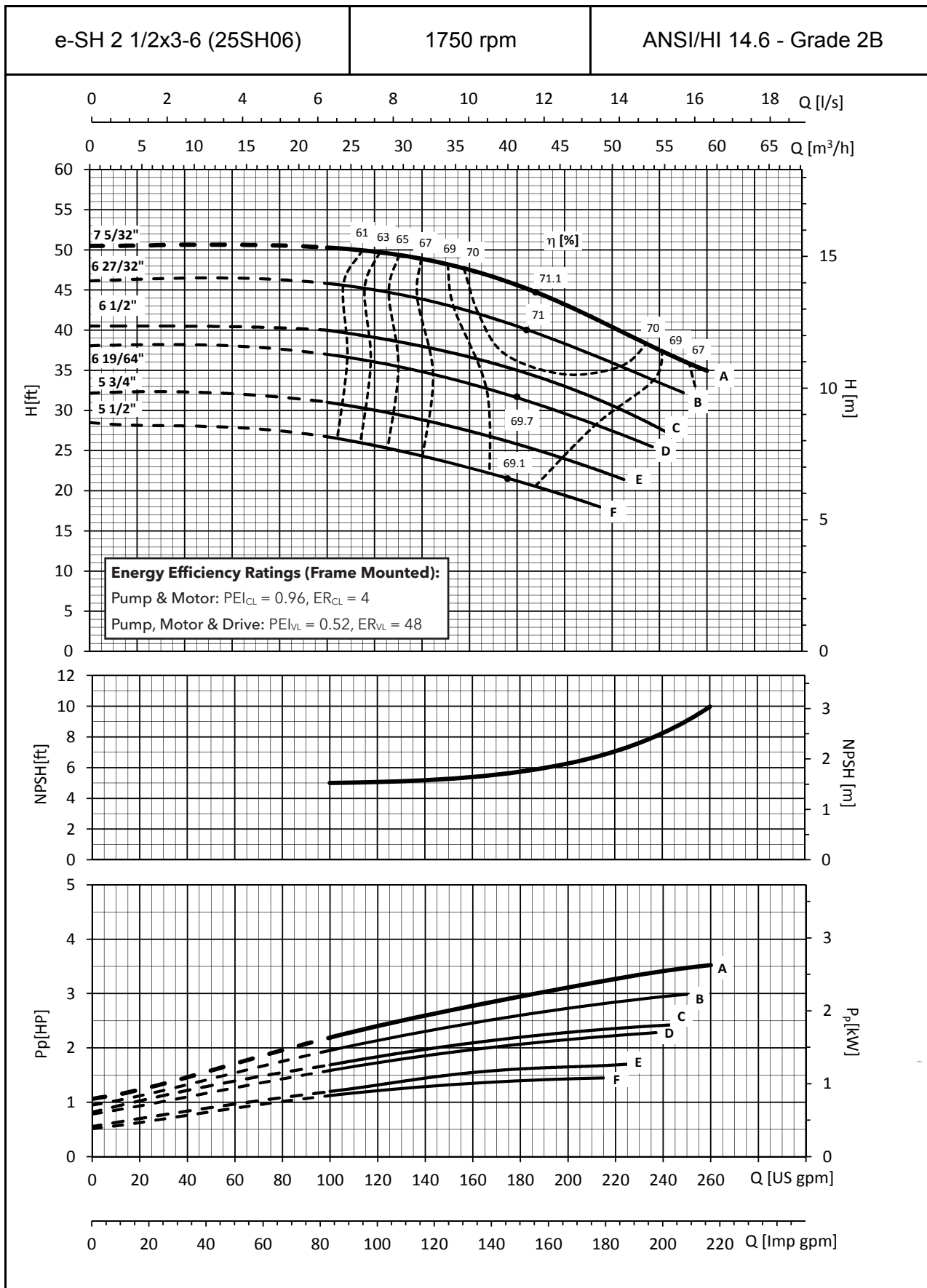

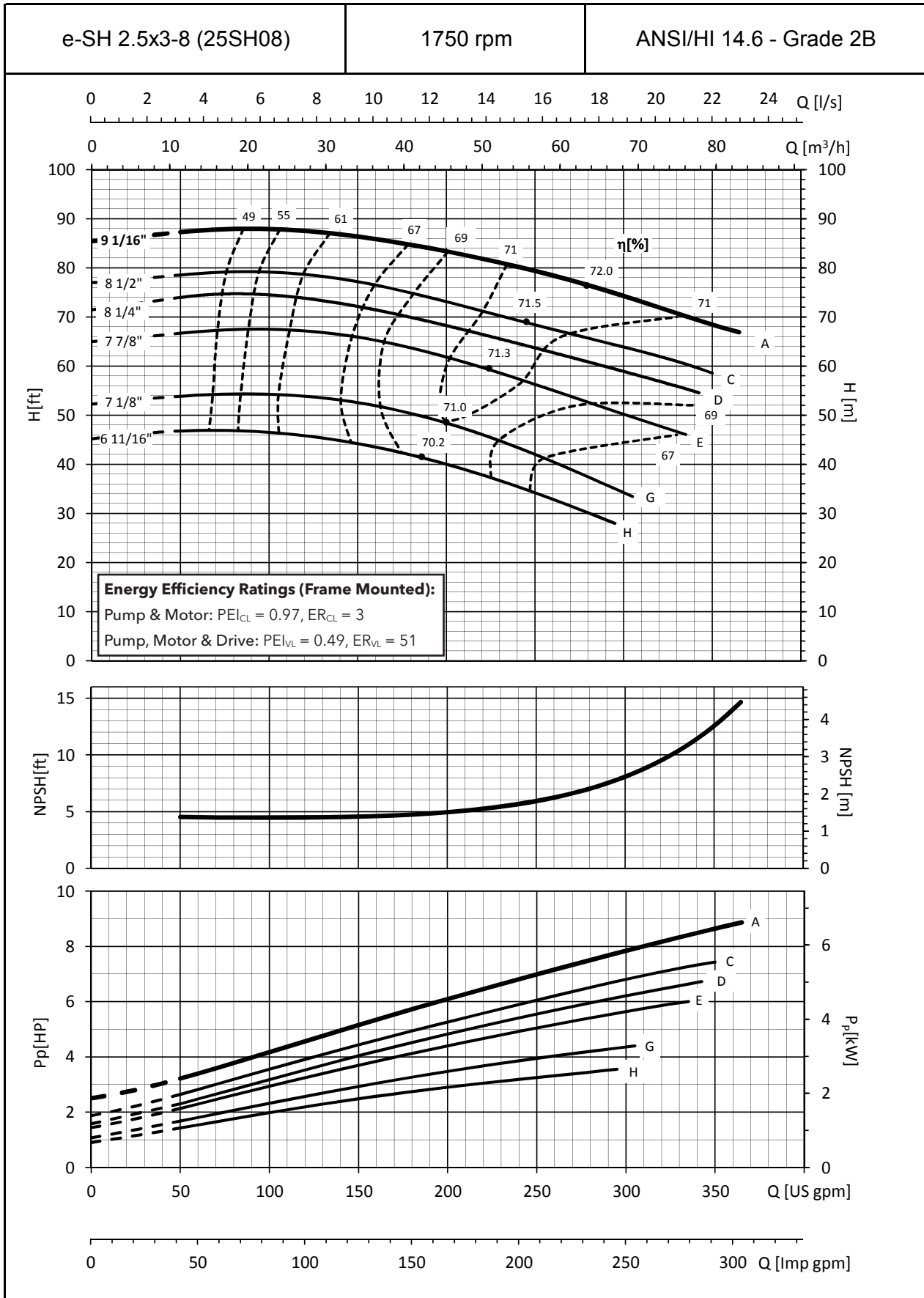

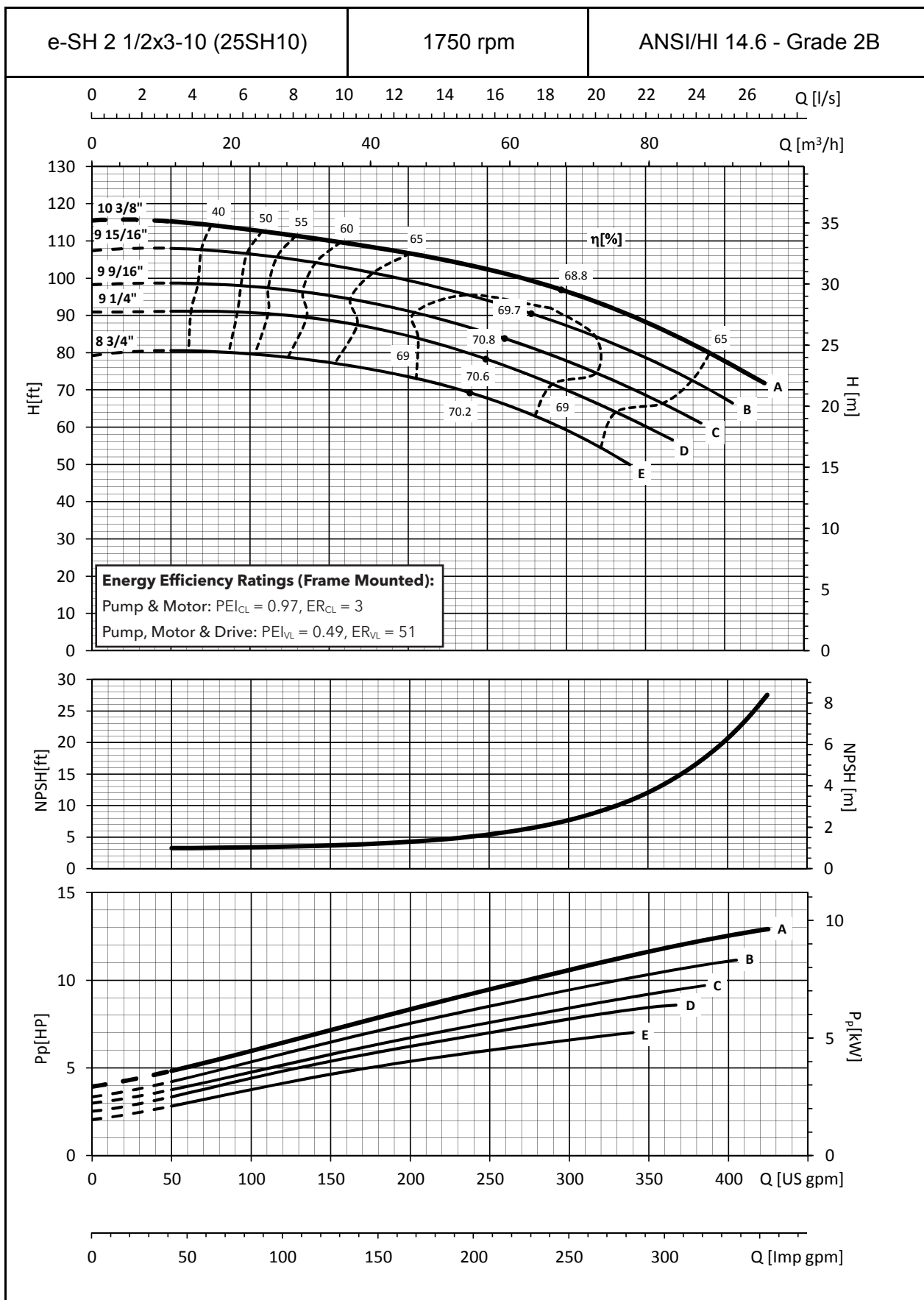

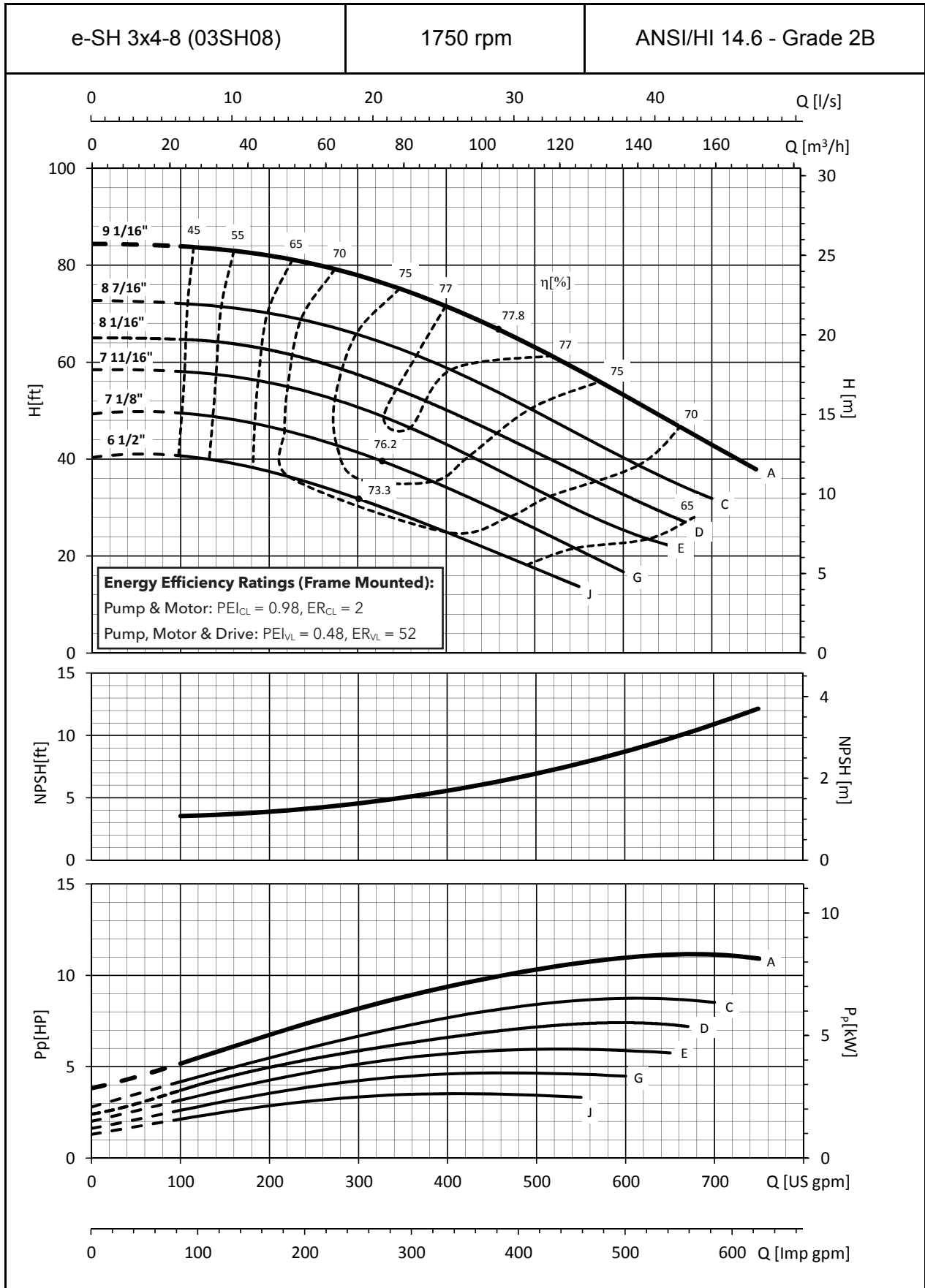

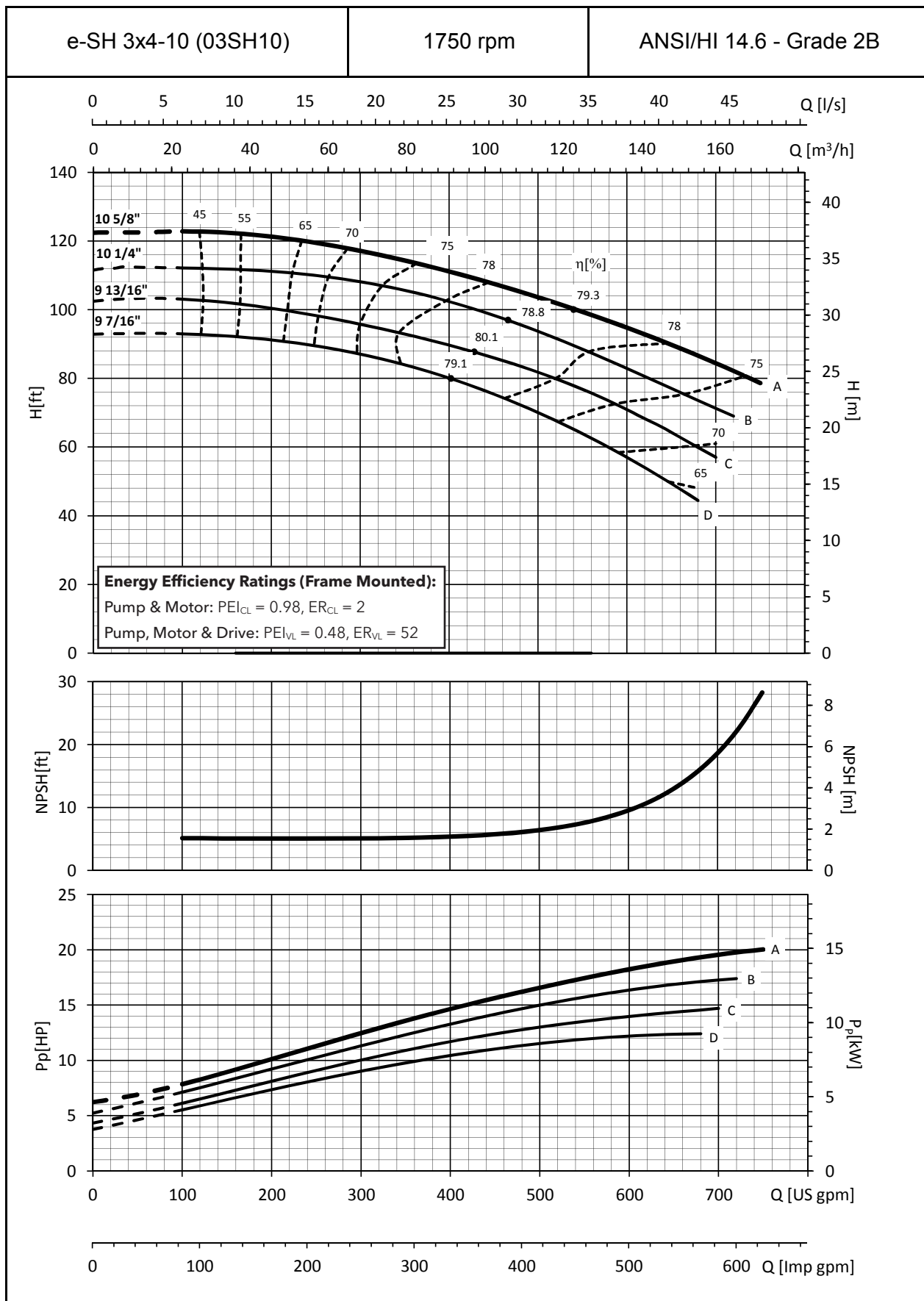

e-SH SERIES STANDARD IMPELLER TRIMS

e-SH S-Group

Impeller Code	Pump Size							
	1x2-6 01SH06	1½x2½-6 15SH06	2x2½-6 02SH06	2½x3-6 25SH06	1x2-8 01SH08	1½x2½-8 15SH08	2x2½-8 02SH08	1x2-10 01SH10
	Diameter (in)							
A	6 ¹ / ₁₆	6¾	6 ⁹ / ₁₆	7 ⁵ / ₃₂	8 ³ / ₁₆	8¼	8¼	9 ⁴¹ / ₆₄
B	5 ²⁹ / ₃₂	6 ³ / ₈	6 ³ / ₁₆	6 ²⁷ / ₃₂	7 ⁴³ / ₆₄	7 ¹³ / ₁₆	7¾	8 ¹³ / ₁₆
C	5 ³⁵ / ₆₄	6 ¹ / ₁₆	5 ¹³ / ₁₆	6½	7 ²¹ / ₆₄	7	7½	8 ²¹ / ₃₂
D	5 ²³ / ₆₄	5 ⁵ / ₈	5½	6 ¹⁹ / ₆₄	7	6¾	7 ³ / ₁₆	8 ³ / ₁₆
E	4 ⁶¹ / ₆₄	5 ⁵ / ₁₆	5 ¹ / ₈	5¾	6 ¹¹ / ₁₆	6 ⁷ / ₁₆	6 ⁷ / ₈	8
F	6 ¹ / ₁₆	4 ¹¹ / ₁₆	4 ¹³ / ₁₆	5½	6¼	6 ¹ / ₈	6 ³ / ₁₆	7¾
G		4 ³ / ₈	4 ⁷ / ₁₆					7 ¹³ / ₆₄
H		4 ³ / ₁₆						

eSH M-Group (140JM, 180JM & 210JM)

Impeller Code	Pump Size				
	1½x2½ -10 15SH10	2x2½-10 02SH10	2½x3-8 25SH08	2½x3-10 25SH10	3x4-8 03SH08
	Diameter (in)				
A	9 ⁷ / ₈	9 ⁷ / ₈	9 ¹ / ₁₆		9 ¹ / ₁₆
B	9½	9½		9 ¹⁵ / ₁₆	
C	9 ³ / ₁₆	9 ¹ / ₈	8½	9 ⁹ / ₁₆	8 ⁷ / ₁₆
D	8 ⁷ / ₈	8 ¹³ / ₁₆	8¼	9¼	8 ¹ / ₁₆
E	8 ⁹ / ₁₆	8 ³ / ₁₆	7 ⁷ / ₈	8¾	7 ¹¹ / ₁₆
F	8¼	7 ¹⁵ / ₁₆			
G		7 ¹¹ / ₁₆	7 ¹ / ₈		7 ¹ / ₈
H			6 ¹¹ / ₁₆		
J					6½
K					6
L					5½

e-SH M-Group (254JM-365TCZ)

Impeller Code	Pump Size					
	1½x2½ -10 15SH10	2x2½-10 02SH10	2½x3-8 25SH08	2½x3-10 25SH10	3x4-8 03SH08	3x4-10 03SH10
	Diameter (in)					
A	9 ⁷ / ₈	9 ⁷ / ₈	9 ¹ / ₁₆	10 ³ / ₈	9 ¹ / ₁₆	10 ⁵ / ₈
B	9½	9½	8¾	9 ¹⁵ / ₁₆	8 ¹¹ / ₁₆	10¼
C	9 ³ / ₁₆	9 ¹ / ₈	8½	9 ⁹ / ₁₆	8 ⁷ / ₁₆	9 ¹³ / ₁₆
D	8 ⁷ / ₈	8 ¹³ / ₁₆	8¼	9¼	8 ¹ / ₁₆	9 ⁷ / ₁₆
E	8 ⁹ / ₁₆	8 ³ / ₁₆	7 ⁷ / ₈	8¾	7 ¹¹ / ₁₆	9 ¹ / ₁₆
F	8¼	7 ¹⁵ / ₁₆	7½		7½	8 ¹¹ / ₁₆
G		7 ¹¹ / ₁₆	7 ⁷ / ₈		7 ¹ / ₈	
H			6 ¹¹ / ₁₆		6 ⁷ / ₈	
J			6½		6½	
K					6	
L					5½	

PUMP CROSS-SECTION AND MAIN COMPONENTS

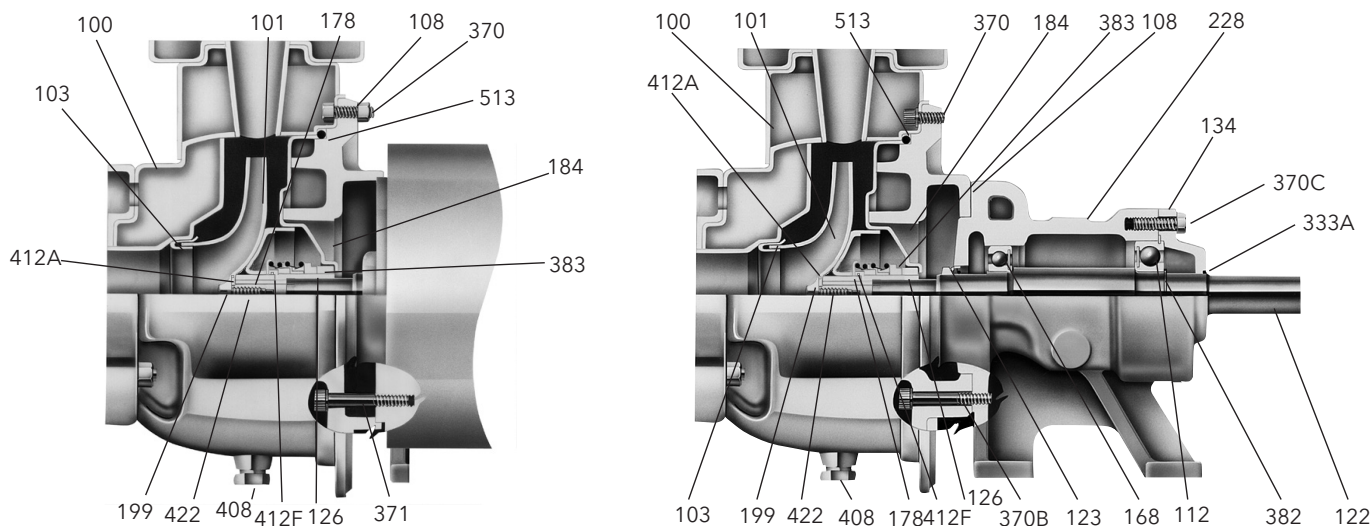

MATERIALS OF CONSTRUCTION

Item No	Name	Material	Reference Standards
100	Casing	Stainless steel 316L	EN 10088-1-X2CrNiMo17-12-2 (1.4404)
101	Impeller (01SH06, 01SH08, 01SH10, 1XSH06, 1XSH08, 1XSH10, 02SH08, 02SH10)	Stainless steel 316L	EN 10088-1-X2CrNiMo17-12-2 (1.4404)
	Impeller (02SH06, 2XSH06, 2XSH08, 2XSH10, 03SH08, 03SH10)	Stainless steel CF8M	ASTM A744
103	Wear ring	Stainless steel 316L	EN 10088-1-X2CrNiMo17-12-2 (1.4404)
108	Adapter	Gray cast iron class 20B	ASTM A48
112	Ball bearing (outboard)	Steel	
122	Pump shaft	Steel grade 1213	ASTM A108
123	Deflector	Buna-N	ASTM D2000
126	Shaft sleeve	Stainless steel 316	ASTM A276
134	Bearing cover	Gray cast iron class 20B	ASTM A48
168	Ball bearing (inboard)	Steel	
178	Impeller key	Steel	AISI 316L
184	Seal housing	Stainless steel 316L	EN 10088-1-X2CrNiMo17-12-2 (1.4404)
193	Grease fitting (M-group only)	Steel	
199	Impeller washer	Stainless steel CF8M	ASTM A744
228	Bearing frame	Gray cast iron class 20B	ASTM A48 Class 20
333A	Lip seal (1XSH10, 02SH10, 2XSH08, 2XSH10, 03SH08, 03SH10)	Steel/Buna-N	
	V-ring (01SH06, 01SH08, 01SH10, 1XSH06, 1XSH08, 02SH06, 02SH08, 2XSH06)	Buna-N	ASTM D2000
370	Casing bolt with nut (casing to adapter)	Stainless Steel	ASTM F593/F594
370B	Hex head cap screw (adapter to bearing frame)	Steel	SAE J429 Grade 5
370C	Hex head cap screw (bearing frame to cover)	Steel	SAE J429 Grade 6
371	Hex head cap screw (adapter to motor)	Steel	SAE 1200
382	Retaining ring	Steel	
383	Mechanical seal	See Chart	
408	Drain plug - 3/8 BSP	Stainless steel	EN 10088-1-X5CrNiMo17-12-2 (1.4401)
412A	O-ring, impeller	FKM (standard version)	ASTM D2000
412F	O-ring, shaft sleeve	FKM (standard version)	ASTM D2000
422	Impeller Stud	Carbon steel	ASTM A307
513	O-ring	FKM (standard version)	ASTM D2000

MOTOR SIZING

Pump Size	3500 RPM				1750 RPM			
	Trim	Maximum HP draw	Motor Selection using SF = 1	Motor Selection using SF = 1.15	Trim	Maximum HP draw	Motor Selection using SF = 1	Motor Selection using SF = 1.15*
			Rated HP	Rated HP			Rated HP	Rated HP
01SH06	A	5.2	7½	5	A	0.7	¾	¾
	B	4.1	5	5	B	0.6	¾	½
	C	3.1	5	3	C	0.4	½	½
	D	2.7	3	3	D	0.4	½	½
	E	2.0	2	2	E	0.3	½	½
01SH08	A	12.5	15	15	A	1.6	2	1½
	B	10.0	10	10	B	1.2	1½	1½
	C	8.4	10	7½	C	1.1	1½	1
	D	7.1	7½	7½	D	0.9	1	1
	E	5.3	7½	5	E	0.7	¾	¾
	F	4.1	5	5	F	0.5	½	½
01SH10	A	22.7	25	20	A	2.9	3	3
	B	17.4	20	20	B	2.1	3	2
	C	14.6	15	15	C	1.8	2	2
	D	12.1	15	15	D	1.5	1½	1½
	E	11.0	15	10	E	1.4	1½	1½
	F	10.1	15	10	F	1.3	1½	1½
	G	7.4	7½	7½	G	1.0	1	1
15SH06	A	9.7	10	10	A	1.1	1½	1
	B	7.4	7½	7½	B	0.9	1	1
	C	6.4	7½	7½	C	0.8	1	¾
	D	5.3	7½	5	D	0.7	¾	¾
	E	4.3	5	5	E	0.5	½	½
	F	2.9	3	3	F	0.4	½	½
	G	2.5	3	3	G	0.3	½	½
	H	2.2	3	2	H	0.3	½	½
15SH08	A	17.5	20	20	A	2.2	3	2
	B	14.6	15	15	B	1.9	2	2
	C	10.7	15	10	C	1.4	1½	1½
	D	9.5	10	10	D	1.2	1½	1
	E	8.2	10	7½	E	1.1	1½	1
	F	7.0	7½	7½	F	0.9	1	1
15SH10	A	32.2	40	30	A	4.2	5	5
	B	27.6	30	25	B	3.8	5	5
	C	24.9	25	25	C	3.5	5	5
	D	22.7	25	20	D	3.2	5	3
	E	20.2	25	20	E	2.9	3	3
	F	18.3	20	20	F	2.6	3	3
02SH06	A	17.7	20	20	A	2.3	3	2
	B	14.2	15	15	B	1.8	2	2
	C	11.5	15	10	C	1.5	1½	1½
	D	9.5	10	10	D	1.3	1½	1½
	E	7.6	10	7½	E	1.0	1	1
	F	5.9	7½	7½	F	0.8	1	¾
	G	4.5	5	5	G	0.6	¾	½

MOTOR SIZING (cont.)

Pump Size	3500 RPM				1750 RPM			
	Trim	Maximum HP draw	Motor Selection using SF = 1	Motor Selection using SF = 1.15	Trim	Maximum HP draw	Motor Selection using SF = 1	Motor Selection using SF = 1.15*
			Rated HP	Rated HP			Rated HP	Rated HP
02SH08	A	26.5	30	25	A	3.4	5	3
	B	23.5	25	25	B	3.0	3	3
	C	21.5	25	20	C	2.8	3	3
	D	19.9	20	20	D	2.6	3	3
	E	17.8	20	20	E	2.3	3	2
	F	13.6	15	15	F	1.8	2	2
02SH10	A	47.1	50	50	A	6.2	7½	7½
	B	42.9	50	40	B	5.6	7½	5
	C	38.1	40	40	C	5.0	5	5
	D	33.9	40	30	D	4.3	5	5
	E	27.6	30	25	E	3.6	5	5
	F	24.7	25	25	F	3.2	5	3
	G	22.4	25	20	G	2.9	3	3
25SH06	A	27.1	30	25	A	3.5	5	5
	B	22.9	25	20	B	3.0	3	3
	C	19.5	20	20	C	2.4	3	3
	D	17.1	20	15	D	2.3	3	2
	E	13.7	15	15	E	1.7	2	1½
	F	11.2	15	10	F	1.4	1½	1½
25SH08	A	69.6	75	75	A	8.9	10	10
	B	63.4	75	60				
	C	58.7	60	60	C	7.4	7½	7½
	D	53.8	60	50	D	6.7	7½	7½
	E	46.0	50	40	E	6.0	7½	7½
	F	40.0	40	40				
	G	34.5	40	30	G	4.4	5	5
	H	29.0	30	30	H	3.6	5	5
25SH10	A	91.5	100	100	A	12.7	15	15
	B	80.0	100	75	B	11.1	15	10
	C	71.5	75	75	C	9.7	10	10
	D	65.0	75	60	D	8.6	10	7½
	E	54.5	60	50	E	6.9	7½	7½
03SH08	A	85.0	100	75	A	11.1	15	10
	B	75.0	75	75				
	C	69.0	75	60	C	8.6	10	7½
	D	57.0	60	50	D	7.3	7½	7½
	E	47.0	50	50	E	6.0	7½	7½
	F	43.0	40	40				
	G	36.5	40	40	G	4.8	5	5
	H	33.0	40	30				
	J	27.0	30	25	J	3.6	5	5
	K	20.0	20	20				
03SH10	C	108	100	100	A	20.0	20	20
	D	93	100	100	B	17.3	20	20
	E	82	100	75	C	14.7	15	15
	F	71	75	75	D	12.4	15	15

*SF=1.25 for motors with HP<1

PERFORMANCE CURVES AT 50 HZ, 2-POLES

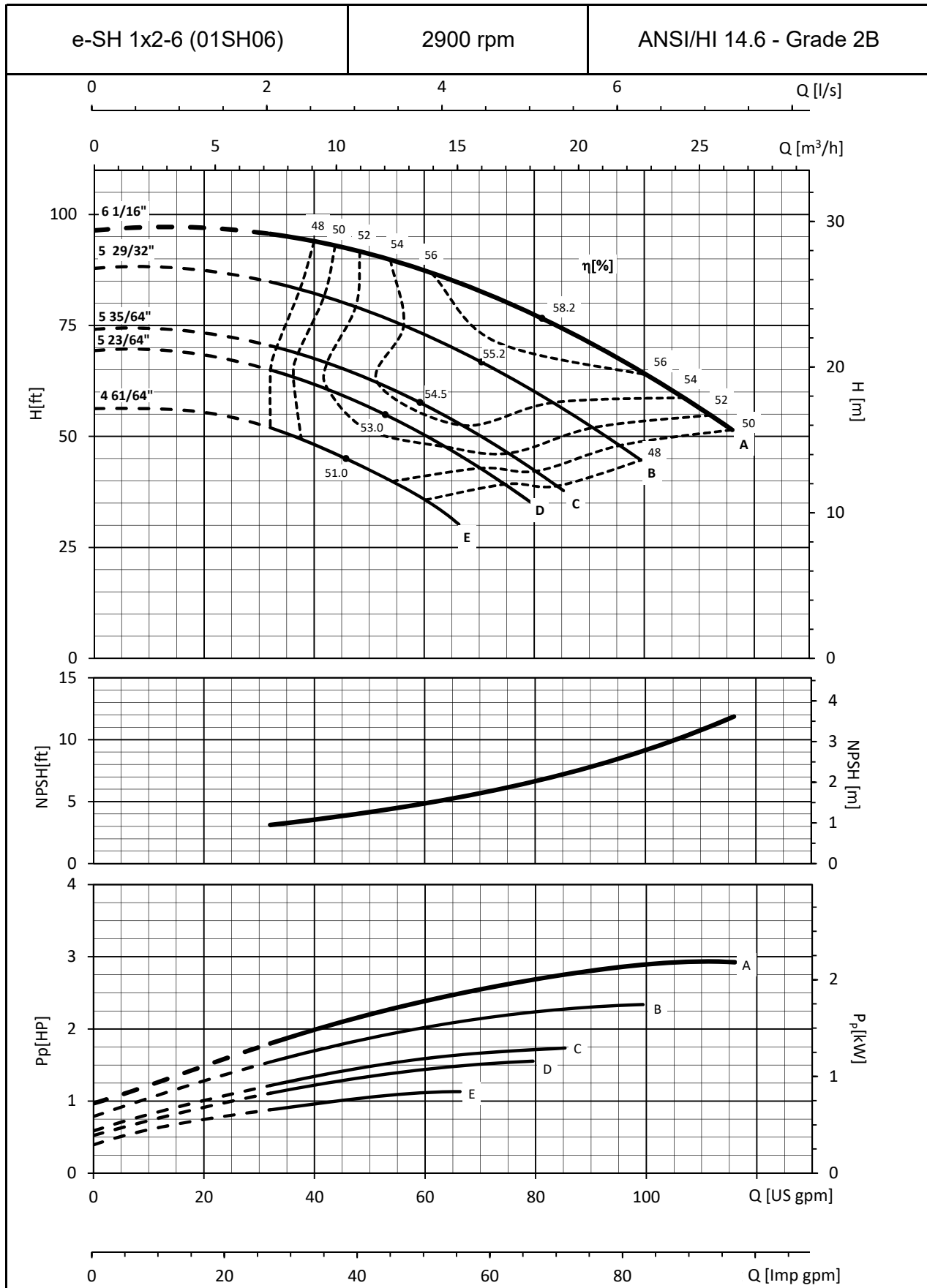

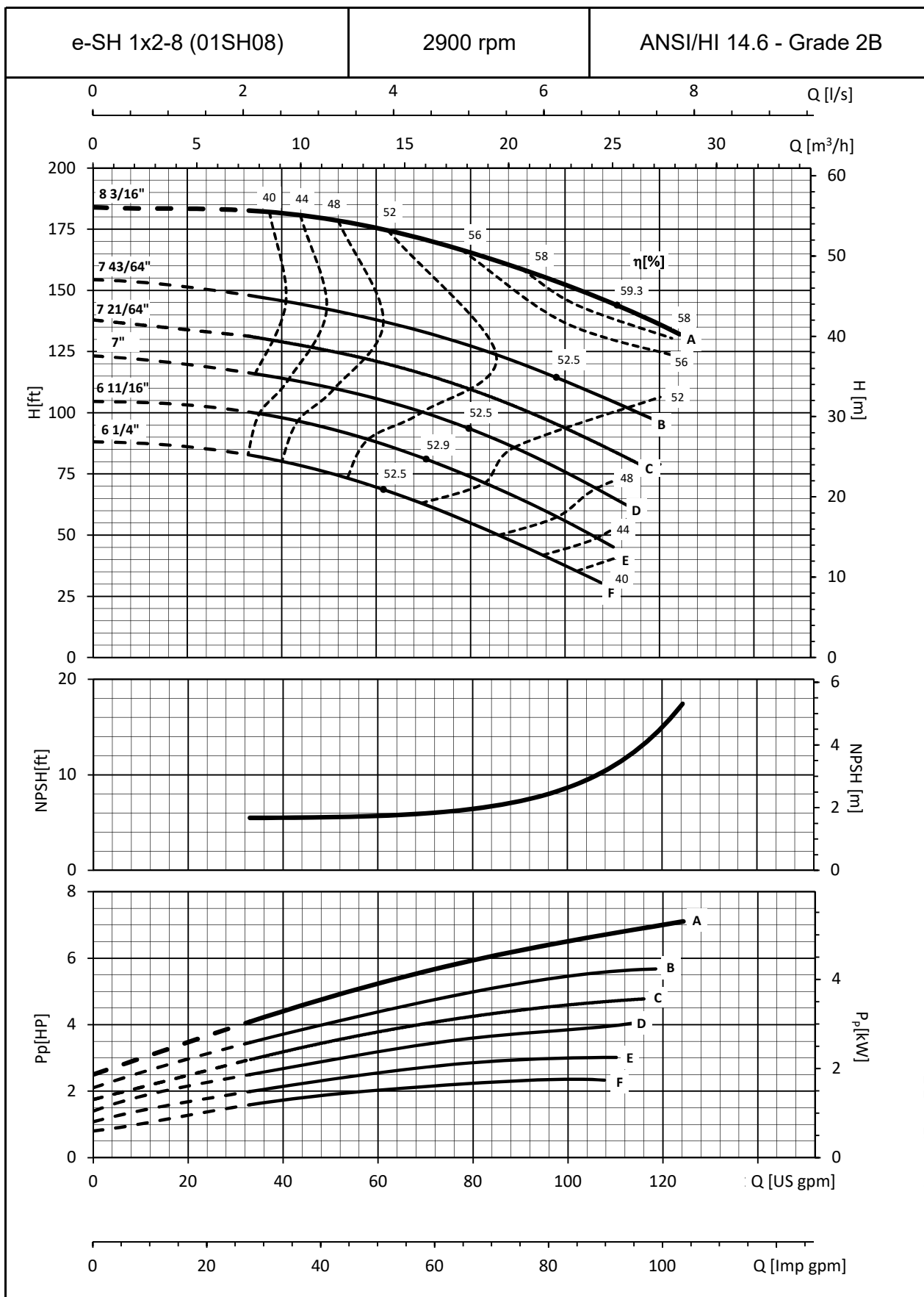

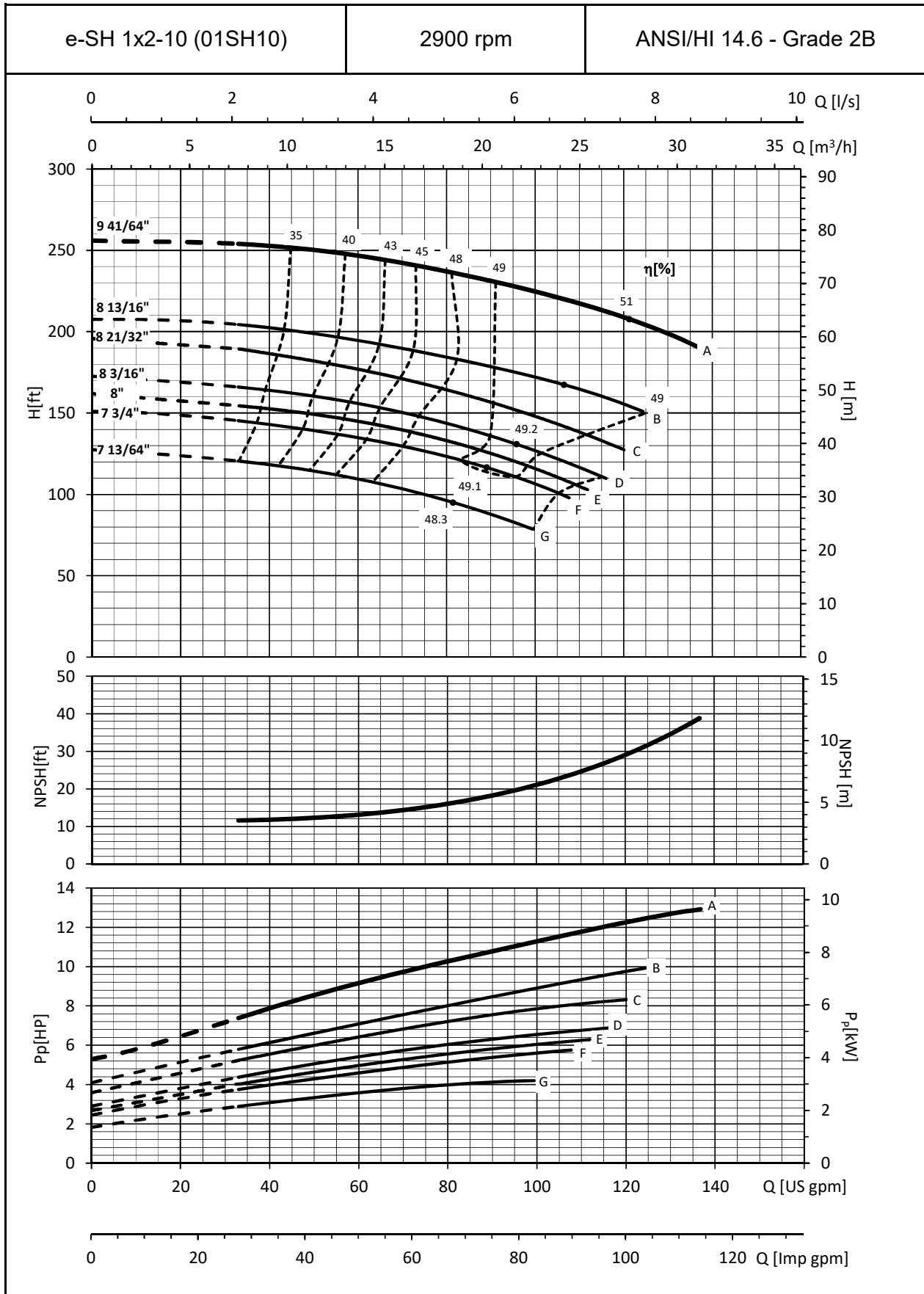

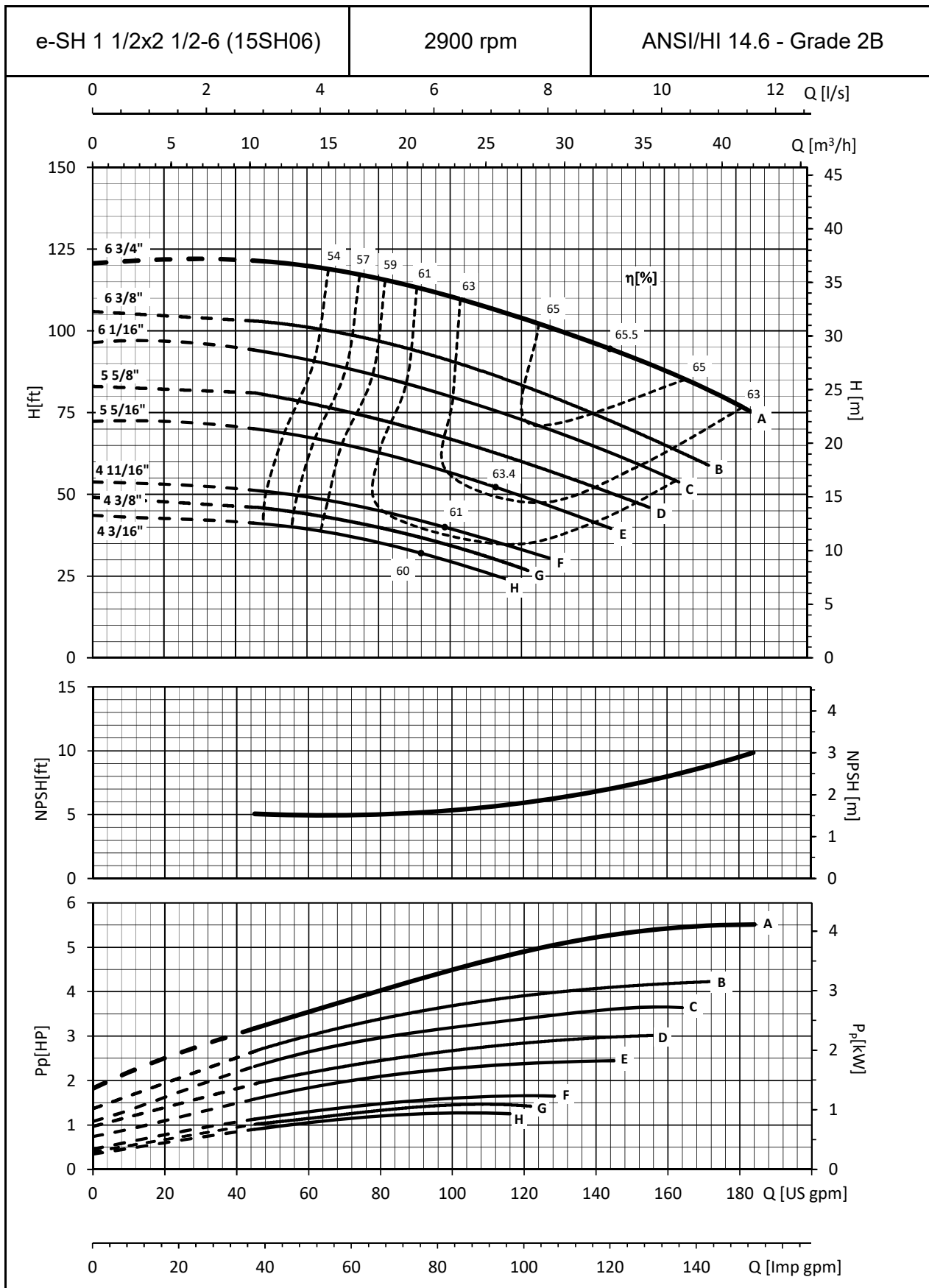

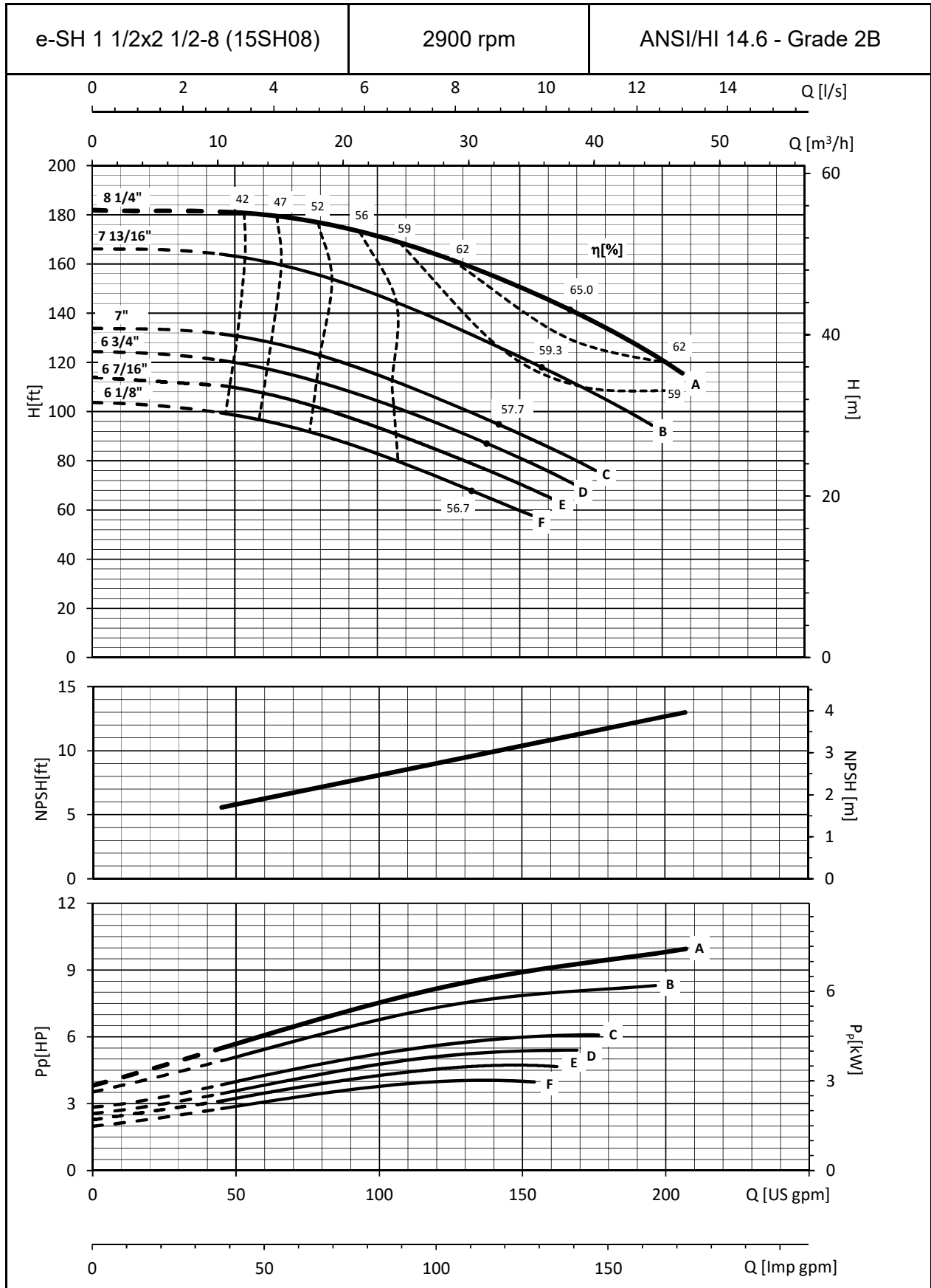

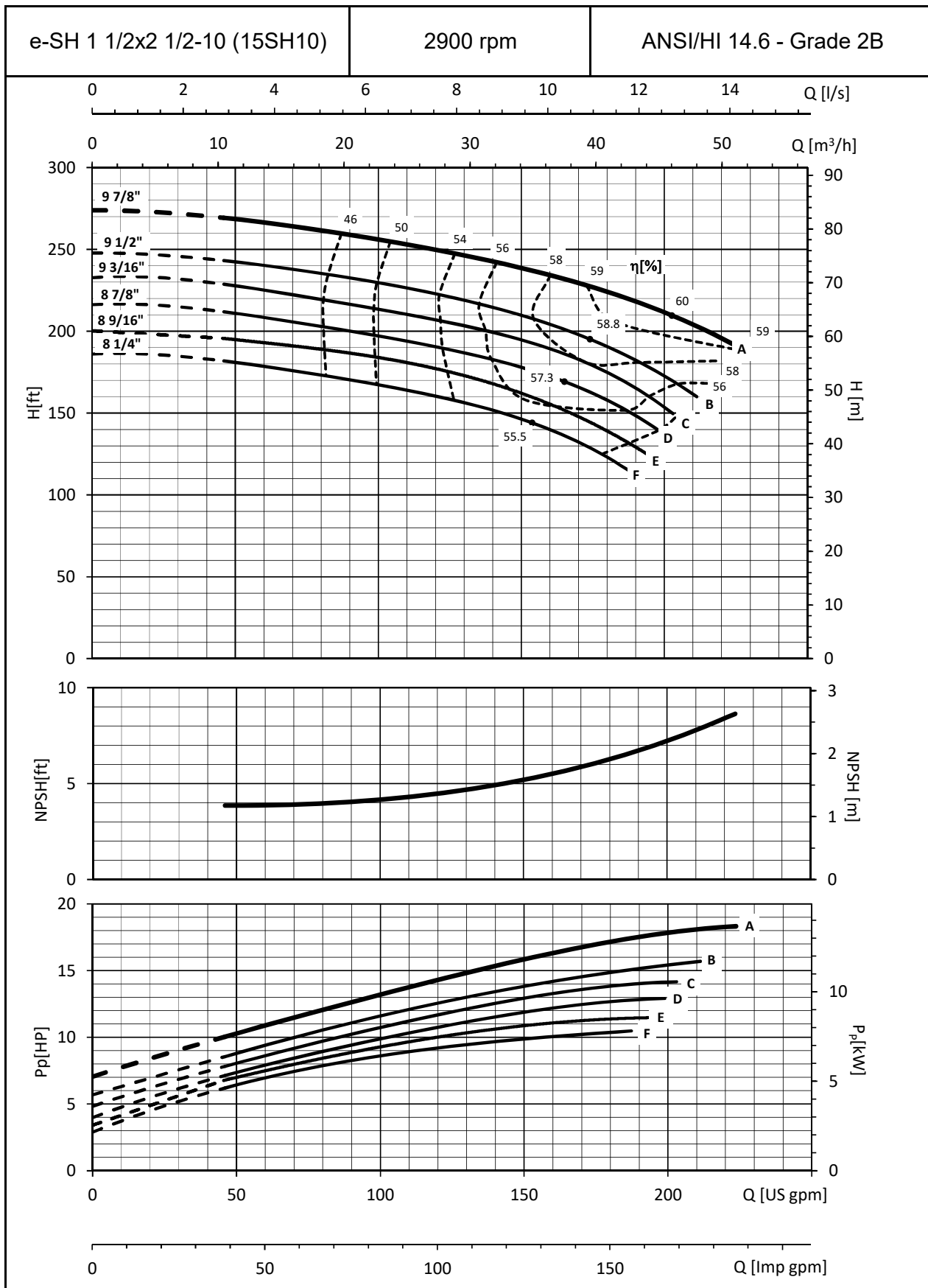

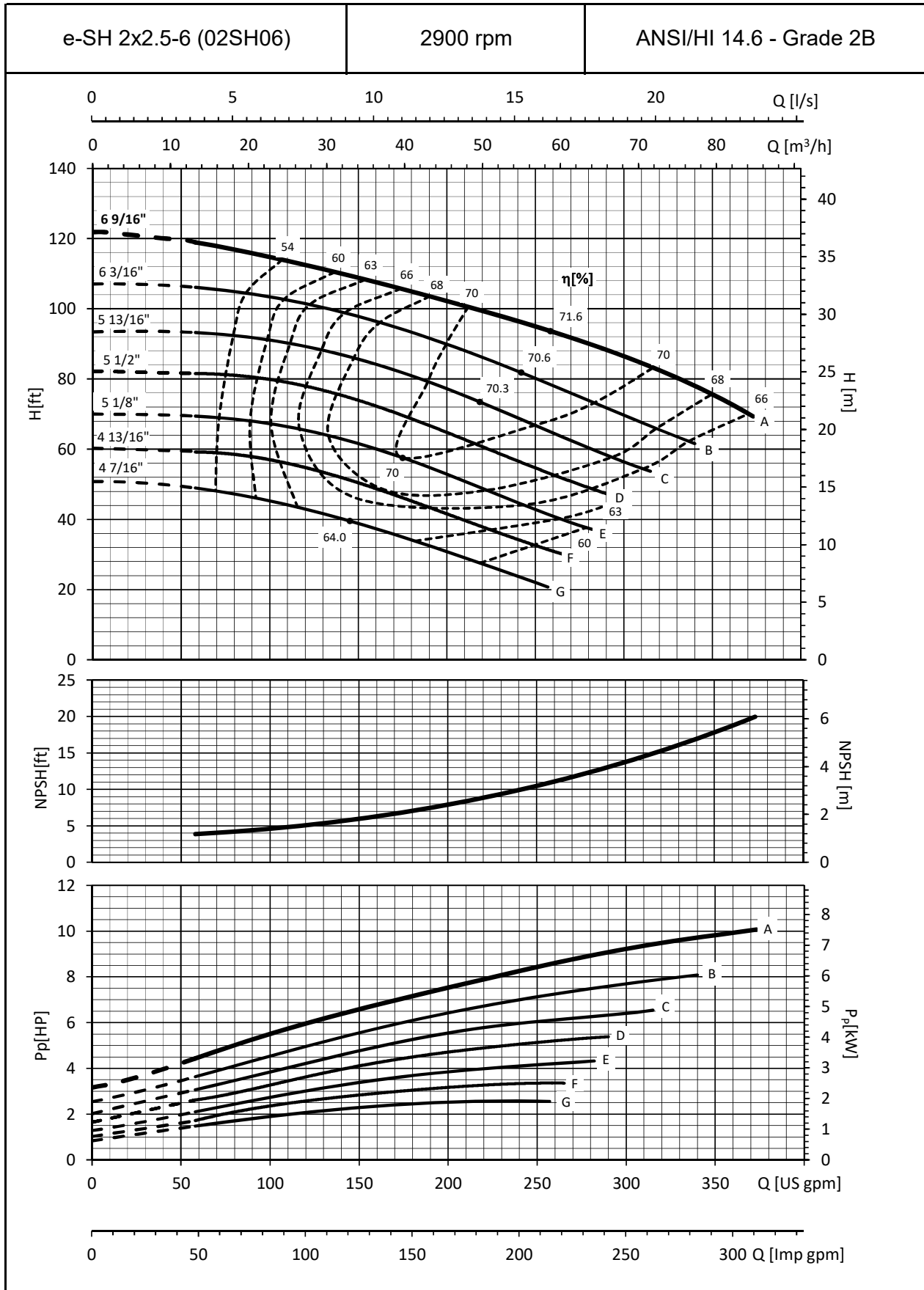

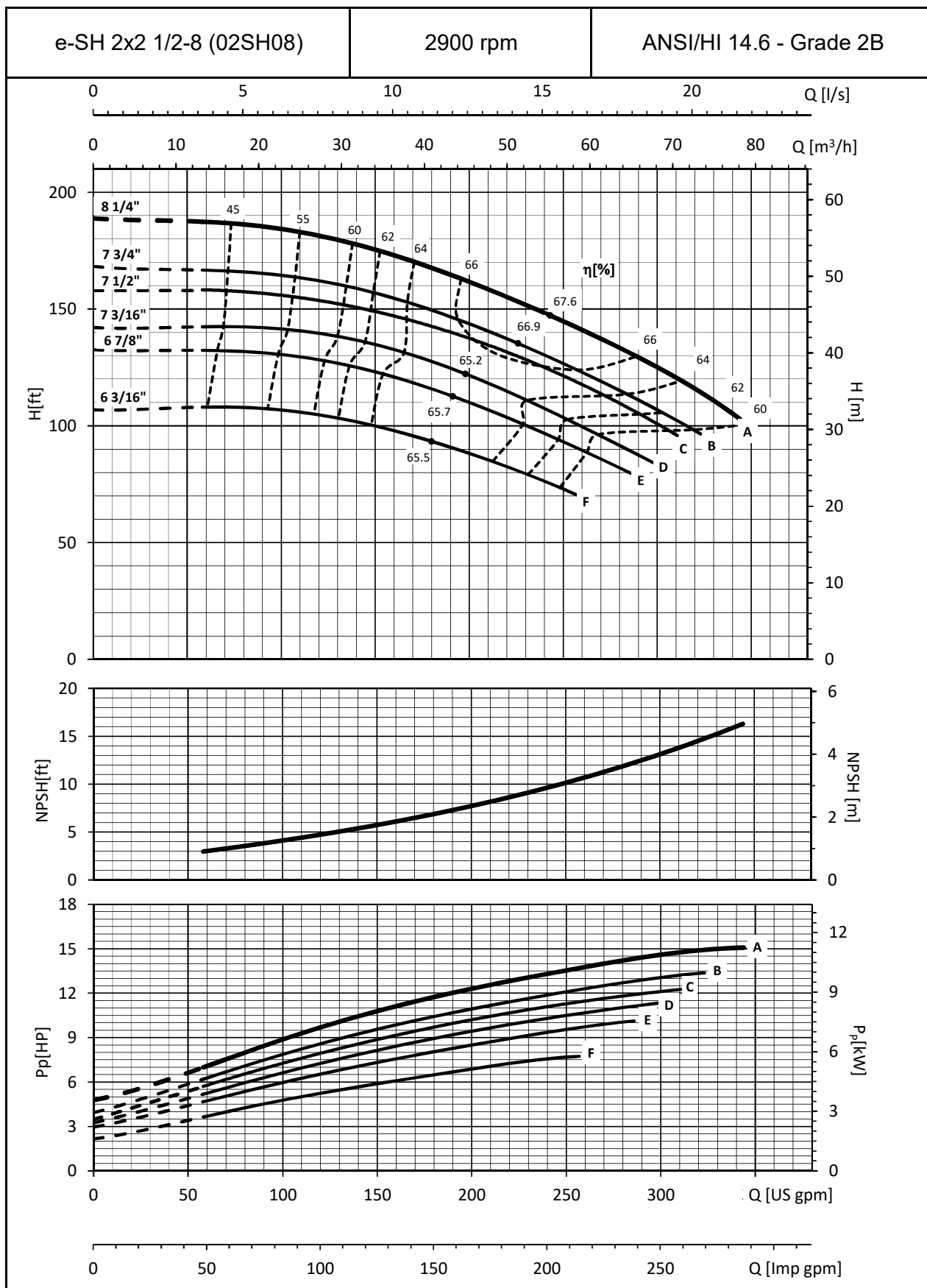

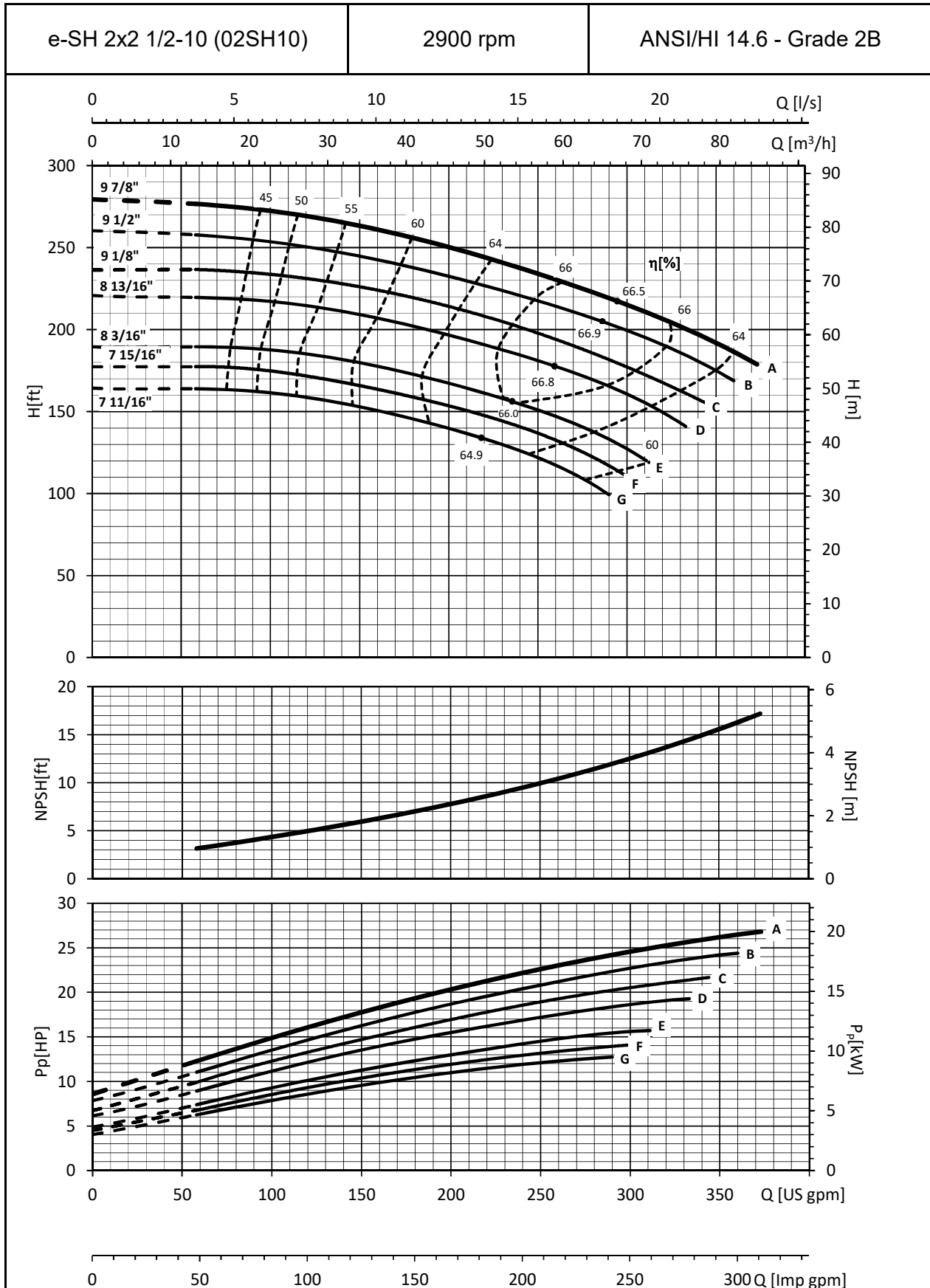

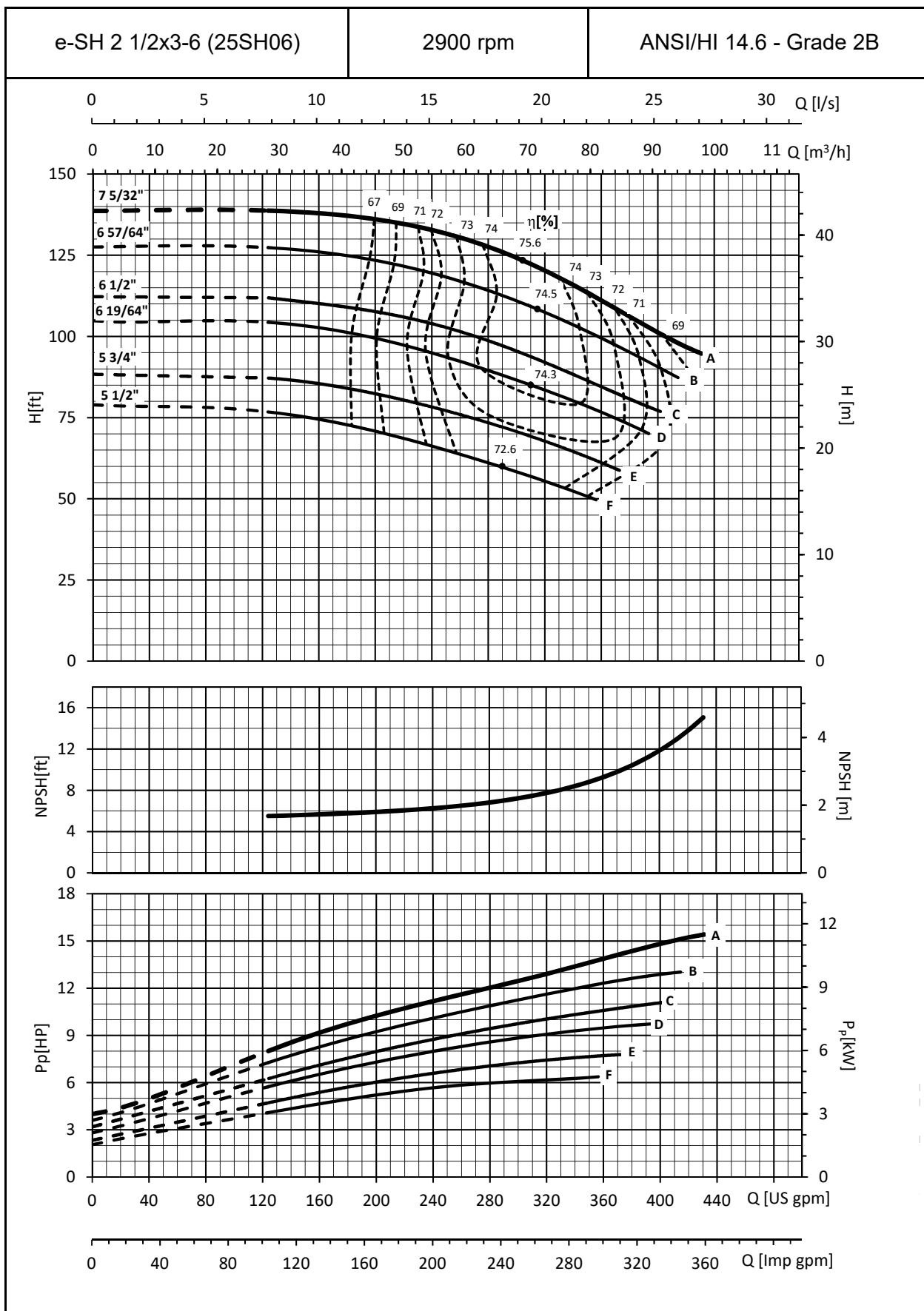

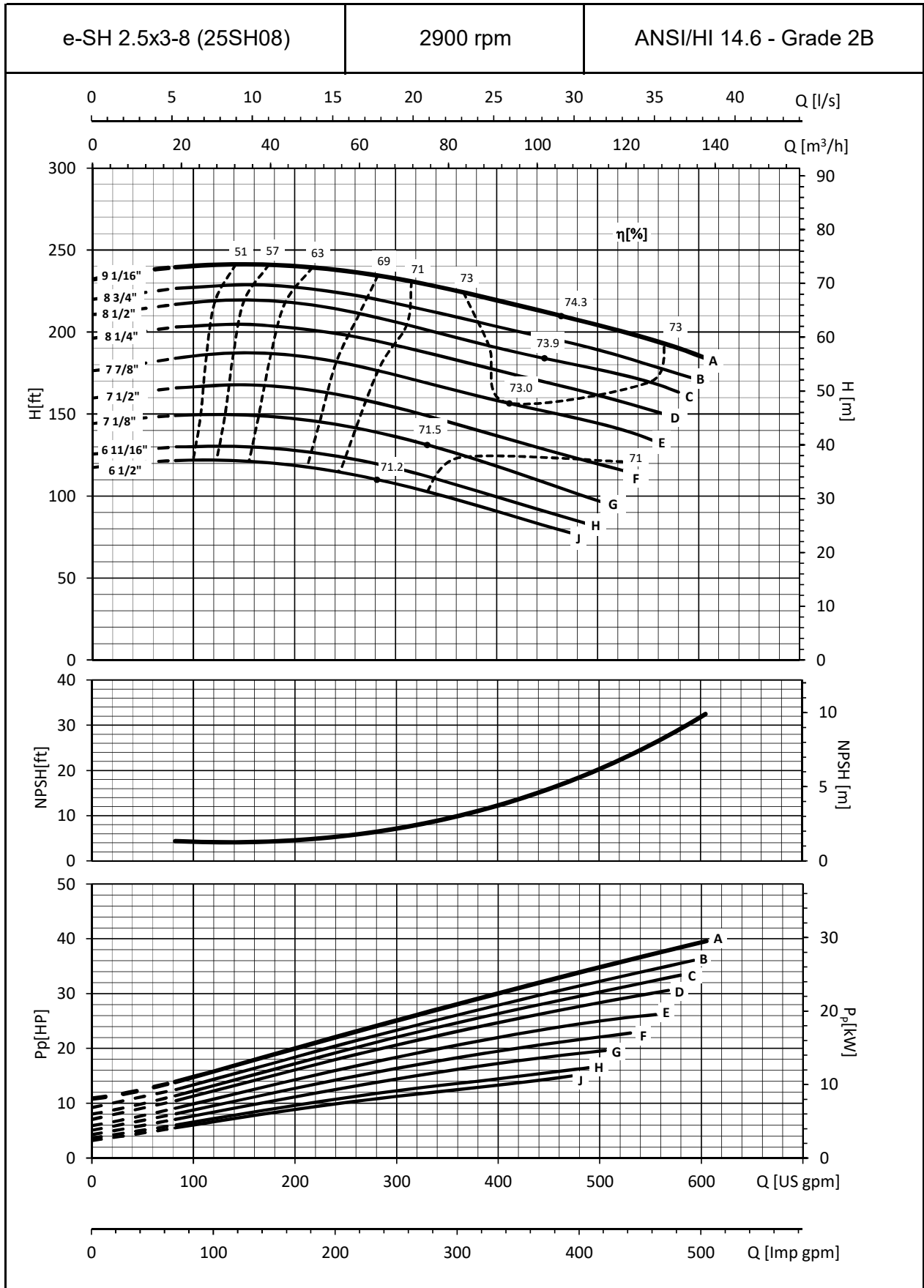

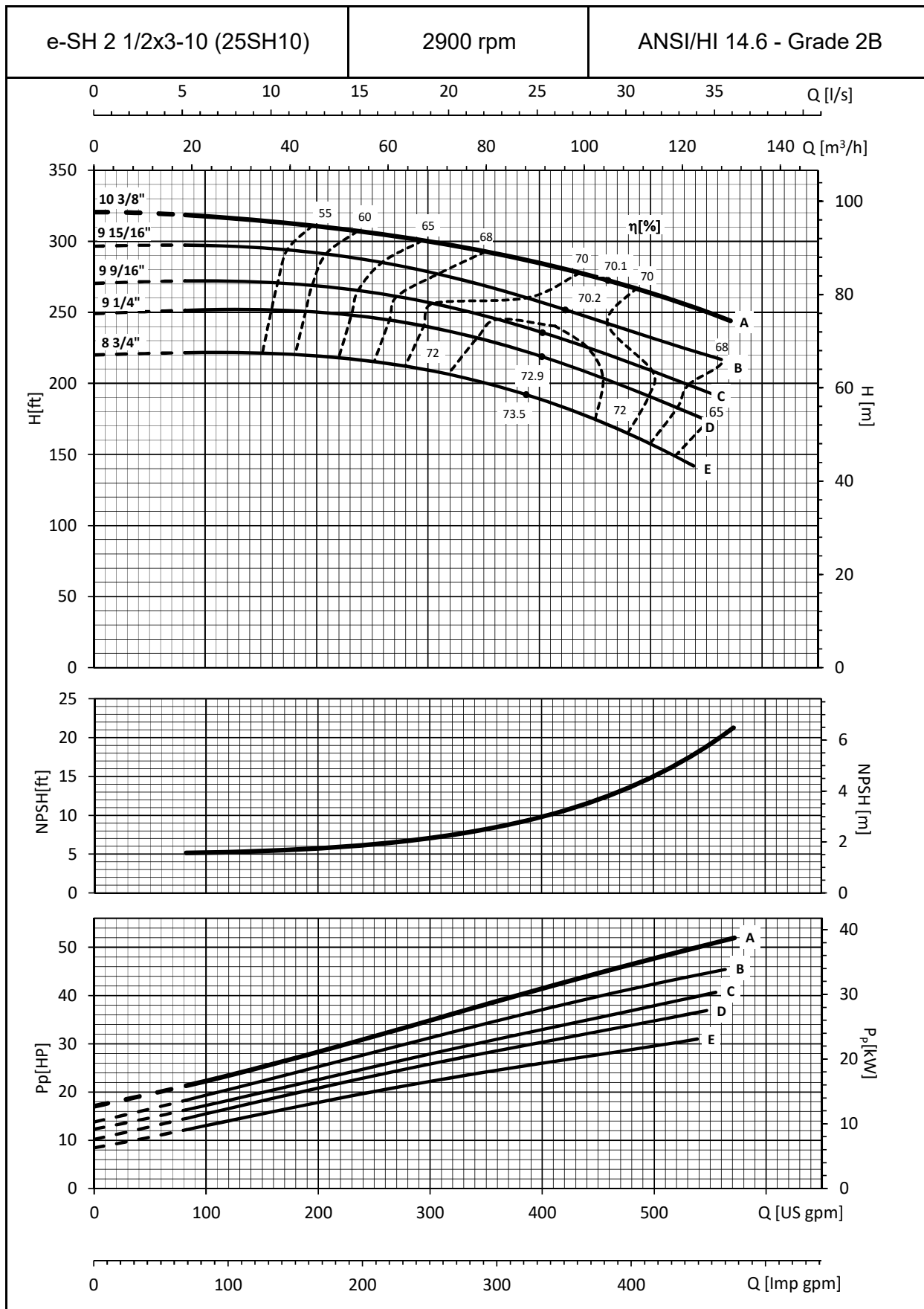

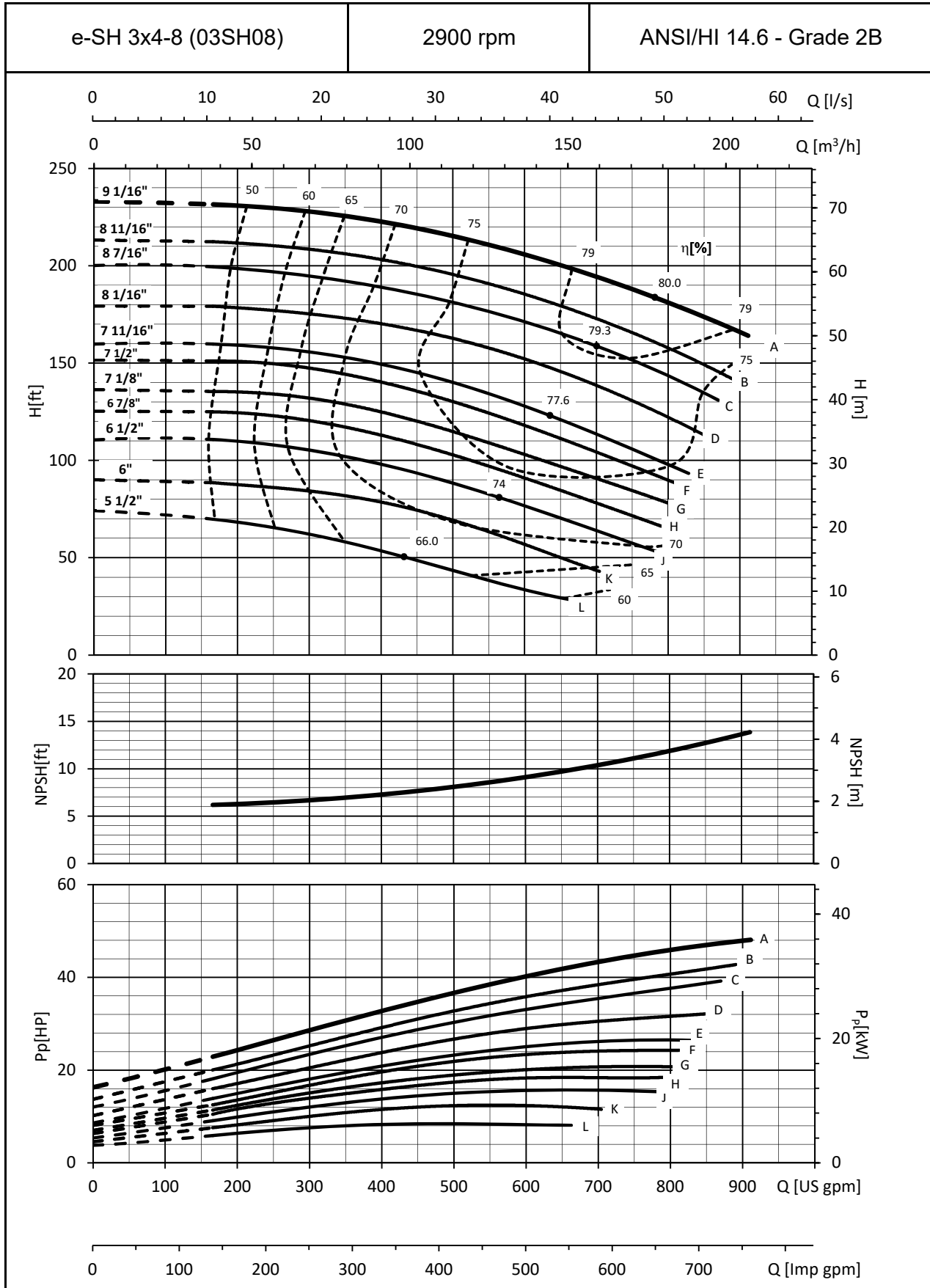

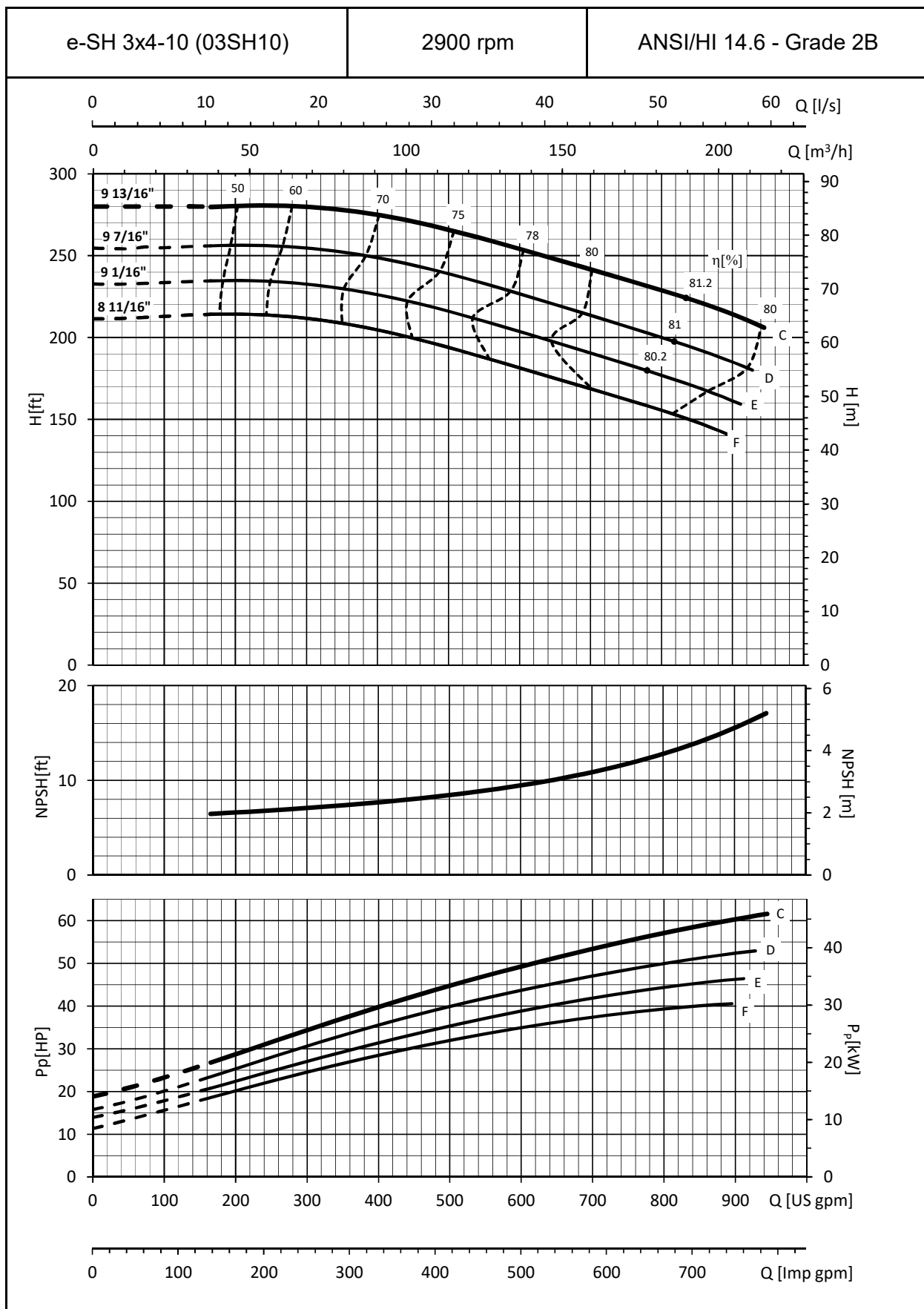

e-SH CLOSE COUPLED S-GROUP - DIMENSIONS AND WEIGHTS

(All dimensions in inches and weights in lbs. Do not use for construction purposes.)

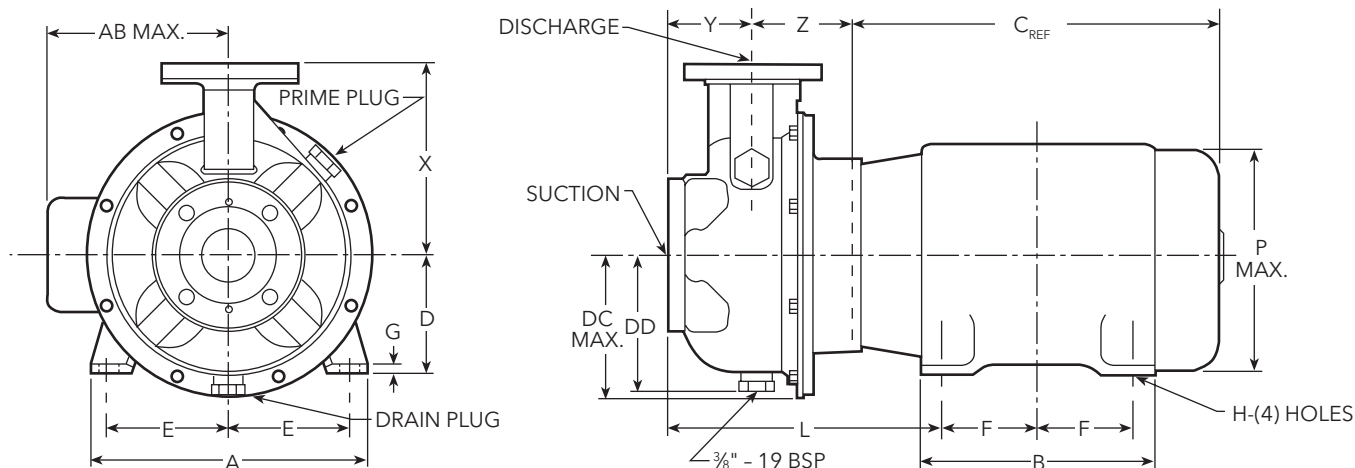

Pump	Pump Size	150 lb. Flange		DC Max.	DD	X	Y	Z	Dimensions "L" (Motor Frame Size)				Weight (lbs.)
		Suction*	Discharge*						143/145	182/184	213/215	254/256	
01SH06	1 x 2 - 6	2	1	5	4 ⁵ / ₈	6 ³ / ₈	3 ³ / ₈	3 ⁷ / ₈	9 ⁷ / ₈	10 ¹ / ₂	11 ¹ / ₂	-	36.5
01SH08	1 x 2 - 8			5 ⁵ / ₈	5 ¹ / ₄	7 ¹ / ₈			10 ³ / ₈	11 ³ / ₈	12 ³ / ₈	12 ⁷ / ₈	66
01SH10	1 x 2 - 10			6 ⁷ / ₈	6 ¹ / ₄	8 ⁷ / ₈			4	10 ³ / ₄	11 ³ / ₈	12 ³ / ₈	12 ⁷ / ₈
15SH06	1 ¹ / ₂ x 2 ¹ / ₂ - 6	2 ¹ / ₂	1 ¹ / ₂	5	4 ⁵ / ₈	6 ³ / ₈	3 ³ / ₄	3 ³ / ₈	9 ³ / ₄	10 ³ / ₈	11 ³ / ₈	-	37.7
15SH08	1 ¹ / ₂ x 2 ¹ / ₂ - 8			5 ⁵ / ₈	5 ¹ / ₄	7 ¹ / ₈			10 ³ / ₄	11 ³ / ₈	12 ³ / ₈	12 ⁷ / ₈	48.2
02SH06	2 x 2 ¹ / ₂ - 6			2	2	5			4 ⁵ / ₈	7 ¹ / ₈	4	3 ³ / ₈	10 ¹ / ₂
02SH08	2 x 2 ¹ / ₂ - 8	6	5 ³ / ₄			7 ¹ / ₈	10 ⁵ / ₈	11 ³ / ₈	12 ³ / ₈				12 ⁷ / ₈
25SH06	2 ¹ / ₂ x 3 - 6	3	2 ¹ / ₂	6	5 ³ / ₄	7 ¹ / ₈	4	3 ⁷ / ₈	10 ⁵ / ₈	11 ³ / ₈	12 ³ / ₈	12 ⁷ / ₈	61.8

* For use with ANSI class 150 mating flanges.

NOTE:

1. Pumps shipped in vertical discharge as standard. For other orientations, remove casing bolts, rotate discharge to desired position, and tighten ³/₈ - 16 bolts to 20 ft./lbs., ⁷/₁₆ - 14 bolts to 20 ft./lbs.
2. ALL dimensions in inches.
3. Motor dimensions may vary with motor manufacturer.
4. Not for construction purposes.

Dimensions Determined by JM Motor Frame

JM Frame	A	AB Max.	B	D	E	F	G	C Max.	H Dia.	P Max.	Motor Wt. (lbs.)
143JM	6 ¹ / ₂	5 ³ / ₄	6	3 ¹ / ₂	2 ³ / ₄	2	1 ¹ / ₈	11 ³ / ₁₆	1 ¹¹ / ₃₂	7 ³ / ₁₆	50
145JM						2 ¹ / ₂					54
182JM	8 ⁵ / ₈	6 ⁷ / ₈	6 ¹ / ₂	4 ¹ / ₂	3 ³ / ₄	2 ¹ / ₄	3 ³ / ₁₆	13 ⁴ / ₅	1 ¹³ / ₃₂	8 ⁵ / ₈	76
184JM						2 ³ / ₄					101
213JM	9 ¹ / ₂	8 ² / ₅	8	5 ¹ / ₄	4 ¹ / ₄	2 ³ / ₄	3 ³ / ₁₆	15 ¹⁴ / ₂₅	1 ¹³ / ₃₂	10 ⁷ / ₂₅	134
215JM						3 ¹ / ₂					169
254TCZ	11 ¹ / ₂	10 ² / ₅	11 ¹ / ₂	6 ¹ / ₄	5	4 ¹ / ₈	7 ⁷ / ₈	20 ¹ / ₂₀	1 ¹⁷ / ₃₂	13 ¹³ / ₅₀	276
256TCZ						5					298

Motor Frame Selections

Motor Frame	Motor Horsepower							
	3500 RPM				1750 RPM			
	1 PH		3 PH		1 PH		3 PH	
	ODP*	TEFC*	ODP*	TEFC*	ODP*	TEFC*	ODP*	TEFC*
143JM	-	-	-	-	-	-	1	1
145JM	2	2	2-3	2	1-1 ¹ / ₂	1-1 ¹ / ₂	1 ¹ / ₂ -2	1 ¹ / ₂ -2
182JM	3	3	5	3	2	2-3	3	3
184JM	5	5	7 ¹ / ₂	5	3	-	5	5
213JM	7 ¹ / ₂	-	10	7 ¹ / ₂	5	-	7 ¹ / ₂	7 ¹ / ₂
215JM	10	-	15	10-15	-	-	-	-
254TCZ	-	-	20	15**	-	-	-	-
256TCZ	-	-	25	20	-	-	-	-

* Premium efficiency where required by Department of Energy regulations.

** Frame size for 208-230/460 Voltage TEPE motor.

e-SH CLOSE COUPLED M-GROUP - DIMENSIONS AND WEIGHTS

(All dimensions in inches and weights in lbs. Do not use for construction purposes.)

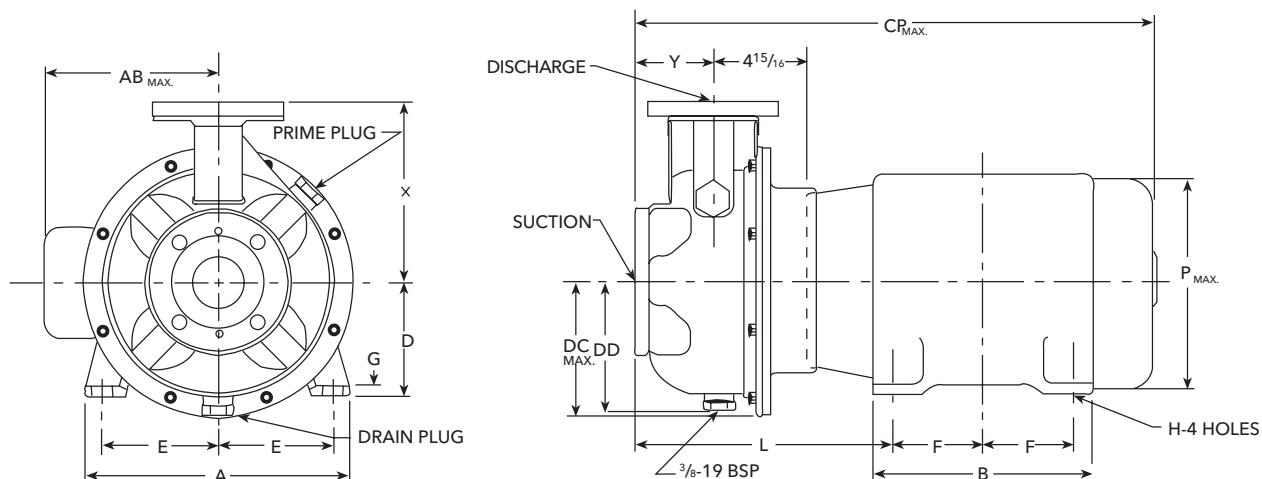

Dimensions "L" Determined by Pump and Motor

Pump	Pump Size	Suction*	Discharge*	CP Max.	DC Max.	DD	X	Y	Wt. (lbs.)	Motor Frame Size					
										140	180	210	250	280	320
15SH10	1½ x 2½-10	2½	1½	34 ³ / ₈	6 ⁷ / ₈	6¼	8 ¹⁵ / ₁₆	4	92.1	11 ⁷ / ₈	12½	13½	13 ⁷ / ₈	14 ³ / ₈	-
02SH10	2 X 2½-10		2						86						15
25SH08	2½ X 3-8	3	2½	36 ³ / ₄	6 ¹ / ₈	6 ¹ / ₈	9 ¹⁵ / ₁₆	5	85.9	-	-	-	-	-	15
25SH10	2½ X 3-10								95.3						
03SH08	3 X 4-8	4	3	37 ³ / ₄	7 ⁵ / ₈	7 ³ / ₈	11 ¹ / ₈	5	108.3	12 ⁷ / ₈	13½	14½	14 ⁷ / ₈	15 ³ / ₈	16
03SH10	3 X 4 -10								113.2	-	-				

* For use with ANSI class 150 mating flanges.

NOTES:

1. Pumps shipped in vertical discharge as standard. For other orientations, remove casing bolts, rotate discharge to desired position, and tighten ¾ - 16 bolts to 20 ft./lbs., 7/16 - 14 bolts to 20 ft./lbs., ½ - 13 bolts to 40 ft./lbs.
2. Motor dimensions may vary with motor manufacturer.
3. Not for construction purposes.

Dimensions Determined by JM Motor Frame

JM Frame	A	AB Max.	B	D	E	F	G	H Dia.	P Max.
145JM	6½	5¾	6	3½	2¾	2½	1/8	11/32	7 ³ / ₁₆
182JM	8 ⁵ / ₈	6 ⁷ / ₈	6½	4½	3¾	2¼	3/16	9/20	8 ⁵ / ₈
184JM						2¾			
213JM	9½	8 ¹ / ₂₅	8	5¼	4¼	3½	3/16	17/32	10 ⁹ / ₁₆
215JM						4 ¹ / ₈			
254JM	11½	10 ¹ / ₂₅	11½	6¼	5	4 ¹ / ₈	7/8	17/32	13¼
256JM						5			
284JM	12¾	16 ¹³ / ₂₀	12 ²¹ / ₂₅	7	5½	4¾	11/16	17/32	15 ²⁷ / ₆₄
286JM						5½			
324JM	14½	14 ⁴¹ / ₁₀₀	14	8	6¼	5¼	1/16	69/100	17 ²⁷ / ₃₂
326JM						6			
364TCZ	17	18 ³ / ₅₀	15	9	7	5 ⁵ / ₈	7/8		19½

364TCZ and 365TCZ frames are built with 326JM shaft extensions. Dimensions may vary with manufacturer.

Motor Frame Selections

Frame	Motor Horsepower						Wt. Max.
	3500 RPM		1750 RPM				
	3 PH	1 PH	3 PH	1 PH	3 PH	1 PH	
	ODP*	TEFC*	ODP*	TEFC*	ODP*	TEFC*	
145JM	-	-	-	-	2	2	57
182JM	-	-	2	2, 3	3	3	77
184JM	-	-	3	-	5	5	97
213JM	10	-	5	-	7½	7½	141
215JM	15	10	-	-	10	10	155
254JM	20	15	-	-	15	15	265
256JM	25	20	-	-	20	20	320
284JM	30	25	-	-	25	25	419
286JM	40	30	-	-	-	-	422
324JM	50	40	-	-	-	-	562
326JM	60	50	-	-	-	-	625
364TCZ	75	60	-	-	-	-	775
365TCZ	100	75, 100	-	-	-	-	905

364TCZ and 365TCZ frames are built with 326JM shaft extensions. * Premium efficiency where required by Department of Energy regulations.

e-SH FRAME MOUNTED S-GROUP - DIMENSIONS AND WEIGHTS

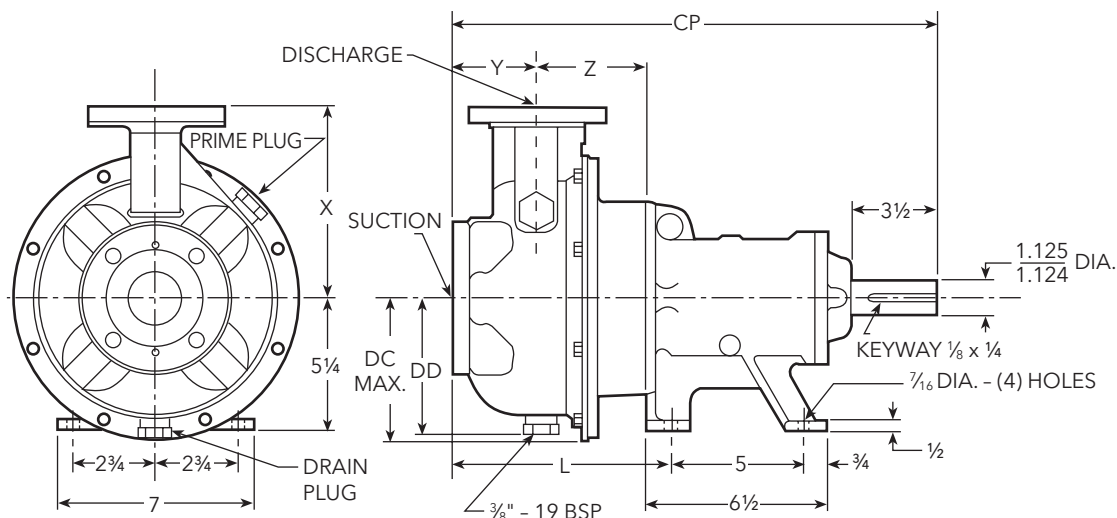

Dimensions and Weights - Bare Pump Only

Pump	Pump Size	150 lb. Flange		DC Max.	DD	CP Max.	L	X	Y	Z	Weight (lbs.)				
		Suction*	Discharge*												
01SH06	1 x 2 - 6	2	1	5	4 3/4	16 3/4	7 7/8	6 3/8	3 3/8	3 3/8	56				
01SH08	1 x 2 - 8			5 5/8	5 3/8			7 7/8			64				
01SH10	1 x 2 - 10			6 7/8	6 5/8			17 1/16			8 3/4	8 7/8	4	86	
15SH06	1 1/2 x 2 1/2 - 6	2 1/2	1 1/2	5	4 3/4	16 5/16	7 3/4	6 3/8	3 1/4	3 3/8	57				
15SH08	1 1/2 x 2 1/2 - 8			5 5/8	5 3/8			7 7/8			65				
02SH06	2 x 2 1/2 - 6		2	2	5			4 3/4			17 5/16	8 1/2	4	3 3/8	57
02SH08	2 x 2 1/2 - 8				6			5 3/4							7 15/16
25SH06	2 1/2 x 3 - 6	3	2 1/2								59				

* For use with ANSI class 150 mating flanges.

NOTE:

- Pumps will be shipped with top vertical discharge as standard. For other orientations, remove casing bolts, rotate discharge to desired position, and tighten 3/8"-16 bolts to 20 ft./lbs., 7/16" - 14 bolts to 20 ft./lbs.
- ALL dimensions in inches.
- Not for construction purposes.

e-SH S-GROUP ENGINEERING DATA

Channel Steel Bedplate, Clockwise Rotation Viewed from Drive End

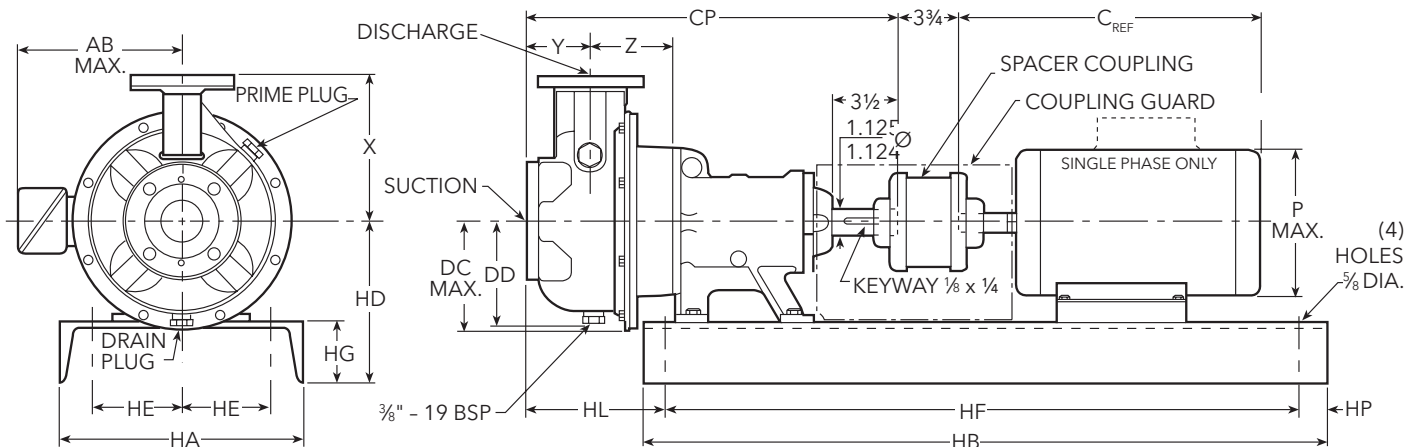

Dimensions and Weights - Determined by Pump

Pump	Suction*	Discharge*	CP	DC Max.	DD	X	Y	Z	Wt. (lbs.)	Dimension "HL" Determined by Pump and Bedplate				
										Motor Frame Size				
										143/145	183/184	213/215	254/256	284/286
01SH06	1 X 2-6	2	1	16 3/4	5	4 3/4	6 3/8	3 3/8	3 3/8	56	9 1/8	7 3/8	3 3/8	
01SH08	1 X 2-8			5 5/8	5 5/8	7 1/8	4	3 5/8						64
01SH10	1 X 2-10			17 1/16	6 7/8	6 5/8								
15SH06	1 1/2 X 2 1/2-6	2 1/2	1 1/2	16 5/16	5	4 3/4	6 3/8	3 1/4	3 5/8	57	9 1/4	7 3/4	4	
15SH08	1 1/2 X 2 1/2-8			5 5/8	5 3/8	7 1/8	4	3 5/8						66
02SH06	2 X 2 1/2-6			17 1/16	5	4 3/4								
02SH08	2 X 2 1/2-8	6	5 3/4	7 15/16	68									
25SH06	2 1/2 X 3-6	3	2 1/2							59				

* For use with ANSI Class 150 mating flanges.

NOTES:

1. All pumps shipped in vertical discharge position. May be rotated in 90° increments. Tighten 3/8" - 16 casing bolts to 20 ft./lbs. torque.
2. Dimensions in inches.
3. Motor dimensions may vary with motor manufacturer.
4. Not to be used for construction purposes.

Available Motor and Bedplate Dimensions and Weights

Motor Frame	HP @ 3500 RPM				HP @ 1750 RPM				AB Max.	C _{REF}	P Max.	Wt. Max.	Bedplate Data									
	1 PH		3 PH		1 PH		3 PH						HA	HB	HD**	HE	HF	HG	HP*	Wt. (lbs.)	Motor Shim	Bearing Frame Shim
	ODP***	TEFC***	ODP***	TEFC***	ODP***	TEFC***	ODP***	TEFC***														
143T					1	1	1	1	5 1/4	13 3/8	6 5/8	45	10	28	8	3 3/4	24	2 3/4	3/4	48	1 3/4	-
145T	2	2	2-3	2	1 1/2	1 1/2	1 1/2-2	1 1/2-2	14 1/4	53												
182T	3	3	5	3	2	2	3	3	16 5/8	74												
184T	5	5	7 1/2	5	3 or 5	3	5	3	5 7/8	18 1/8	95	3/4										
213T			10	7 1/2					7 3/8	18	9 5/8	116	12	31	8 1/4	4 1/4	29	3	1	65	-	-
215T			15	10					19 1/8	136												
254T			20	15					10 5/8	21 5/8	13	266	13	42	10 1/4	5 1/4	38 1/2	4	1 3/4	110	-	1
256T			25	20					23 3/8	264												
284TS			30	25					12 5/8	24 7/8	15	392	15	44	10 1/2	5 3/4	40 1/2	3 1/2	1 3/4	124	-	1 3/4
286TS			40	30					26 5/8	432												

Dimensions and weights vary with manufacturers. Dimensions in inches and weights in lbs.

* "HP" Dimensions at motor end only.

** "HD" Dimension for 254T/256T motor frame on 1 x 2-10 only is 11"; A 3/4" motor shim and a 1 3/4" bearing frame shim are required.

*** Premium efficiency where required by Department of Energy regulations.

e-SH FRAME MOUNTED M-GROUP - DIMENSIONS AND WEIGHTS

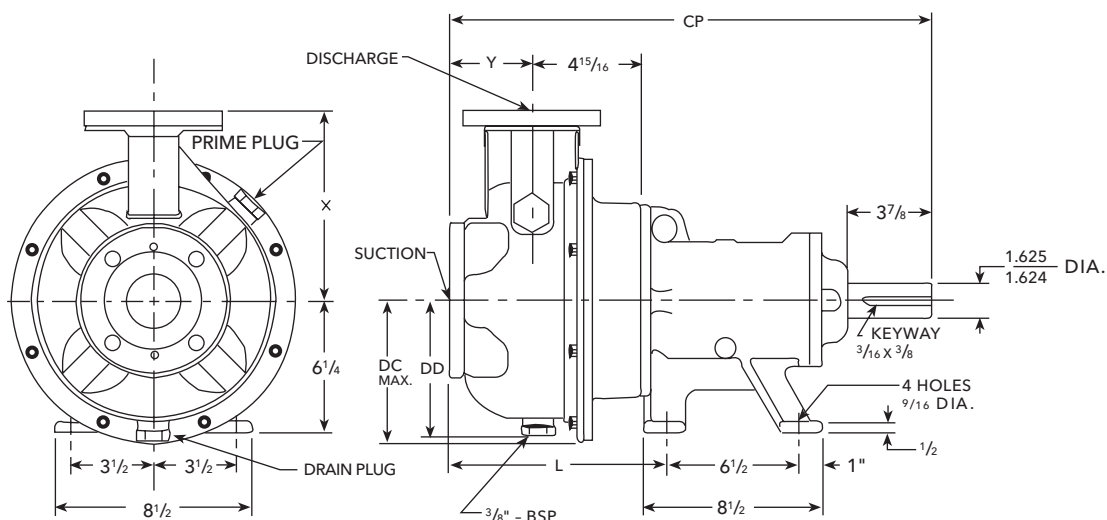

Dimensions and Weights - Bare Pump Only

Pump	Pump Size	Suction*	Discharge*	CP	DC Max.	DD	L	X	Y	Weight (lbs.)
15SH10	1½ x 2½-10	2½	1½	23	6⅞	6⅝	10¼	8½⅙	4	125
02SH10	2 x 2½-10		2							125
25SH08	2½ x 3-8	3	2½		6⅞	5⅞				125
25SH10	2½ x 3-10				6⅞	6⅝				134
03SH08	3 x 4-8	4	3	24	7⅞	7⅞	11¼	11⅝	5	136
03SH10	3 x 4-10									148

* For use with ANSI class 150 mating flanges.

NOTES:

- Pumps will be shipped with top vertical discharge as standard.
For other orientations, remove casing bolts, rotate discharge to desired position, replace and tighten
⅜ - 16 bolts to 20 ft./lbs., ½ - 13 bolts to 40 ft./lbs.
- Motor dimensions may vary with motor manufacturer.
- Not for construction purposes.

e-SH M-GROUP ENGINEERING DATA

Channel Steel Bedplate, Clockwise Rotation Viewed from Drive End

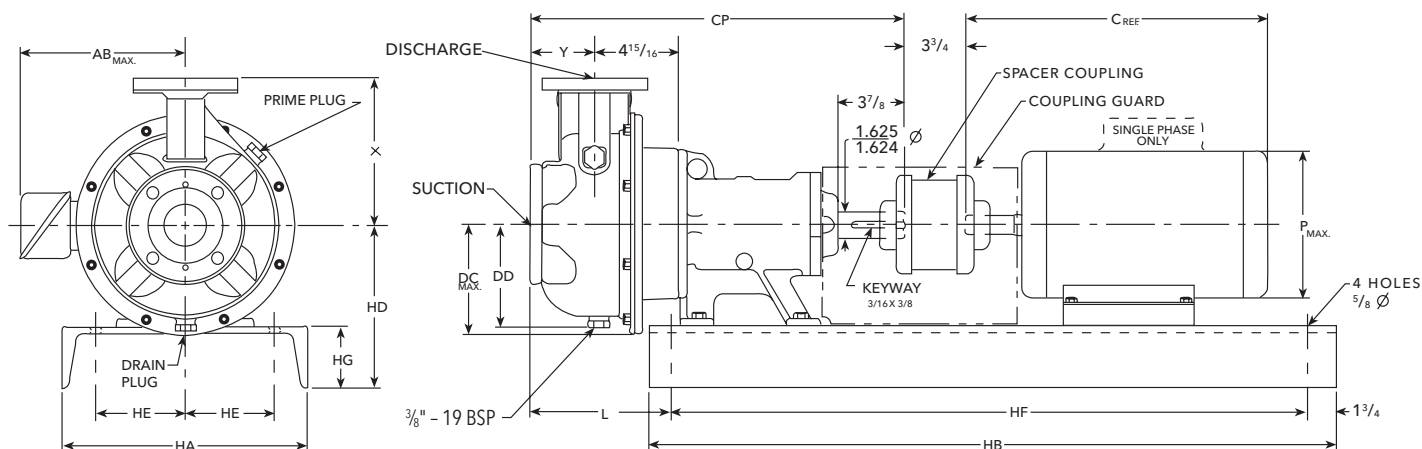

Dimensions and Weights - Determined by Pump

Pump	Pump Size	Suction*	Discharge*	CP	DC Max.	DD	L	X	Y	Weight (lbs.)	
15SH10	1½ x 2½-10	2½	1½	23	6⅞	6⅝	10⅞	8 ¹⁵ / ₁₆	4	125	
02SH10	2 x 2½-10		2		6⅞	6⅝				125	
25SH08	2½ x 3-8	3	2½		6⅞	5⅞		11⅞		9 ¹⁵ / ₁₆	125
25SH10	2½ x 3-10				6⅞	6⅝					134
03SH08	3 x 4-8	4	3		24	7⅞	7⅞	11⅞	11⅞	5	136
03SH10	3 x 4-10					7⅞	7⅞			148	

NOTE:

1. Pumps will be shipped with top vertical discharge as standard. For other orientations, remove casing bolts, rotate discharge to desired position and tighten ¾ - 16 bolts to 20 ft./lbs., ½ - 13 bolts to 40 ft./lbs.
2. ALL dimensions in inches.
3. Not for construction purposes.

* For use with ANSI class 150 mating flanges

Available Motor and Bedplate Dimensions and Weights

Motor Frame	HP @ 3500 RPM		HP @ 1750 RPM - T-Frame Only				AB Max.	C _{REF.}	P Max.	Wt. Max.	Bedplate Data						
	3 PH		1 PH		3 PH						HA	HB	HD	HE	HF	HG	Wt. (lbs.)
	ODP	TEFC	ODP	TEFC	ODP	TEFC											
184T			3 or 5	3	5	5	5⅞	18⅞	7⅞	95	13	42	10¼	5¼	38½	4	111
213T					7½	7½	7⅞	18	116								
215T	15				10	10	7⅞	19⅞	9⅝	136							
254T	20	15			15	15	9⅞	21 ⁵ / ₈	13	266	15	44	10½	5¾	40½	3½	124
256T	25	20			20	20	9⅞	23 ³ / ₈		264							
284TS/T	30	25			25	25	12⅝	24 ⁷ / ₈	15	392							
286TS/T	40	30					12⅝	26 ⁵ / ₈	15	422							
324TS/T	50	40					14⅞	28¾	17⅝	592	18	48	12	7¼	44½	4	183
326TS/T	60	50					14⅞	30¼		634							
364TS/T	75	60					15⅞	31 ⁵ / ₈	18⅞	834							
365TS/T	100	75					15⅞	32 ⁵ / ₈		1000							
405TS/T		100					18	36 ³ / ₈	20⅝	1060	22	56	14	7¼	52½	4	214

Dimensions and weights vary with manufacturers. Dimensions in inches and weights in lbs.

NAMEPLATE

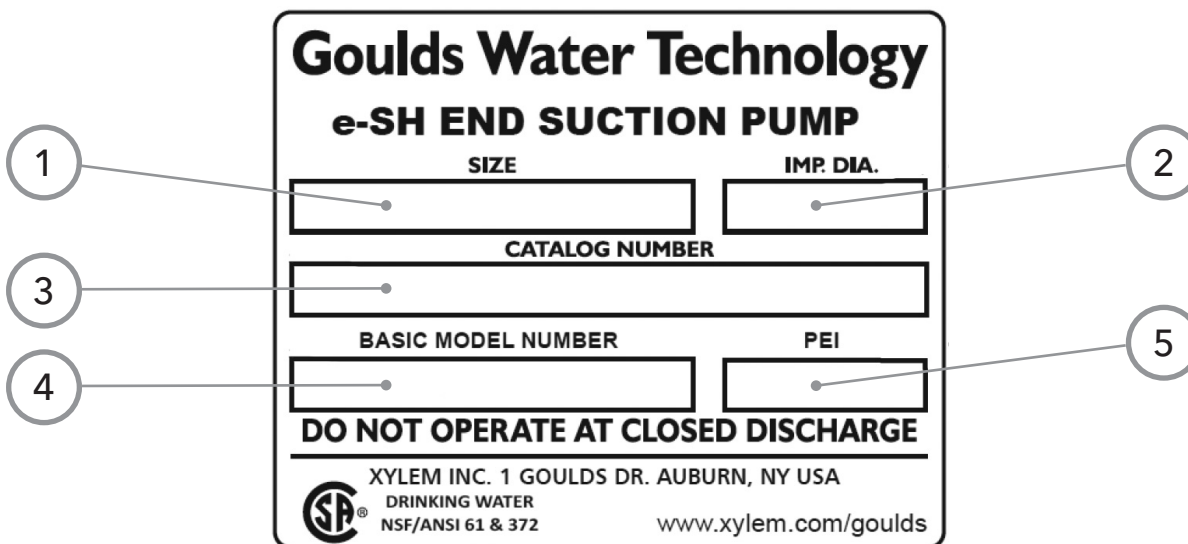

LEGEND

1. Pump size
2. Impeller trim
3. Pump Identification Code (per existing nomenclature)
4. Basic Model Number (per DOE definition)
5. Pump Energy Index

MECHANICAL SEALS

List of Materials

Materials				Part No.	
Rotary Ring	Stationary Ring	Elastomers	Metal Parts	180-210 Frames	250-360 Frames
Carbon	SiI-Carb	FKM	316SS	10K27	10K45
		EPR		10K19	10K20
SiI-Carb		FKM		10K64	10K65

***Note:** for limits and recommendations of each combination of materials, contact factory.

TECHNICAL APPENDIX

NOZZLE LOADING

When the applied loads do not attain the maximum values allowed, one of these loads may exceed the normal limit, provided the following supplementary conditions are satisfied:

- any component of a force or of a moment shall be limited to 1.4 times the maximum allowable value;
- the actual forces and moments acting on each flange meet the condition:

$$\left(\frac{\sum |F_{x,y,z}|}{\sum |F_{max}|} \right)^2 + \left(\frac{\sum |M_{x,y,z}|}{\sum |M_{max}|} \right)^2 \leq 2$$

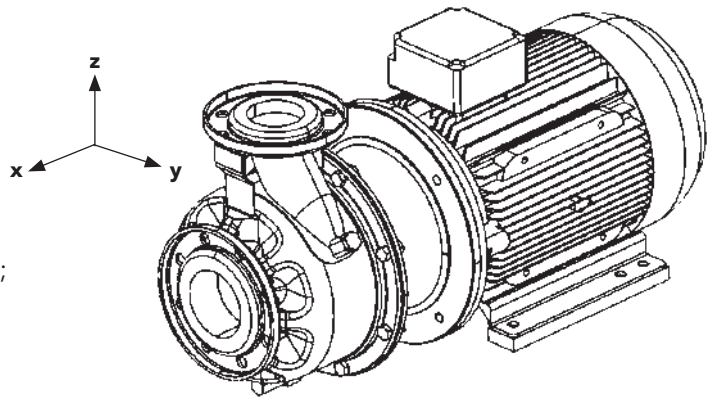

Size	Suction									Discharge								
	Size	Fx max [lbf]	Fy max [lbf]	Fz max [lbf]	ΣF max [lbf]	Mx max [lbf·ft]	My max [lbf·ft]	Mz max [lbf·ft]	ΣM max [lbf·ft]	Size	Fx max [lbf]	Fy max [lbf]	Fz max [lbf]	ΣF max [lbf]	Mx max [lbf·ft]	My max [lbf·ft]	Mz max [lbf·ft]	ΣM max [lbf·ft]
01SH06	2"	93	84	76	147	258	184	212	381	1"	31	28	35	55	120	83	97	176
01SH08																		
01SH10																		
15SH06	2.5"	117	105	96	184	277	198	226	409	1.5"	49	45	56	87	192	133	155	280
15SH08																		
15SH10																		
02SH06	2.5"	117	105	96	184	277	198	226	409	2"	67	61	74	117	207	148	170	305
02SH08																		
02SH10																		
25SH06	3"	141	127	115	221	295	212	240	435	2.5"	84	76	93	147	221	159	181	327
25SH08																		
25SH10																		
03SH08	4"	188	169	152	295	323	231	268	478	3"	101	92	112	177	236	170	192	348
03SH10																		



Xylem Inc.
 2881 East Bayard Street Ext., Suite A
 Seneca Falls, NY 13148
 Phone: (866) 673-0428
 Fax: (888) 322-5877
www.xylem.com/goulds

Goulds is a registered trademark of Goulds Pumps, Inc. and is used under license.
 Intellitronic X is trademark or registered trademark of Xylem Inc. or one of its subsidiaries.
 All other trademarks or registered trademarks are property of their respective owners.
 © 2021 Xylem Inc. BeSH R2 September 2021