

1100 SERIES

1103/LE51M (B10)

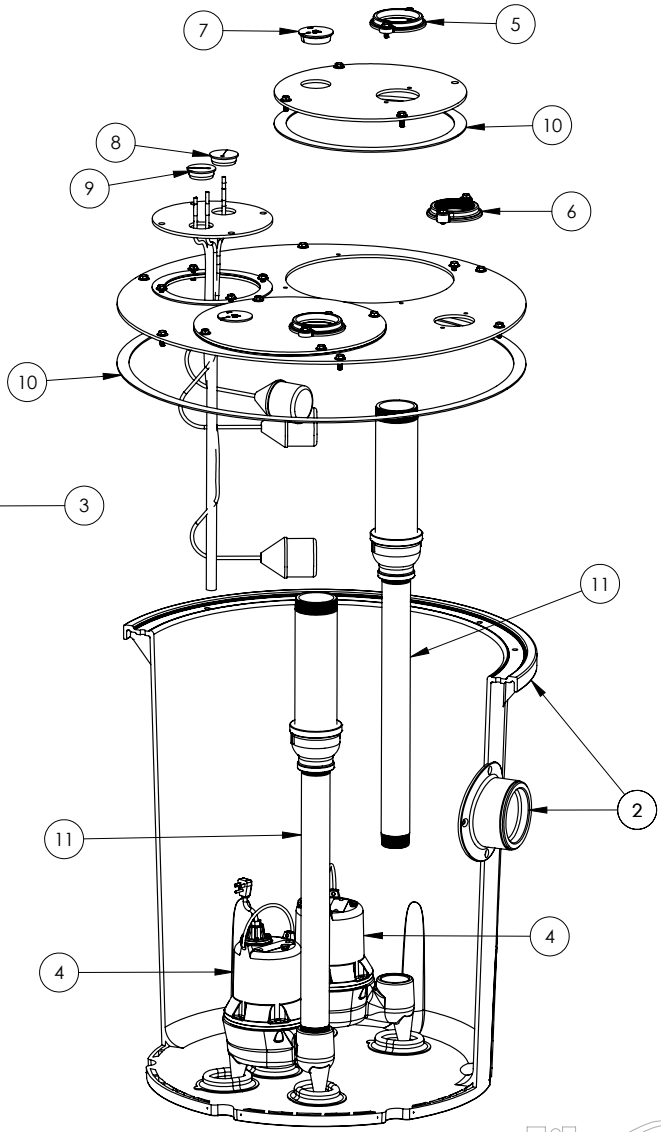
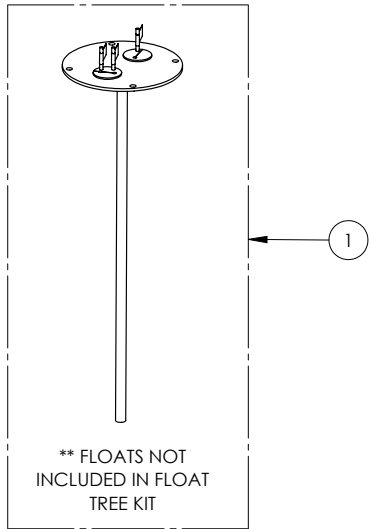
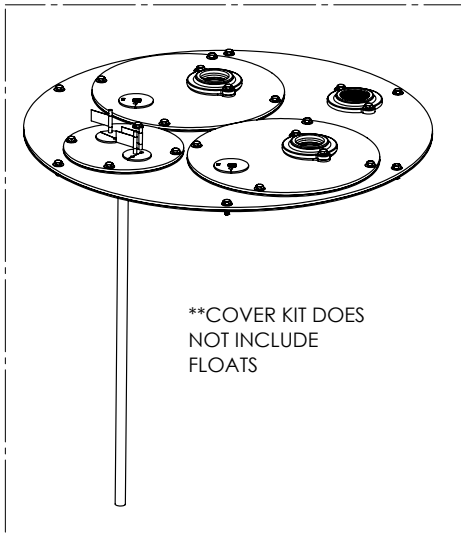

1100 SERIES**1103/LE51M (B10)**

#	PART #	DESCRIPTION	QTY	Note
1	K001203	10" INSPECTION COVER WITH FLOAT TREE (FLOATS NOT INCLUDED)	1	
2	K001202	30" X 36" BASIN, WITH CAST IRON INLET HUB	1	
3	K001201	1100 COVER KIT 3" DISCH 3" VENT	1	
4	LE51M	1/2 HP SEWAGE PUMP 115V, 10' POWER CORD	2	
5	K001391	3" DISCHARGE FLANGE KIT	2	
6	K001392	3" VENT FLANGE KIT	1	
7	4508000	2 1/2" STOPPER - SINGLE 5/16" HOLE	2	
8	45480A0	SINGLE HOLE STOPPER	1	
9	45480B0	2" DOUBLE HOLE STOPPER	1	
10	45220C0	GASKET TAPE	1	
11	50990A0	PIPE ASSEMBLY 2X3" 1100/700	2	

1103/LE51M (B10)

1103-LE51M_B10-A

PAGE