

XFL54M-2 (B90)

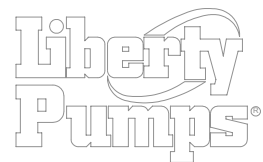
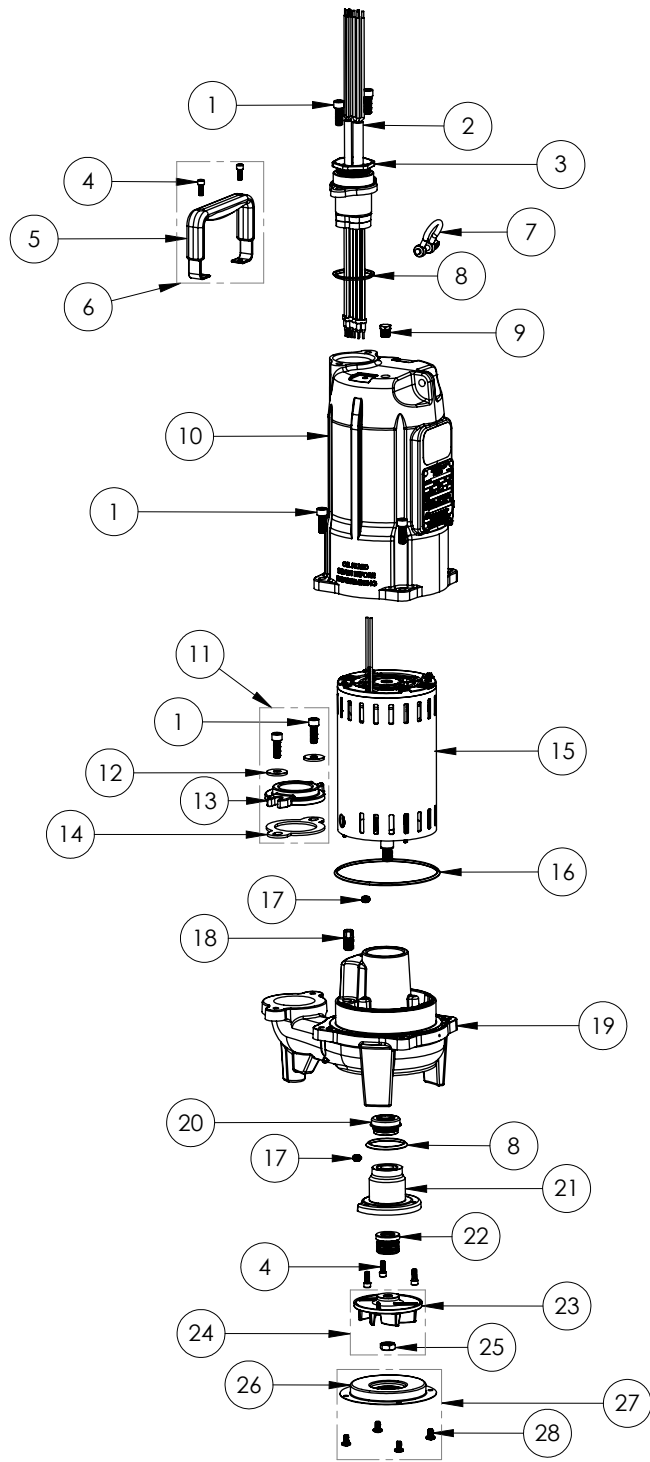

**XFL54M-2****XFL54M-2 (B90)**

#	PART #	DESCRIPTION	QTY	Note
1	5862000	BOLT, 3/8-16X1 SHCS SS	8	
2	34740D0	CORD CAP 25' WITH JUMPER, 4 CONDUCTOR	1	[1]
3	3467000	1-1/2" NPT THREADED BUSHING	1	[1]
4	8103000	SCREW 1/4-20x5/8" HX SKT SS	5	
5	3411200	HANDLE	1	
6	K001681	HANDLE KIT WITH BOLTS	1	
7	K001680	SHACKLE KIT	1	
8	3428000	O-RING ASTM 568A- 226	2	
9	50710A0	PIPE PLUG, 1/4" HEX HD BRASS NPTF	1	
10	341600R	HOUSING XFL/XLE PAINTED	1	[1]
11	K001421	1.5" DISCHARGE ADAPTER, INCLUDES HARDWARE AND GASKET	1	
12	8158000	WASHER, 3/8 x 1-1/8, SS	2	
13	586100R	1.5" ADAPTER FLANGE	1	
14	5858000	1.5" FLANGE GASKET	1	
15	34240A0	MOTOR 2-POLE, 3PH, 208/230V 440/480V, 60Hz	1	[1]
16	3403000	O-RING	1	
17	34470A0	1/8" STAINLESS STEEL OIL PLUG 18-8	2	
18	3450000	SEAL FAIL PROBE BODY	1	
19	341500R	XFL VOLUTE PAINTED	1	[1]
20	5633000	3/4" UNITIZED SHAFT SEAL	1	[2]
21	3427000	SEAL PLATE WITH BUSHING	1	[1]
22	3429000	SEAL TYPE 2100 18MM	1	[1]
23	34200B0	FLX50 IMPELLER	1	
24	K001684	XFL50 IMPELLER KIT WITH 1/2" NUT	1	
25	8046000	1/2-20 HEX STAINLESS STEEL JAM NUT	1	
26	2902000	STAMPING, INLET	1	
27	K001683	INLET PLATE KIT WITH 1/4" SCREWS	1	
28	3470000	1/4-20X7/16 PPHMS 18-8	4	

**PART NOTES:**

- [1] - WARNING! These motors are listed for application in Class 1, Division 1, Groups C D, EXPLOSION PROOF environments. The pump must be serviced at the factory or a qualified hazardous motor enclosure repair facility approved by Liberty Pumps. Any unauthorized field repairs voidswarranty and hazardous location ratings. Contact Liberty Pumps at 1-800-543-2550 to locate the closest repair facility.
- [2] - Part requires factory authorized service. Contact Liberty Pumps at 1-800-543-2550

WARNING! These motors are listed for application in Class 1, Division 1, Groups C D, EXPLOSION PROOF environments. The pump must be serviced at the factory or a qualified hazardous motor enclosure repair facility approved by Liberty Pumps. Any unauthorized field repairs voidswarranty and hazardous location ratings. Contact Liberty Pumps at 1-800-543-2550 to locate the closest repair facility