

P382LE51V (B10)

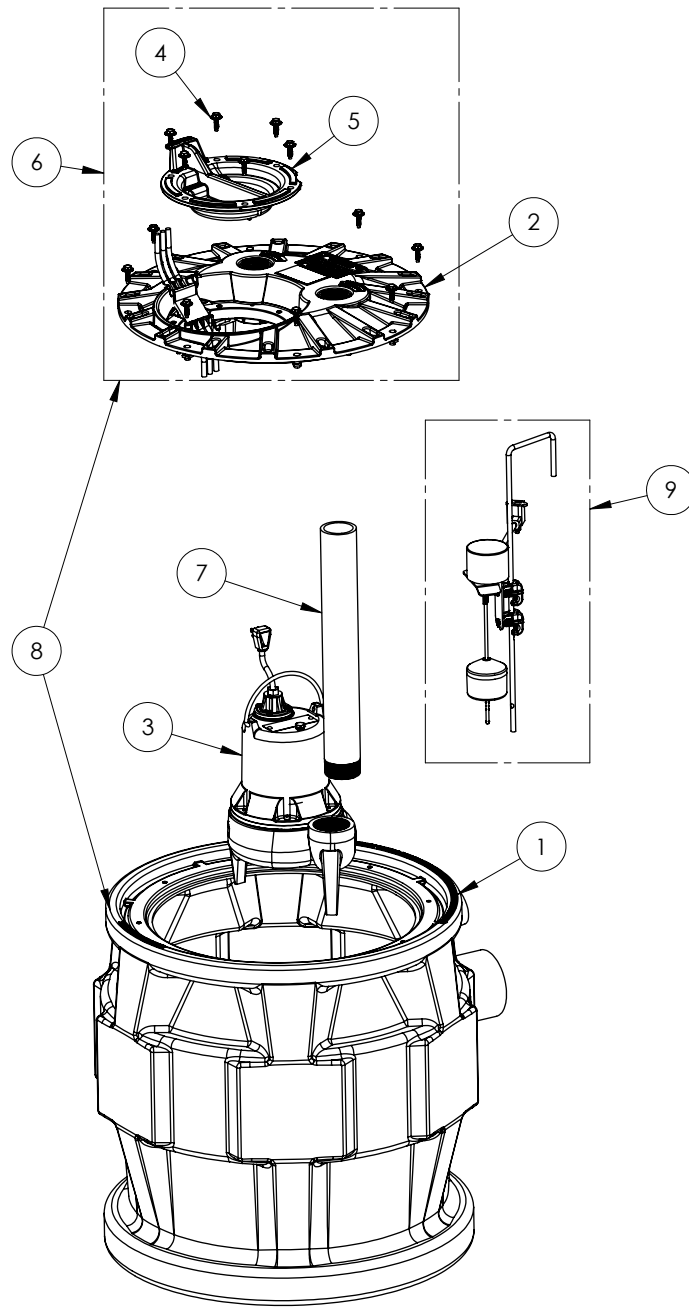

P382LE51V

P382LE51V (B10)

#	PART #	DESCRIPTION	QTY	Note
1	K001110	PRO380 SERIES 24" BASIN	1	
2	50340A0	2X2 COVER, 8 BOLTS, FOR PVC PIPE	1	
3	LE51M	1/2 HP SEWAGE PUMP 115V, 10' POWER CORD	1	
4	K001162	COVER HARDWARE, WASHER HEAD HEX SCREWS 14 INCLUDED IN KIT	1	
5	K001233	INSPECTION COVER, INCLUDES MOUNTING SCREWS (6)	1	
6	K001101	COVER ASY 2X2, 8 BOLTS, FOR PVC PIPE	1	
7	K001399	PRO SERIES PIPE KIT 2" SCH80 X17.50"	1	
8	K001107	P382 TANK & 2X2 COVER ASSEMBLY	1	
9	K001546	380 FLOAT SWITCH ASSEMBLY VRT	1	