



Product information presented here reflects conditions at time of publication. Consult factory regarding discrepancies or inconsistencies.

Register your
Zoeller Pump Company
Product on our website:
<http://reg.zoellerpumps.com/>

MAIL TO: P.O. BOX 16347 • Louisville, KY 40256-0347
SHIP TO: 3649 Cane Run Road • Louisville, KY 40211-1961
TEL: (502) 778-2731 • 1 (800) 928-PUMP • **FAX:** (502) 774-3624

Visit our web site:
zoellerpumps.com

Potable Water Convertible Jet Pumps

OWNER'S MANUAL

Congratulations on the purchase of the Zoeller Potable Water Convertible Jet Pump. Since 1939 the name Zoeller has represented the standard for submersible sump and sewage pumps. The same high-quality workmanship and easy maintenance design has been incorporated into this line of potable water products. This Zoeller system will provide years of trouble-free service when installed according to the manufacturer recommendations.

This manual incorporates the installation, operation, maintenance, and service instructions into one document to aid in the ownership of a Zoeller potable water product. Please read and review this manual before installing the product. Many items contained within, when followed correctly, will not only ensure a long and problem-free life for the system, but also save time and money during installation. Should further assistance be necessary please call our Technical Service department at 1-800-928-PUMP.

P/N 023072

Table of Contents

Safety Instructions.....	1
Limited Warranty.....	2
Preinstallation Information.....	2-3
Installation Procedures	4-7
Parts List.....	7
Troubleshooting Checklist	8

Owner's Information

Model Number: _____ **Date Code:** _____

Job Name: _____

Dealer: _____

Date of Purchase: _____

Contractor: _____

Date of Installation: _____

System Readings During Operation: Voltage _____ Amps _____

Safety Instructions

TO AVOID SERIOUS OR FATAL PERSONAL INJURY OR MAJOR PROPERTY DAMAGE, READ AND FOLLOW ALL SAFETY INSTRUCTIONS IN MANUAL AND ON PUMP.

THIS MANUAL IS INTENDED TO ASSIST IN THE INSTALLATION AND OPERATION OF THIS UNIT AND MUST BE KEPT WITH THE PUMP.



This is a **SAFETY ALERT SYMBOL**.

When you see this symbol on the pump or in the manual, look for one of the following signal words and be alert to the potential for personal injury or property damage.

▲ DANGER Warns of hazards that **WILL** cause serious personal injury, death or major property damage.

▲ WARNING Warns of hazards that **CAN** cause serious personal injury, death or major property damage.

▲ CAUTION Warns of hazards that **CAN** cause personal injury or property damage.

▲ NOTICE Indicates special instructions which are very important and must be followed.

THOROUGHLY REVIEW ALL INSTRUCTIONS AND WARNINGS PRIOR TO PERFORMING ANY WORK ON THIS PUMP.

MAINTAIN ALL SAFETY DECALS.

LIMITED WARRANTY

Manufacturer warrants, to the purchaser and subsequent owner during the warranty period, every new product to be free from defects in material and workmanship under normal use and service, when properly used and maintained, for a period of one year from date of purchase by the end user, or 18 months from date of original manufacture of the product, whichever comes first. Parts that fail within the warranty period, one year from date of purchase by the end user, or 18 months from the date of original manufacture of the product, whichever comes first, that inspections determine to be defective in material or workmanship, will be repaired, replaced or remanufactured at Manufacturer's option, provided however, that by so doing we will not be obligated to replace an entire assembly, the entire mechanism or the complete unit. No allowance will be made for shipping charges, damages, labor or other charges that may occur due to product failure, repair or replacement.

This warranty does not apply to and there shall be no warranty for any material or product that has been disassembled without prior approval of Manufacturer, subjected to misuse, misapplication, neglect, alteration, accident or act of nature; that has not been installed, operated or maintained in accordance with Manufacturer's installation instructions; that has been exposed to outside substances including but not limited to the following: sand, gravel, cement, mud, tar, hydrocarbons, hydrocarbon derivatives (oil, gasoline, solvents, etc.), or other abrasive or corrosive substances, wash towels or feminine sanitary products,

etc. in all applications. The warranty set out in the paragraph above is in lieu of all other warranties expressed or implied; and we do not authorize any representative or other person to assume for us any other liability in connection with our products.







Contact Manufacturer at, 3649 Cane Run Road, Louisville, Kentucky 40211, Attention: Customer Support Department to obtain any needed repair or replacement of part(s) or additional information pertaining to our warranty.

MANUFACTURER EXPRESSLY DISCLAIMS LIABILITY FOR SPECIAL, CONSEQUENTIAL OR INCIDENTAL DAMAGES OR BREACH OF EXPRESSED OR IMPLIED WARRANTY; AND ANY IMPLIED WARRANTY OF FITNESS FOR A PARTICULAR PURPOSE AND OF MERCHANTABILITY SHALL BE LIMITED TO THE DURATION OF THE EXPRESSED WARRANTY.

Some states do not allow limitations on the duration of an implied warranty, so the above limitation may not apply to you. Some states do not allow the exclusion or limitation of incidental or consequential damages, so the above limitation or exclusion may not apply to you.

This warranty gives you specific legal rights and you may also have other rights which vary from state to state.

PREINSTALLATION INFORMATION

- 1. Inspect your unit.** Occasionally, products are damaged during shipment. If the unit is damaged, contact your dealer before using.
- 2. Carefully read the literature** provided to familiarize yourself with specific details regarding installation and use. These materials should be retained for future reference.
-  **▲ WARNING** Do not lift, carry, or hang pump by the electrical cables. Damage to the electrical cables can cause shock, burns or death.
-  **▲ WARNING** **Make sure the pump electrical supply circuit is equipped with fuses or circuit breakers of proper capacity.** A separate branch circuit is recommended, and sized according to the "National Electrical Code" for the current shown on the pump nameplate.
-  **▲ WARNING** Pump is designed to pump cold ground water that is free of air or gases. Decreased pump performance and life expectancy can occur if the ground water is not cold (86 °F/30 °C) or contains air or gases.
-  **▲ WARNING** **DO NOT** run the pump dry. **DO NOT** run the pump with a completely closed discharge. **DO NOT** pump chemical or corrosive liquids. Failure to follow above warnings could result in damage to the pump, voiding the warranty and causing personal injury.
-  **▲ CAUTION** Check to be sure your power source is capable of handling the voltage requirements of the motor, as indicated on the pump nameplate.
-  **▲ CAUTION** Water hammer creates momentary high pressure surges. These surges can cause severe damage to check valves and the piping system. Consideration for water hammer must be included in the piping system design. Reference ASPE Data Book, Chapter 2.33. Some systems may require external spring or lever weighted check valves or other engineered solutions.
-  **▲ WARNING** Prop65 Warning for California residents: Cancer and Reproductive Harm- www.P65warnings.ca.gov.

SAFETY INFORMATION

DANGER:

1. Always disconnect power source before performing any work on or near the motor or its connected load. If the power disconnect point is out-of-sight, lock it in the open position and tag it to prevent unexpected application of power. Failure to do so could result in fatal electrical shock.
2. Do not handle the pump with wet hands or when standing in water as fatal electrical shock could occur. Disconnect main power before handling unit for ANY REASON!
3. RISK OF ELECTRIC SHOCK. These pumps have not been investigated for use in swimming pool areas.

WARNING:

1. Follow all local electrical and safety codes, as well as the National Electrical Code (NEC) and the Occupational Safety and Health Act (OSHA).
2. Replace damaged or worn wiring cord immediately.
3. Do not kink power cable and never allow the cable to come in contact with oil, grease, hot surfaces, or chemicals.
4. Wire motor to correct supply voltage - see motor nameplate and wiring diagrams and check voltage of power supply.
5. Unit must be securely and adequately electrically grounded. This can be accomplished by wiring the unit to a ground metal-clad raceway system or by using a separate ground wire connected to the bare metal of the motor frame or other suitable means.

6. Hazardous Pressure! Install pressure relief valve in discharge pipe. Release all pressure on system before working on any component.
7. Do not use to pump flammable or explosive fluids such as gasoline, fuel oil, kerosene, etc. Do not use in flammable and/or explosive atmospheres.

CAUTION:

1. Protect the power cable from coming in contact with sharp objects.
2. Be careful when touching the exterior of an operating motor - It may be hot enough to be painful or cause injury.
3. Make certain that the power source conforms to the requirements of your equipment.
4. Do not run pump dry.
5. Pump and plumbing must be full of water before startup.
6. Do not pump water which contains sand, mud, silt, or debris

NOTE: Pumps with the "UL" Mark and pumps with the "US" mark are tested to UL Standard UL778. CSA certified pumps are certified to CSA Standard C22.2 No. 108. (CUS)

MOTOR DATA CHART

HP	Phase	Volts	Code Letter	Max Amps	Locked Rotor Amps
1/2	1	115 or 230	K	13.0/6.5	36.0/18.0
1	1	115 or 230	L	18.0/9.0	78.0/39.0

IMPORTANT:

This jet pump is wired for either 115V or 230V. The label on the pump will state whether pump is pre-wired for 115V or 230V. To change pump voltage, see pump label diagram.

READ THESE INSTRUCTIONS CAREFULLY BEFORE INSTALLATION

LOCATION

1. Pump can be located at the well or can be offset some distance away from the well. For best performance it should be located as close to the well as possible. The horizontal distance is the horizontal measurement between pump suction and the water source. This distance may affect the ability of the pump to operate. If over 100', contact the Manufacturer for assistance.
2. Location can be in the basement, a pit below ground or in a pump house above ground.
3. Ventilation and drainage must be provided to prevent damage from moisture to the motor and pressure switch.
4. The pump and all piping must be protected from freezing.
5. Pump and pipe line must be drained when not in use if there is any danger of freezing.

WELL CONDITIONS

1. New wells should be pumped clean of all sand and foreign matter before installing the pump or damage may result to the operating parts.
2. The foot valve should be installed a minimum of five (5) feet from the bottom of the well to prevent sand, mud or other foreign matter from entering the system.
3. The well must be capable of furnishing a sufficient quantity of water to satisfy the demands of the pump and personal needs. The water level must not draw down below the maximum rated depth of the pump or loss of capacity and prime will result.
4. For weak well installations, see Paragraph #1 under Deep Well (Double Pipe System) Installations (Page 5).
5. For sanitary reasons, install a well seal or pitless adapter as required and in accordance with local and state codes.

PIPING

1. Old or badly scaled pipe should not be used because dislodged flakes of scale can cause stoppage of the ejector nozzle and malfunction the entire system.
2. Use only pipe in good condition free from rust and scale. Threads should be sharp, cleanly cut with a minimum of two (2) threads remaining when connection is completely drawn up.
3. On galvanized steel pipe installations, the ends should be reamed to insure maximum capacity.
4. All joints and connections should be doped (male threads only) and drawn up tightly.

⚠ CAUTION The entire system must be air and water tight for efficient operation.

TYPE OF PIPE

1. Plastic or galvanized steel pipe may be used in the installation of jet pumps.
2. Plastic pipe must have a minimum pressure rating of 160 PSI.
3. Never use flexible plastic pipe and insert adapters on deep well single pipe ejector applications.

WELL TO PUMP PIPING

1. All offset piping should slope upwards from well to pump.
2. Avoid dips or pockets in offset piping or air will accumulate at high points which will make priming difficult.
3. Install unions at pump and at well to aid in servicing.
4. Allow enough room around pump and piping installation for using pipe wrenches and for service and installation.
5. Do not use piping of sizes smaller than those listed in Charts 1 and 2 or pump will not operate properly.

NOTE: For the pump to operate, the venturi tube of the ejector must be positioned into the top tapping of the face of the pump.

CONTROL BODY AND PRESSURE SWITCH ATTACHMENT

1. To assure leak free connections, use Teflon tape or pipe dope on all switch and pipe threads. Tighten all connections by hand plus 1-1/2 additional turns.
2. Use pipe dope on external threads of all plumbing connections.

PREPARATION

Before beginning installation of product, make sure all parts are present. If any part is missing or damaged, do not attempt to assemble the product. Contact customer service for replacement parts.

Estimated Installation Time: 2 hours.

Tools required

Pipe wrenches (2)
Wire strippers
Needle-nose pliers
Phillips screwdriver

Adjustable wrench
Pipe tape
Pipe dope
Wire cutters

NOTE: For a successful installation, take time to study your application for the correct pipe size and appropriate fittings. The illustrations in these instructions will assist you with required and optional fittings. Sch. 40 PVC plastic pipe and fittings were used in these instructions.

Parts You May Need For Assembly not included (Fig. 1)

Item	Description
1	1-1/4 in. union
2	1-14 in. adapter
3	1-1/4 in. elbow
4	3/4 in. union
5	1 in. adapter
6	1 in. x 3/4 in. reducer bushing
7	3/4 in. adapter
8	1 in. elbow
9	1-1/4 in. check valve
10	3/4 in. tee (plastic)
11	3/4 in. tee (steel)
12	3/4 in. x 3 in. nipple (steel)
13	3/4 in. plug (steel)
14	Foot Valve
	Electric cord strain relief

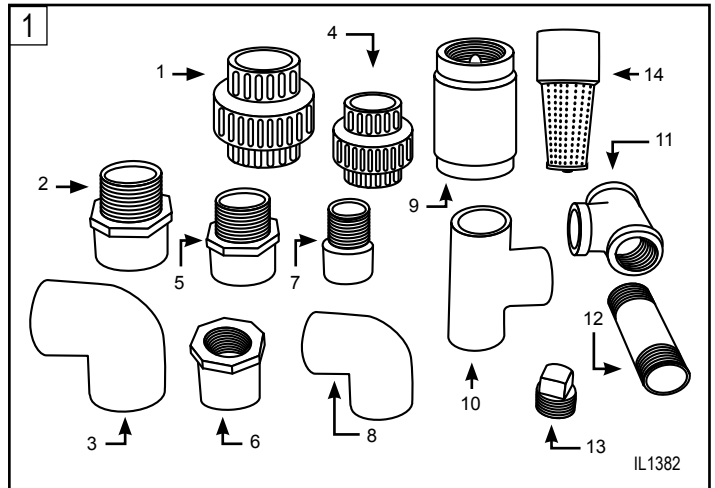

Optional Parts For Assembly not included (Fig. 2)

Item	Description
1	Ball Valve (plastic)
2	3/4 in. x 1/4 in. bushing (steel)
3	Pressure Gauge
4	Pump stand for tank
5	Well adapter for single pipe packer installations (straight and right angle shown)

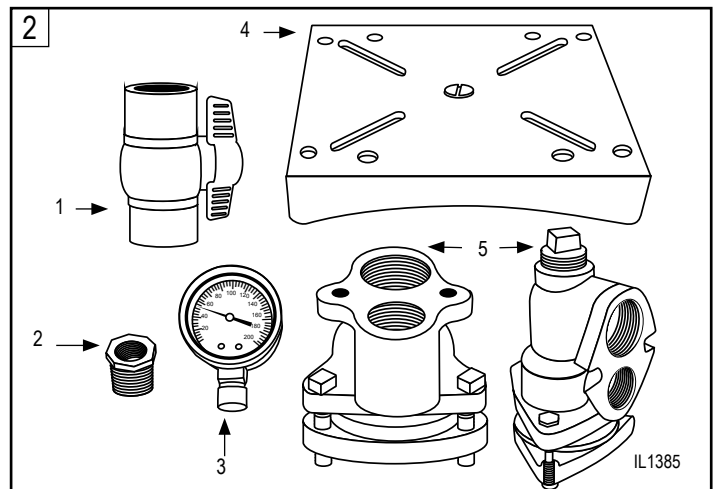

INSTALLING PIPING IN WELL

Shallow Well Application

Where suction lift is less than 25'

1. On single pipe installations (Fig. 1) attach foot valve to the end of the suction pipe and set in the well, making certain the valve is below the water level. The foot valve should be at least five (5) feet from the bottom of the well to prevent sand from being drawn into the system.
2. When connecting a drive point (Fig. 2) a check valve must be used in the suction line in place of a foot valve. For easy priming connect the check valve as close to the well as possible.
3. All piping from the well to the pump should slope slightly upward with no sagging. Support suction pipe between water source and pump. Unions in the suction line near the pump and well will aid in servicing. Be sure to leave enough room so that wrenches can be used easily.

Recommended Suction Pipe Sizes For Shallow Well Pump			
Length Of Offset From Well In Feet			
Motor HP Size	Vertical Piping	0-20'	20-100'
1/2	1"	1"	1-1/4"
1	1-1/4"	1-1/4"	1-1/4"

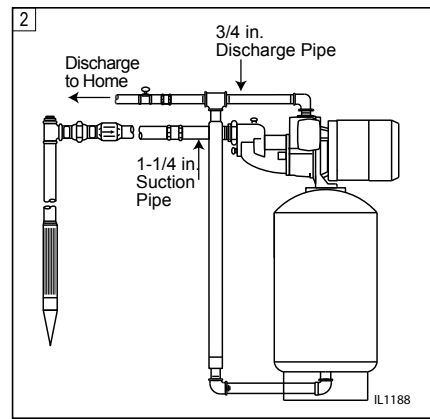
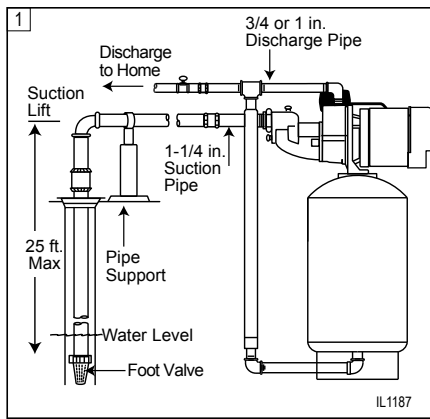

Deep Well (Double Pipe System)

Where water level is greater than 25 feet and inside diameter of well is 4" or larger

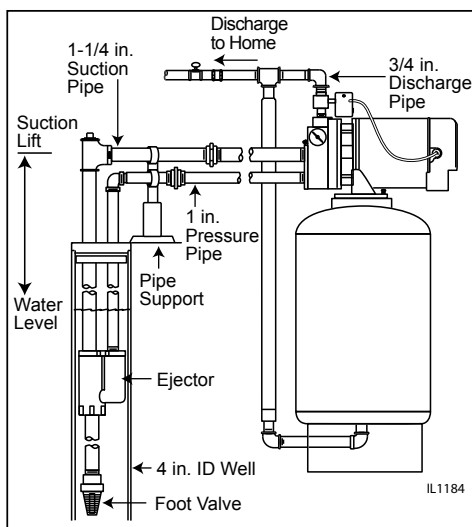

1. Attach the foot valve to the ejector using a galvanized steel or plastic nipple. Add enough 1 in. pressure pipe and 1-1/4 in suction pipe to submerge ejector 10 to 15' below pumping water level, making certain foot valve is at least five (5) feet from bottom of well. If pressure pipe and suction pipe of the same diameter are used, be sure to identify them clearly so that they will be connected to the proper tappings of the pump. If a known well leak exists, replace nipple with 21 feet of 1" tail pipe between the ejector and the foot valve. This will provide a continuous source of water for the pumping system.
2. Check pipe and foot valve for leaks by filling pipes with water. A continuous loss of water indicates a leak in the piping, foot valve or unions, and must be corrected.
3. If no leaks are found, proceed to **WELL TO PUMP CONNECTION (SUCTION PIPE)**. For long offset distances, see chart below for proper pipe size.
4. All piping from the well to the pump should slope slightly upward with no sagging. Support suction pipe between water source and pump. Unions in the suction line near the pump and well will aid in servicing. Be sure to leave enough room so that wrenches can be used easily.

INSTALLING PIPING IN WELL, CONTINUED

Deep Well Application (Single Pipe System)

Where pumping water level is greater than 25 feet and inside diameter of well is 2, 2-1/2 or 3 inches. On single pipe deep well installations, clean, sound well casing must be used to give a tight seal.

NOTE: This application requires a well adapter for the top of the well.

NOTE: Pre-soak packer leathers for approximately two hours before installation.

1. Attach foot valve directly to bottom of ejector assembly. Ejector must be submerged 10 to 15 feet below pumping water level and the foot valve must be at least five (5) feet from bottom of well.
2. Attach foot valve and packer ejector to suction pipe (presoak packer leathers for approximately two (2) hours). Push the assembly down the well. Some force may be required to push the ejector down the casing.
3. As each section is lowered, check for leaks by pouring water into the suction pipe.
4. Attach well adapter to suction pipe, lower over casing top and tighten adapter flange.
5. If no leaks are found, proceed to **WELL TO PUMP CONNECTION (SUCTION PIPE)** using piping of the same diameter as the suction pipe (1-1/4") and pressure pipe (1") tappings of the pump. For long offset distances, see chart on page 9 for the proper pipe size.
6. Unions in suction and discharge piping near pump and well will aid in servicing. Be sure to leave enough surrounding room so that wrenches can be used easily.

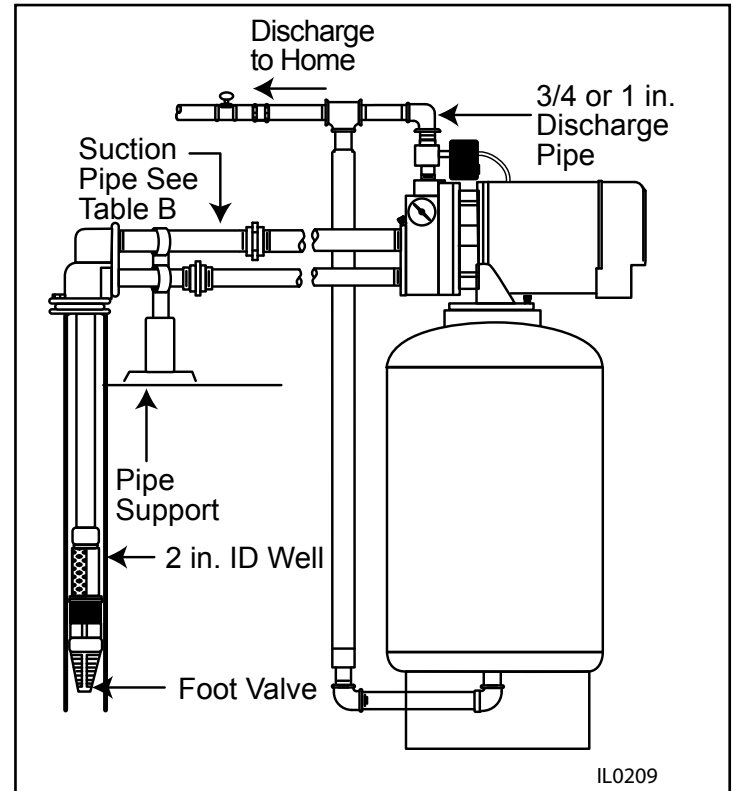

Pipe Sizes Required for Offset Piping for Deep Well Ejector Installation - Table B

Total Suction Pipe Length	1/2 HP Suct	1/2 HP Press	3/4 HP Suct	3/4 HP Press	1 HP Suct	1 HP Press
0 - 25'	1-1/4"	1"	1-1/4"	1"	1-1/4"	1"
25 - 50'	1-1/4"	1-1/4"	1-1/2"	1-1/4"	1-1/2"	1-1/4"
50 - 75'	1-1/4"	1-1/4"	1-1/2"	1-1/2"	1-1/2"	1-1/2"
75 - 100'	1-1/2"	1-1/4"	1-1/2"	1-1/2"	2"	1-1/2"
100 - 150'	1-1/2"	1-1/2"	2"	1-1/2"	2"	2"

WELL TO PUMP CONNECTION (SUCTION PIPE)

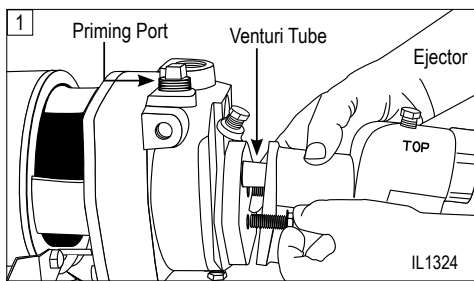

Shallow Well Application Only

⚠ CAUTION: Dry-fit entire assembly to ensure proper fit before gluing or taping parts.

Follow all proper gluing procedures as specified by the glue manufacturer. Always glue in a vertical direction whenever possible to prevent glue from dripping inside pipe or fittings. Use pipe tape and pipe paste compound on all male threads. Tighten with wrench to a snug fit and add another 1/4 turn to ensure proper seal.

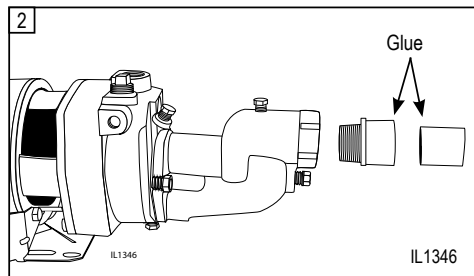

1. Attach ejector to face of pump with two (2) bolts and gasket provided. Venturi tube on the ejector inserts into the top tapping of the face of the pump (Fig. 1).

2. Make the connection to your well. Wrap all threaded fittings with pipe tape 5 times and then apply a pipe paste (pipe dope) to ensure an air tight connection (Fig. 2).

3. The use of a union (optional) will assist with easy connection and disconnect (Fig. 3).

4a. NOTE: For drilled (cased) wells, a foot valve is required in the well at the end of the pipe to maintain prime (Fig 4a).

4b. For driven wells, a check valve is required at the top of the well to maintain prime. Flow arrow must point toward pump (Fig. 4b).

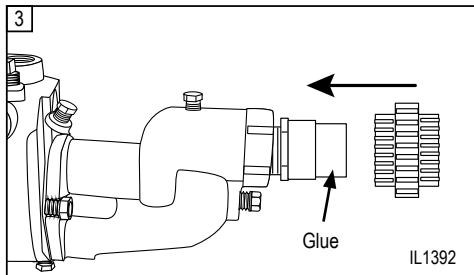

5. Finish the connection to your well with additional pipe and fittings as needed (Fig. 5).

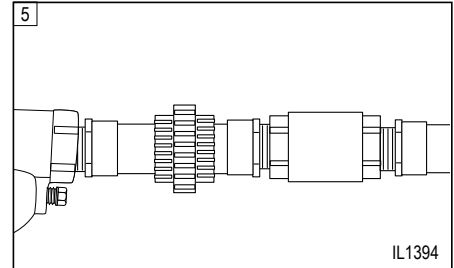
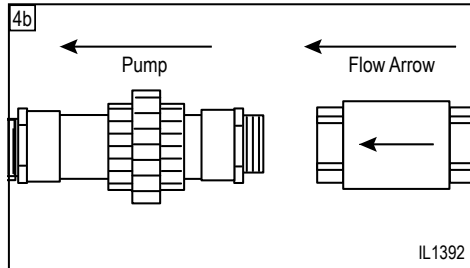
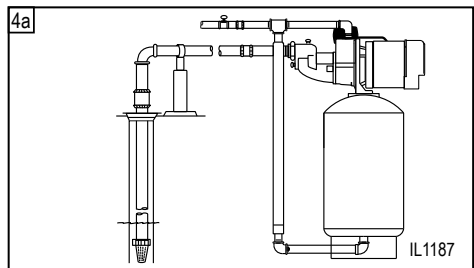

Deep Well Application Only

1. Make the connection to your well. Wrap all threaded fittings with pipe tape 5 times and then apply a pipe paste (pipe dope) to ensure an air tight connection (Fig. 1).

2. Finish the connection to your well with additional pipe and fittings as needed (Fig. 2).

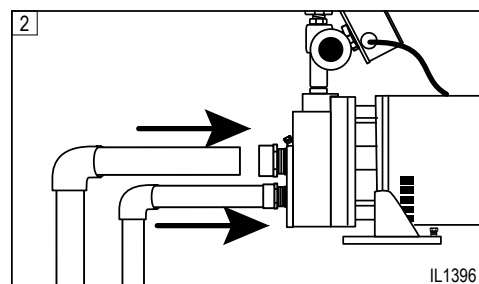
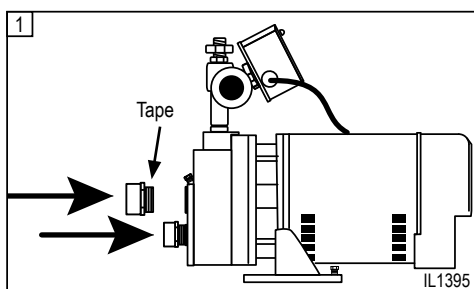

PUMP TO PRESSURE TANK CONNECTION (DISCHARGE PIPE)

Shallow Well Application Only

1. Begin the connection to the pressure tank. Using a 3/4 in. x 3 in. galvanized nipple, wrap the threads 5 times with pipe tape and apply pipe paste (pipe dope) and install in top of pump (Fig. 1).
2. Install a 3/4 x 3/4 x 3/4 in. galvanized tee fitting (Fig. 2).
3. Install a 3/4 in. MPT x 1/4 in. FPT galvanized bushing and pressure gauge (optional), or a pipe plug. Do not tighten, as you will prime your pump later at this location (Fig. 3).
4. Continue with fittings and pipe to the pressure tank. A 3/4 in. union (optional) for easy connection and disconnection (Fig. 4).

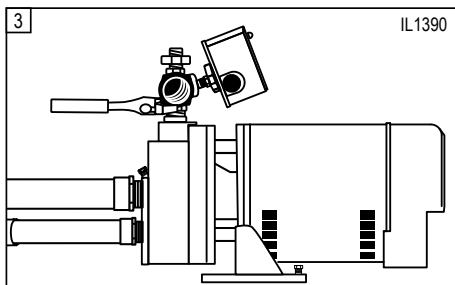
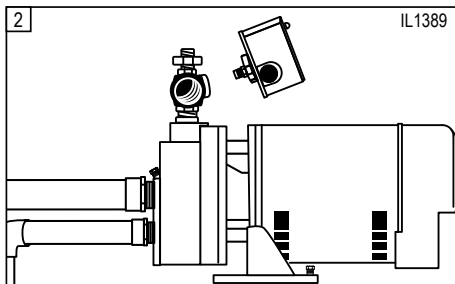
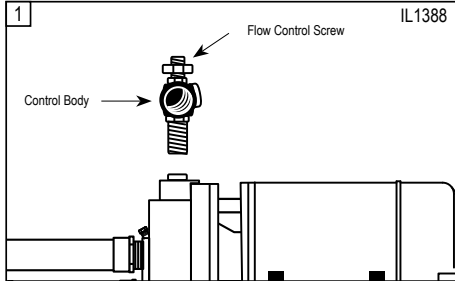
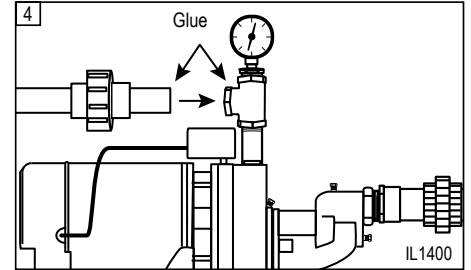
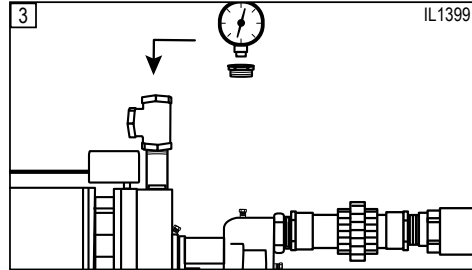
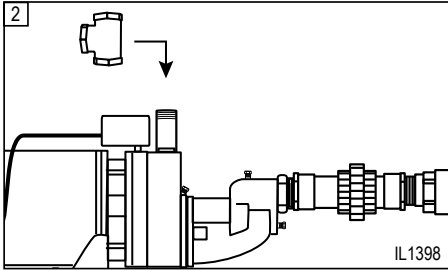
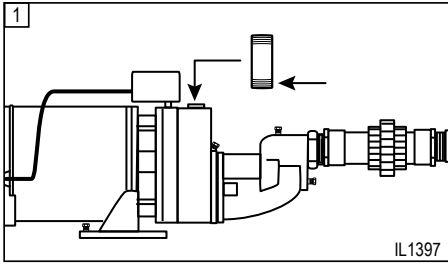

Deep Well Application Only

1. To begin the connection to the pressure tank, loosely assemble flow control body to pump head. Using Teflon tape, position the discharge outlet of the control body facing right as you look directly into the face of the pump (Fig. 1).
2. Assemble the pressure switch in the 1/4" tapping adjacent and to the right of the discharge outlet of the control valve (Fig. 2). Refer to Pump Electrical Connection section for pressure switch wiring.
3. Tighten flow control body (Fig. 3).
4. Install optional pressure gauge in 1/4" tapping on side of pump body. Face of gauge should be positioned so that dial can be read easily (Fig. 4).
5. Continue with fittings and pipe to the pressure tank. A 3/4 in. union is optional but recommended for easy connection and disconnection (Fig. 5).

CAUTION: Install a pressure relief valve on any installation where the pump pressure can exceed the maximum working pressure of the tank.

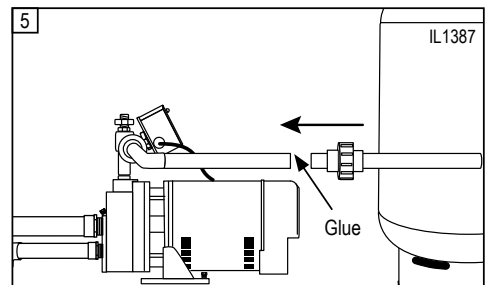
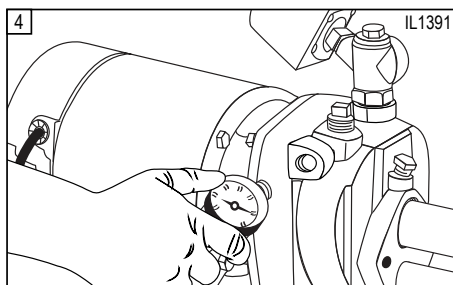

TANK TO HOUSE CONNECTION

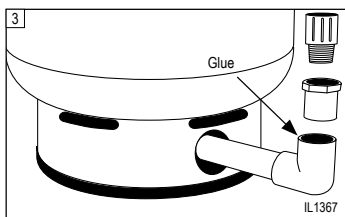
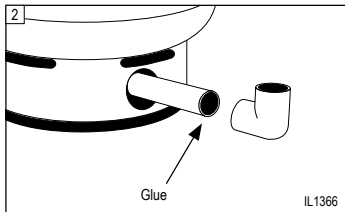
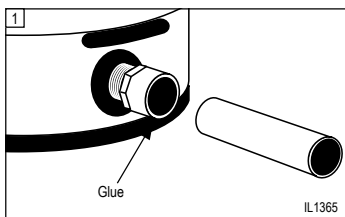

1. Most pressure tanks will have a 1 inch inlet elbow on the bottom. Connect to this elbow with a 1 in. MPT x 1 in. slip (glue) adapter and short piece of pipe (Fig. 1).

2. Install a 1 inch elbow (Fig. 2).

3. Attach a 1 in. slip (glue) x 3/4 in. FPT adapter and 3/4 in. MPT x 3/4 in. slip (Fig. 3).

4. Install a 3/4 in. union (optional) and continue with pipe and 3/4 in. x 3/4 in. x 3/4 in. tee (Fig. 4).

5. Make the connection to the house plumbing. From the tee, install pipe (Fig. 5) and shut off valve (optional).

6. Completed installation with piping and tank is shown (Fig. 6).

7. Optional tank-mounted system is shown. Connections are basically the same as explained in previous steps. (Fig. 7)

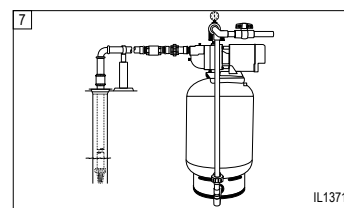
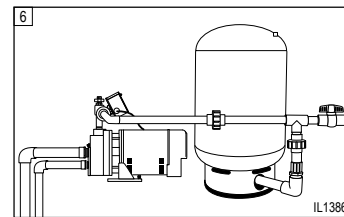
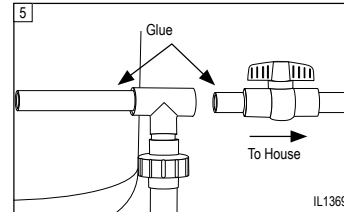
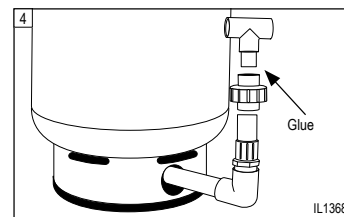

PUMP ELECTRICAL CONNECTIONS

CAUTION: All wiring should be performed by a qualified electrician in accordance with the National Electric Code and local electric codes. Connect the pump to a separate electrical circuit with a dedicated circuit breaker. Refer to the Wire Size Chart for proper fuse size. Protect the power cable from coming in contact with sharp objects. Make certain that the power source matches the pump requirements. This pump has a dual voltage motor and can run on 115V or 230V. 1/2 HP pumps are wired from the factory to run on 115V. 1 HP pumps are wired from the factory to run at 230V.

WARNING: The pump must be properly grounded using the proper wire cable with ground. Always disconnect pump from electricity before performing any work on the motor. Under-size wiring can cause motor failure and even fire. Use proper wire size specified in the Wire size chart. Replace damaged or worn wiring cord immediately. Do not kink power cable and never allow the cable to come in contact with oil, grease, hot surfaces, or chemicals.

Wiring The Pressure Switch

1. **CAUTION:** Make certain that the power source matches the pump requirements. This pump can run on 115V or 230V. See pump label for voltage prewired at the factory. (Fig. 1)

NOTE: To change Pump voltage, see wiring diagram on this page or step-by-step instructions on page 11.

Your pump motor has a built-in thermal overload that protects the motor against burnout from overload of low voltage, high voltage, and other causes. The device is automatic and resets itself once the temperature has dropped to a safe point. Frequent tripping of the device indicates trouble in the motor or power lines and immediate attention is needed.

WIRING DIAGRAM

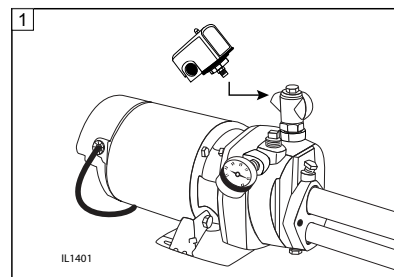
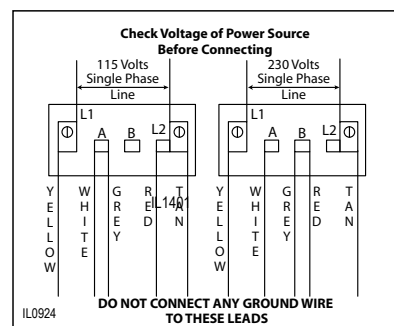

PUMP ELECTRICAL CONNECTIONS, CONTINUED

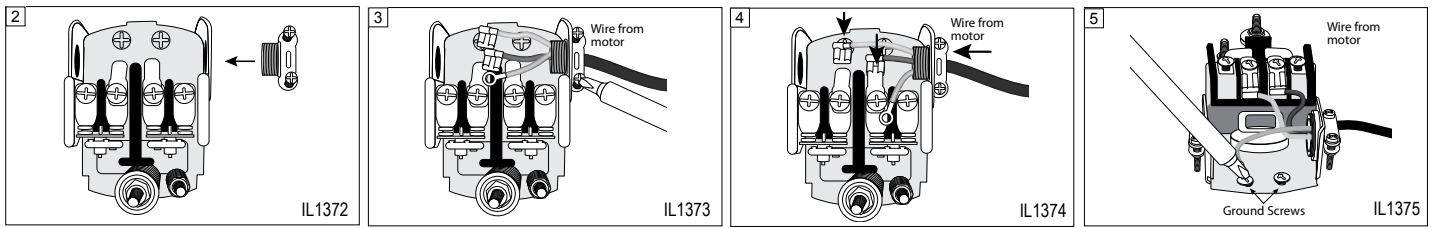

2. Insert an electrical wire strain relief into the opening in the side of the pressure switch closest to the motor (Fig. 2).
3. Thread the cable from the pump motor through the strain relief into the pressure switch cavity and tighten both screws on the strain relief. Do not crush wire (Fig. 3).
4. Connect the two motor wires of the motor cable to the two inside terminals on the pressure switch (Fig. 4).
5. Connect the green ground wire from the motor cable to one of the green ground screws at the bottom of the pressure switch (Fig. 5).

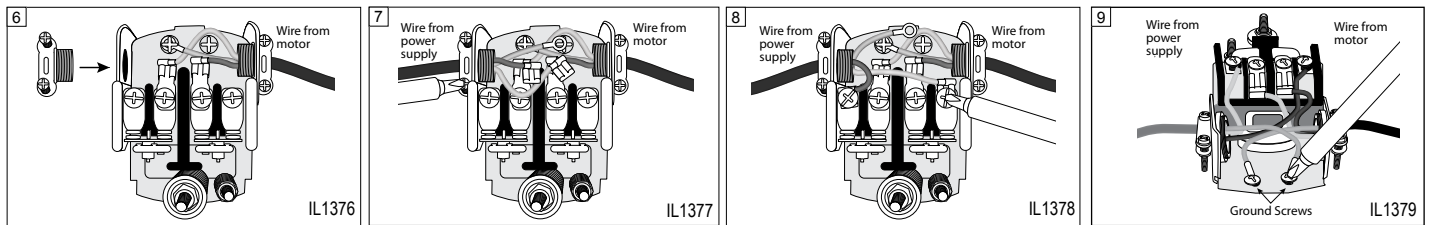

6. Insert an electrical wire strain relief into the opening in the opposite side of the pressure switch (Fig. 6).
7. Thread the cable from the power supply through the strain relief and tighten both screws on the strain relief. Do not crush wire (Fig. 7).
8. Connect the two wires from the power supply to the two outside terminals on the pressure switch (Fig. 8).
9. Connect the green ground wire from the power supply to the remaining green ground screw in the pressure switch and re-attach the pressure switch cover (Fig. 9).

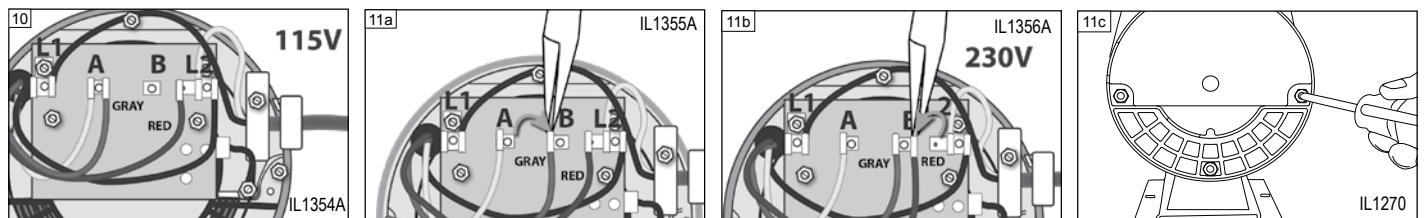

To change from 115V to 230V

10. The motor of this pump is dual voltage and can run on either 115V or 230V. In general, 230V is more economical to run, and requires a smaller wire size. The 1/2 HP model is factory preset to run at 115V (Fig. 10).

NOTE: 1 HP models are factory preset to operate at 230V.

11. For 230V service, change the following wires on the terminal board:
 - a. Using a pair of needle nose pliers, pull the gray wire with the female flag connector from the “A” terminal spade post. Place it to the right on the “B” terminal space post (Fig. 11a).
 - b. Pull the red wire with the female flag connector from the “L2” terminal. Place it to the left on the “B” terminal space post (Fig. 11b).
 - c. Reinstall the rear motor cover (Fig. 11c).

NOTE: To change 1 HP models to 115V, simply reverse instructions above.

PUMP PRIMING & STARTUP

Shallow Well Application Only

CAUTION: All pumps must be primed (filling the cavity with water) before they are first operated. This may take several gallons of water, as the suction line will be filled in addition to the pump cavity.

1. Remove the 1/2 in. priming plug with pressure gauge and air relief plug (Fig. 1).
2. Slowly fill pump cavity until water comes out of air relief hole on top of the pump (Fig. 2).

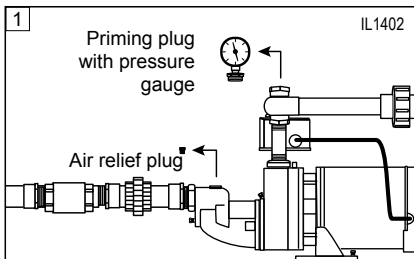

3. Replace air relief plug and continue adding water to pump cavity until water reaches the top of the priming plug (Fig. 3).
4. Check to be sure water in pump cavity stays constant. If water level goes down, it could indicate a leak in the foot valve, check valve or suction pipe.
5. Thread in priming plug and then open optional ball valve if installed by turning handle to line up with the pipe (Fig. 4).
6. Turn on breaker to start pump.

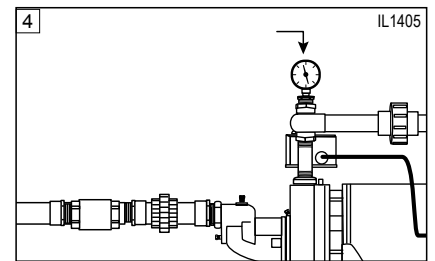
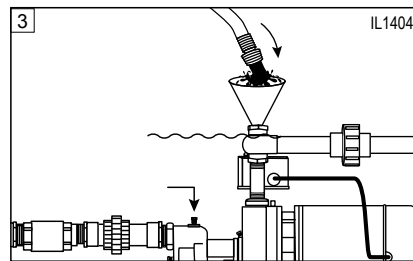
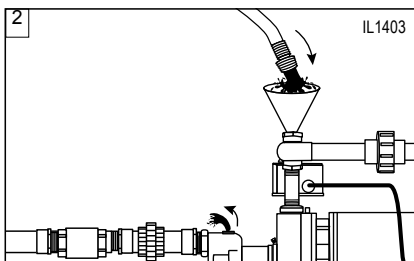

IMPORTANT: If the pump hums instead of pumping or turns off repeatedly, shut pump off immediately. Check voltage. Make sure your incoming voltage matches the pump wiring voltage. See wiring guide in the instructions.

NOTE: Watch for leaks or a milky color in the discharged water, which indicates an air leak. Make sure foot valve and/or check valve is working properly.

Deep Well Application Only

CAUTION: All pumps must be primed (filling the cavity with water) before they are first operated. This may take several gallons of water, as the suction line will be filled in addition to the pump cavity.

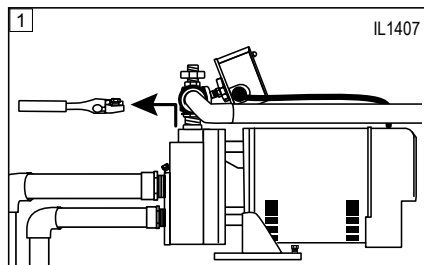

1. Remove the 1/2" priming plug (Fig. 1).
2. Fill pump cavity with water until full and replace priming plug (Fig. 2).
3. Tighten flow control screw completely by turning clockwise, then loosen two turns. Now start the pump (Fig. 3).
4. If pump is properly primed, pressure will quickly build and register on the gauge mounted directly on the pump body. If pressure does not build repeat priming operation. All air must be vented from the drive and suction pipes as well as the body before the pump will prime. The pump body may need to be filled several times in order to achieve the prime (Fig. 4).

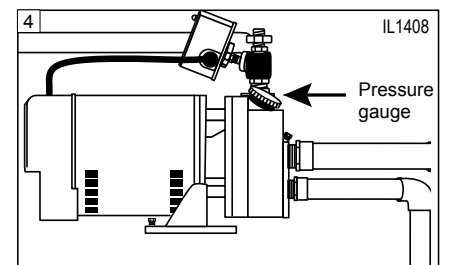
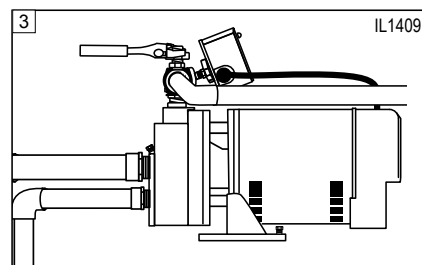
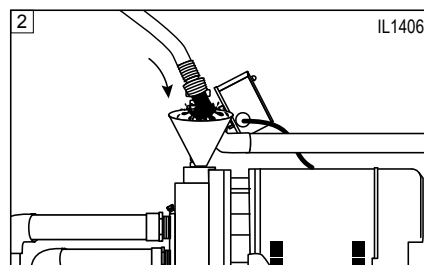

PUMP PRIMING & STARTUP, CONTINUED

5. With pump operating at high pressure, open two or more faucets and slowly unscrew the flow control screw until maximum flow is obtained. This steady pressure will be minimum operating pressure and should agree with the pressure shown below. The flow control screw diverts the proper amount of water to operate the ejector (Fig. 5).

HP	Pressure Setting
1/2	27 PSI
1	46 PSI

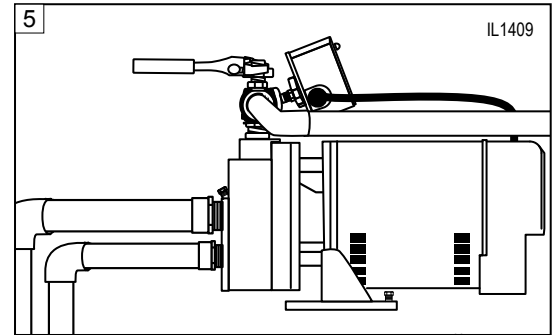

The correct control valve setting will depend on the type of well installation and pressure switch setting for the particular pump.

NOTE: If the pump is being used for shallow well applications, the flow control screw should be set in the full open position.

! **IMPORTANT:** If the pump fails to prime within five minutes: Turn power off at the breaker box. Look for leaks or a milky color in the discharged water, which indicates an air leak. Re-prime if necessary, following steps 1 through 5 above. Reset breaker at the breaker box. All connections must be water and air tight in order for pump to operate.

CARE AND MAINTENANCE

Winterizing

! **CAUTION:** Drain the entire system if there is danger of freezing. A drain plug is provided at the bottom of the pump case for this purpose.

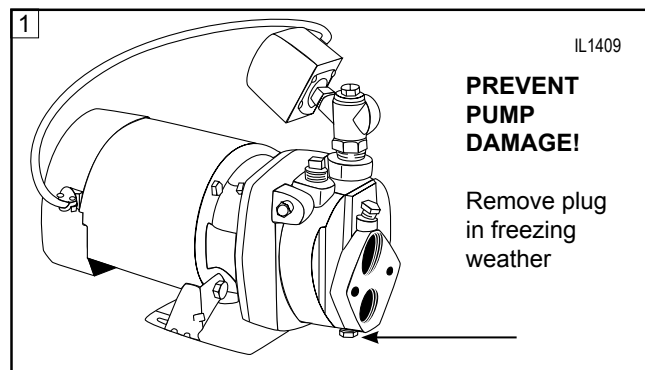

SEAL ASSEMBLY AND MOTOR REPLACEMENT

ROTARY SEAL ASSEMBLY REPLACEMENT

▲ CAUTION Make certain that the power supply is disconnected before attempting to service the unit! The rotary seal assembly must be handled carefully to avoid damaging the precision lapped faces of the sealing components.

1. Disengage pump body (Ref. No. 10) from motor mounting ring (Ref. No. 2).
2. Remove diffuser (Ref. No. 6).
3. To remove the impeller use a 9/16" open end wrench to hold the motor shaft. On Uni-frame motors, remove the rear cover, the flat area is located between the governor and rear bearing. On Nema J motors, the shaft flat area is located in the middle of the mounting ring. Uni-frame or Nema J motors are indicated by 56U or 56J respectively in the frame "FR" block on the motor decal.
4. The rotary seal (Ref. No. 4) will come loose at this time. Use a screwdriver (or similar instrument) to pry the ceramic seal and rubber gasket from the recess of the mounting bracket.

▲ CAUTION Be careful not to damage the motor shaft or recess surface.

5. Clean the recess and motor shaft thoroughly.
6. Install the new rotary seal assembly.
 - a. Insert the ceramic seal and the rubber gasket into the recess.**NOTE:** To help facilitate installation, apply a drop of liquid soap to the outside diameter of the rubber gasket. Make certain that the ceramic seal is kept clean and free of dirt and/or oil.
 - b. Slip the remaining parts of the rotary seal assembly onto the motor shaft.**NOTE:** Apply a drop of liquid soap to the inside diameter of the rubber drive ring.
7. Replace the impeller and diffuser removed in Steps 2 & 3.
8. Reassemble the pump body to the motor and mounting bracket.

MOTOR REPLACEMENT (Figure 5)

1. Uni-Frame motors can be replaced in the field with any standard Nema J jet pump motor by following the instructions below.

▲ CAUTION Before attempting to replace the motor, make certain that the power supply is disconnected and the system pressure is relieved.

2. Remove pump body (Ref. No. 10), diffuser (Ref. No. 6), impeller (Ref. No. 5), and shaft seal (Ref. No. 4) by following steps 1, 2, 3 & 4 of Rotary Seal Replacement.
3. Uni-Frame motors (indicated by 56U in the frame "FR" block on the motor decal) can be removed as follows:
 - a. Disassemble pump base (Ref. No. 14) from unit by removing two (2) 3/8" hex nuts.
 - b. Remove four (4) thru bolts from rear of motor and pull away shell and stator assembly (discard).
 - c. Disconnect four (4) self tapping screws that hold the bearing housing to the mounting ring. Discard bearing housing, rotor assembly and (2) square headed screws.
4. Replace motor with standard Nema J jet pump motor by positioning motor against the mounting frame and assembling with four (4) 3/8" x 3/4" cap screws. The mounting base is connected at the bottom of the mounting frame with two (2) of the four (4) 3/8" x 3/4" cap screws.
5. Follow steps 5, 6, 7 and 8 of Rotor Seal Assembly to reassemble the remainder of the pump. Because damage to the shaft seal is most likely to occur in disassembly, a new seal will be necessary.

NOTE: The pumps and motors require no lubrication. The ball bearings of the motor have been greased at the factory and under normal operating conditions should require no further greasing.

FIGURE 11

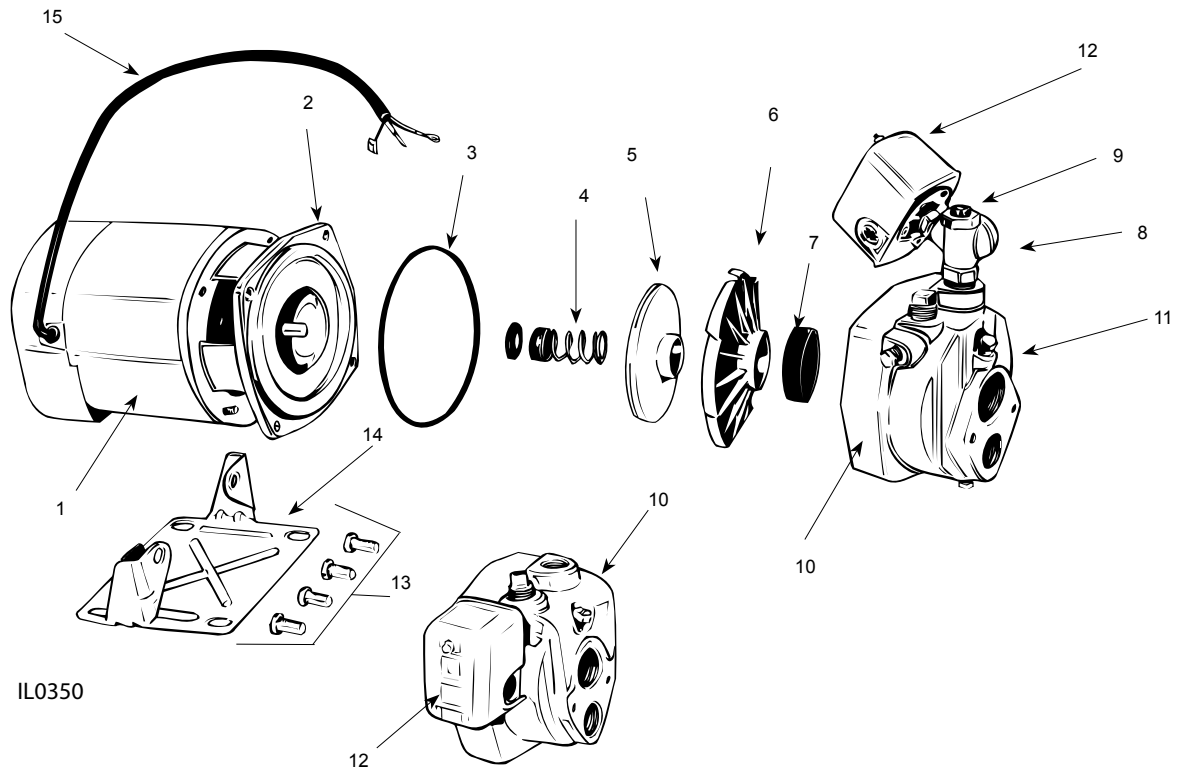

IL0350

HORSEPOWER			1/2	1
"CONV" CONVERTIBLE MODEL NO.			462-0006	463-0006
ITEM	DESCRIPTION	QTY.	PART NO.	PART NO.
1	Motor, NEMA J	1	98J105	98J110
2	Mounting Ring	1	134162	134163
3	Ring, Square Cut	1	132583	132429
4	Seal, Rotary w/Spring	1	131100	131100
5	Impeller	1	139349	134138
6	Diffuser	1	132424	132425
7	Rubber, Diffuser	1	132428	132428
8 & 9	Control Assembly	1	134349	134349
8	Control Body	1	135019	135019
9	Flow Control Screw	1	124330	124330
10	Pump Body	1	134121	134123
11	Plug 1/4" NPT	3	*	*
12	Pressure Switch	1	020345	020345
13	Cap Screws, 3/8 x 3/4"	8	*	*
14	Base	1	128034	128034
15	Lead Wire	1	136135A	136135A

(*) Standard hardware item

TROUBLESHOOTING

Symptom	Possible Cause(s)	Corrective Action
Pump won't start or run.	<ol style="list-style-type: none"> Blown fuse. Low line voltage. Loose, broken or incorrect wiring. Defective motor. Defective pressure switch. Impeller or seal. Bad capacitor. 	<ol style="list-style-type: none"> If blown, replace with fuse of proper size. Use time delay fuses. If voltage under recommended minimum, check size of wiring from main switch on property. If OK, contact power company. Rewire any incorrect circuits. Tighten connections, replace defective wires. Replace. Adjust switch settings. Clean contacts with emery cloth if dirty. If impeller won't turn, remove housing and locate source of binding. Replace.
Pump starts and stops too often.	<ol style="list-style-type: none"> Leak in pressure tank. Defective air volume control. Faulty pressure switch. Leak on discharge side of system. Leak on suction side of system. Leak in foot valve. 	<ol style="list-style-type: none"> Repair leaks or replace tank. Clean or replace defective control. Adjust switch settings. Clean contacts with emery cloth if dirty. Repair leaks as necessary. Make sure above ground connections are tight. Then repeat test. If necessary, pull piping and repair leak. Repair or replace.
Pump won't shut off.	<ol style="list-style-type: none"> Wrong pressure switch setting or setting "drift". Defective pressure switch. Loss of prime. Low well level. Fouled ejector. 	<ol style="list-style-type: none"> Adjust switch to proper setting. Replace switch if defective. Reprime if necessary. If undersized, replace pump or ejector. Clean.
Pump operates, but delivers little or no water.	<ol style="list-style-type: none"> Low line voltage. System incompletely primed. Air lock in suction line. Undersized piping. Leak in air volume control or tubing. Leak on suction side of system. Low well capacity. Plugged ejector. Defective or plugged foot valve and/or strainer. Worn or defective pump parts or plugged impeller. 	<ol style="list-style-type: none"> If voltage under recommended minimum, check size of wiring from main switch on property. If OK, contact power company. Reprime if necessary. Rearrange piping to eliminate air lock. Replace undersized piping or install pump with higher capacity. Tighten all fittings and replace control if necessary. Make sure above ground connections are tight. Repeat test. If necessary, pull piping and repair leak. Close down the valve on discharge side of pump to limit flow of water, in keeping with well capacity. Clean and reinstall if dirty. Clean, repair or replace as needed. Replace worn parts or pump. Clean parts if required.
Little or no discharge	<ol style="list-style-type: none"> Casing not initially filled with water Suction lift too high, or too long Hole or air leak in suction line Foot valve too small Foot valve or suction line not submerged deep enough in water Motor wired incorrectly Casing gasket leaking Suction or discharge line valves closed 	<ol style="list-style-type: none"> Fill pump casing Move pump closer to water source Repair or replace. Use pipe tape and pipe sealing compound Match foot valve to piping or install one size larger foot valve. Submerge lower in water Check wiring diagram Replace Open
Pump will not deliver water or develop pressure	<ol style="list-style-type: none"> No priming water in casing Leak in suction line Discharge line is closed and priming air has nowhere to go. Suction line (or valve) is closed Foot valve is leaking Suction screen clogged 	<ol style="list-style-type: none"> Fill pump casing Repair or replace Open ball valve Open Replace foot valve Clean or replace
Loss of suction	<ol style="list-style-type: none"> Air leak in suction line Suction lift too high Insufficient inlet pressure or suction head Clogged foot valve or strainer 	<ol style="list-style-type: none"> Repair or replace Lower suction lift, install foot valve and prime Increase inlet pressure by adding more water to tank or increasing back pressure Unclog
Pump vibrates and/or makes excessive noise	<ol style="list-style-type: none"> Mounting plate or foundation not rigid enough Foreign material in pump Impeller damaged Worn motor bearings 	<ol style="list-style-type: none"> Reinforce Disassemble pump and clean Replace Replace



MAIL TO: P.O. BOX 16347 • Louisville, KY 40256-0347
 SHIP TO: 3649 Cane Run Road • Louisville, KY 40211-1961
 (502) 778-2731 • 1 (800) 928-PUMP • FAX (502) 774-3624

Visit our web site:
zoellerpumps.com

Trusted. Tested. Tough.™